

SPS SERIES (SONITRON Polymer/metal Speakers)



INTRODUCTION

Based on the in-house expertise in vibration characteristics of piezoceramic material and micro-acoustics, Sonitron successfully developed the SPS-series piezoceramic speakers for industrial, multimedia and automotive applications. The SPS-series is based on a completely new principle of piezoceramics and a composite polymer/metal membrane. The composite polymer/metal membrane reduces unwanted resonance peaks to provide a more even frequency response than can be achieved with conventional designs. High sound quality and low distortion guarantee perfect reproduction of music and speech.

Piezoceramic speakers offer a faster response than conventional magnet speakers because of their lower mass (no voice coil). Magnet speakers are less efficient than piezo speakers because of the losses via the voice coil. Piezoceramic speakers also feature a low weight and low energy consumption relative to their sound output levels. They do not generate an electromagnetic field, making it easier for designers to ensure that their products meet EMC requirements and regulations.

Sonitron's SPS speakers have a very flat design and are delivered with an open front. They can be used in difficult environmental conditions and applications because of resistance of the front to water, humidity, vibrations and dust.

The described models are released for applications such as mobile phone, PDA, flat LCD computer screens and computer monitors, consumer products, car audio, instrumentation, portable devices, public address systems, paging systems, etc.

SPS Series

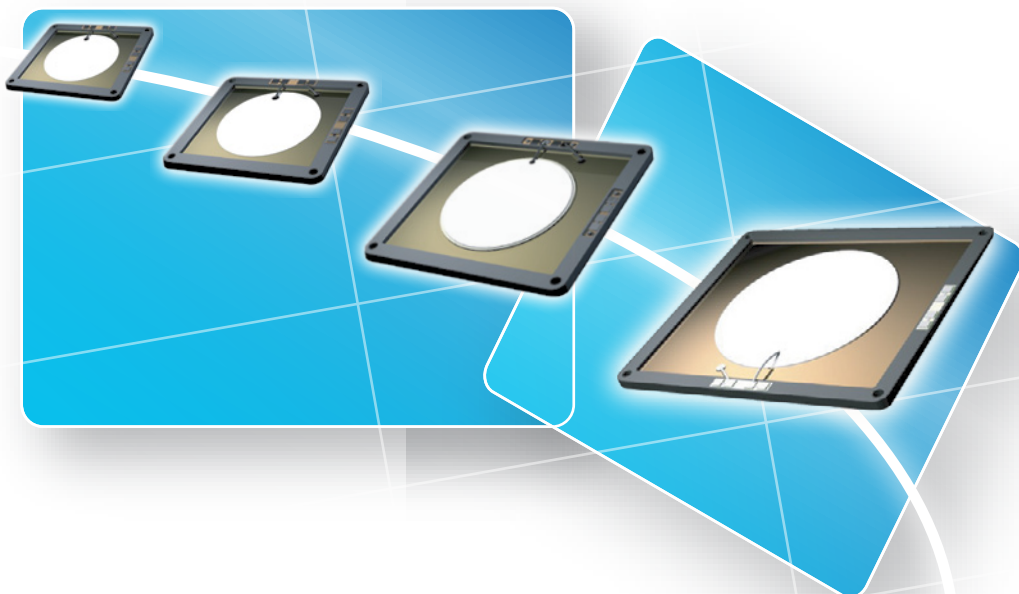

ADVANTAGES & APPLICATIONS

ADVANTAGES :

- very flat and solid construction
- dust, water- and shockproof
- resistant to temperature variations
- broad frequency range in small size
- combined use as speaker/micro
- no electro-magnetic field (EMC)
- little energy required at low frequencies
- less current consumption needed in the leads to the speaker
- 60% higher acoustic output for smaller speakers compared to electrodynamic speakers
- low weight
- low distortion
- high impedance
- can be driven directly by IC

APPLICATIONS :

- home equipment & domotics
- communication equipment
- talking buzzer & door bell
- computer equipment
- cars, busses and trains
- vending machines
- multimedia equipment
- industrial equipment
- portable voice recorders
- paging systems
- public address systems
- instrumentation
- mobile phone
- car audio system

SPECIFICATIONS

Model	Operating voltage (Vac pp)	Frequency range (Hz)	Max. SPL dB @ 1m, average 4 points	Applications	Capacitive load	Dimensions mm (LxWxH)
SPS-2220-03	1-24	700-20000	85*	GSM, GPS, MP3, camera,...	70nF	22x20x2
SPS-3530-03	5-60	700-20000	81	PDA, GPS, notebooks,...	220nF	43.5x39x2
SPS-4640-03	5-60	400-20000	83	PDA, GPS, notebooks,...	225nF	50x43.6x2
SPS-6555-03	5-60	300-20000	83	Multimedia,...	480nF	65x55x2
SPS-8770-03	5-60	200-20000	84	Computers,...	580nF	87x70x2

*@10 cm, designed for headphone applications!

IMPEDANCE

Theoretical the main impedance of the piezo speakers is a capacitive reactance and follows an asymptotic function.

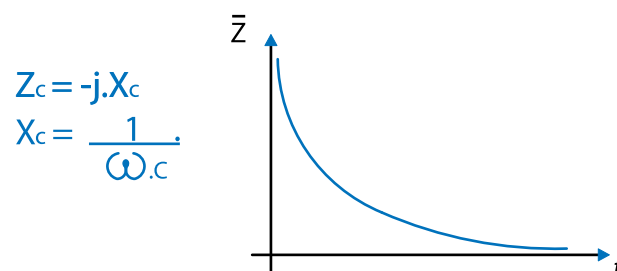

The typical practical impedance values ($\pm 20\%$) for frequencies of 100 Hz up to 20 kHz of our speakers are as follows:

Model	SPS-2220-03	SPS-3530-03	SPS-4640-03	SPS-6555-03	SPS-8770-03
Capacitance ($\pm 20\%$)	70 nF	220 nF	225 nF	480 nF	580 nF
Z @ 100 Hz	22360 ohm	5714 ohm	6210 ohm	3845 ohm	2314 ohm
Z @ 1 kHz	2162 ohm	603 ohm	680 ohm	445 ohm	266 ohm
Z @ 2 kHz	1183 ohm	311 ohm	360 ohm	223 ohm	133 ohm
Z @ 5 kHz	497 ohm	127 ohm	143 ohm	92 ohm	54 ohm
Z @ 10 kHz	245 ohm	65 ohm	73 ohm	45 ohm	28 ohm
Z @ 15 kHz	168 ohm	43 ohm	49 ohm	31 ohm	19 ohm
Z @ 20 kHz	125 ohm	32 ohm	37 ohm	23 ohm	14 ohm

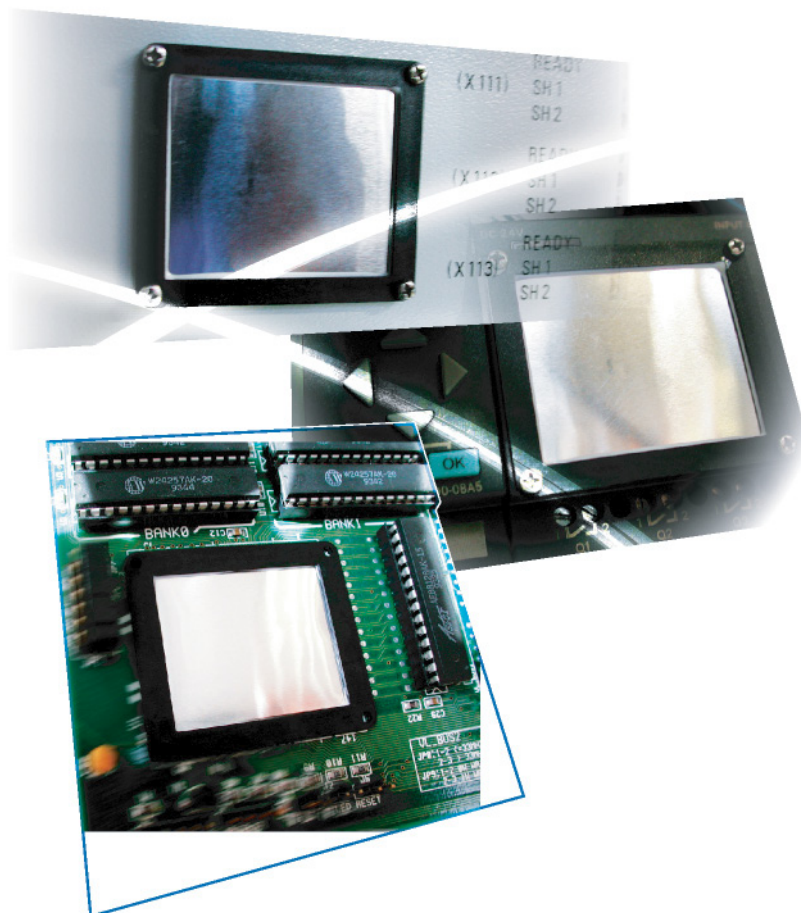

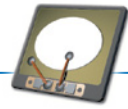

SPS-2220-03



Sonitron's latest slim line profile speaker, the SPS-2220-03, is the result of ten years intensive research and development work. With a thickness of only 1 mm and dimensions of 20x22 mm, this small multifunctional speaker/microphone is ideal for use in GPS, MP3, camera's, mobile phones,... It is distortion free and has excellent sound reproduction. Considering its extremely good voice clarity it definitely is the new speaker generation for the mobile phone industry.

SPECIFICATIONS

Frequency Range :	700 Hz-20 kHz
Max SPL @ 10 cm, 24Vpp: (average at 4-point)	85 dB
Distortion (%THD): (80dB @ 5 cm, average @ 4-point)	≤1%
Sensitivity: (SPL @ 10cm for 1Vrms, average at 4-point : 800Hz, 1kHz, 1.5kHz, 2kHz)	63 dB
Capacitance (+/- 20%):	70 nF
Impedance @ 1kHz (+/-20%):	2.16 kohm
Operating Voltage:	1Vpp-24Vpp
Weight:	0.4g
Operating Temperature:	-20°C to 60°C
Storage Temperature:	-40°C to 60°C
Case material:	PC
Standard color:	Black

speaker mounted on plexi plate of 5 x 5cm in closed box of 40 x 15 x 5cm

FREQUENCY RESPONSE

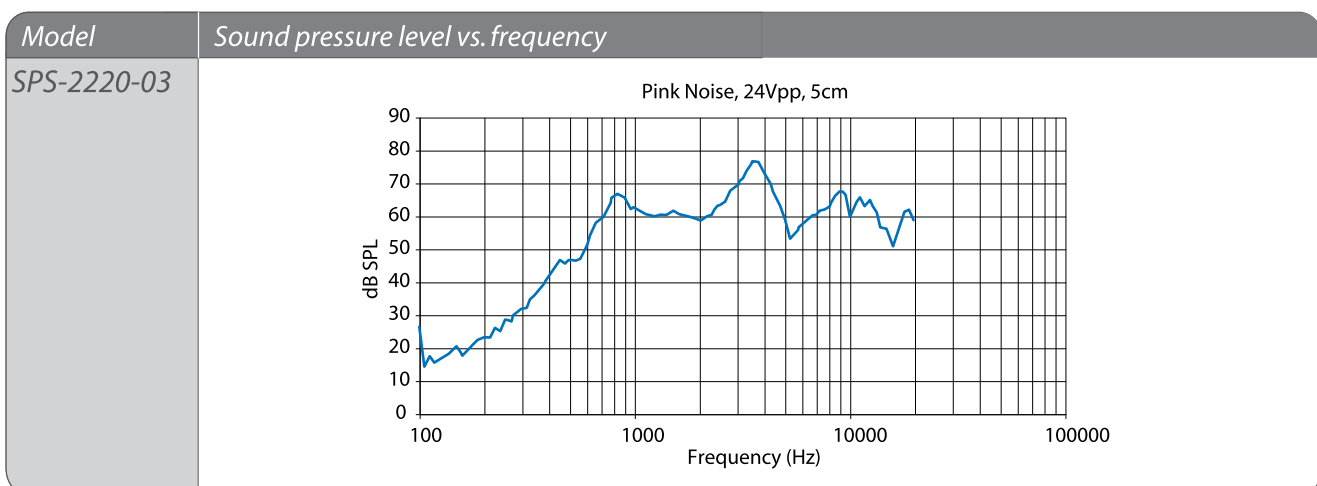

DIMENSIONS (all dimensions are in mm)

SPS-2220-03

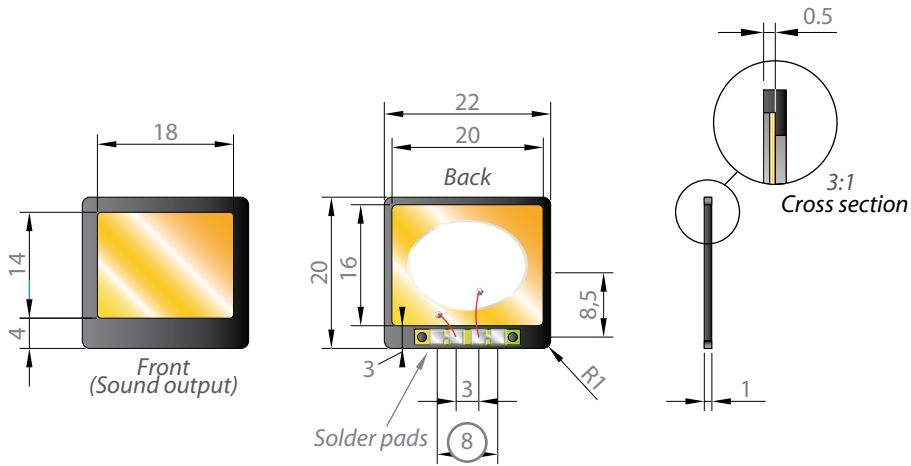

Tolerance: +/- 0.2mm mm

Recommended Piezo Audio Amplifiers

Integrated Circuits

Maxim
MAX9788

Texas Instruments
TPA2100P1

Linear technology
LT3469

Sonitron production models

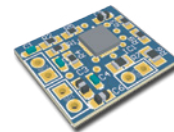

PAA-MAX-9788-01

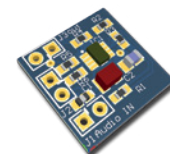

PAA-LT3469-01

SPS-3530-03

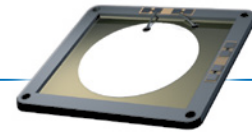

The electronics industry still is a very demanding industry which requires more and more flat and small components. Therefore Sonitron developed this new flat piezoceramic speaker. With a thickness of only 2 mm and dimensions of 39x43.5 mm, this small multifunctional speaker/microphone is ideal for use in portable electronic devices (PDA, GPS, MP3,...), notebooks and consumer products.

SPECIFICATIONS

Frequency Range :	700 Hz - 20 kHz
Max SPL @ 1 m, 60 Vpp: (average at 4-point)	81 dB
Distortion (%THD): (80dB @ 5 cm, average @ 4-point)	≤1.5%
Sensitivity: (SPL @ 10cm for 1Vrms, average @ 4-point : 800Hz, 1kHz, 1.5kHz, 2kHz)	73 dB
Capacitance (+/- 20%):	220 nF
Impedance @ 1kHz (+/-20%):	603 ohm
Operating Voltage:	5-60 Vpp
Weight:	2.4g
Operating Temperature:	-20°C to 60°C
Storage Temperature:	-40°C to 60°C
Case material:	PC
Standard color:	Black

speaker mounted in closed box of 40 x 15 x 5cm

FREQUENCY RESPONSE

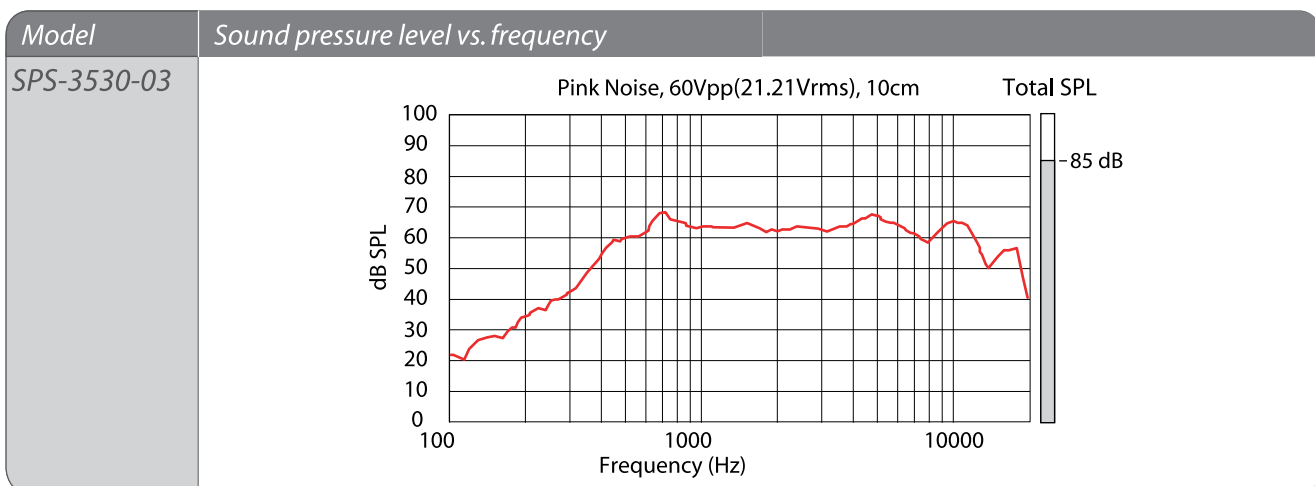

DIMENSIONS (all dimensions are in mm)

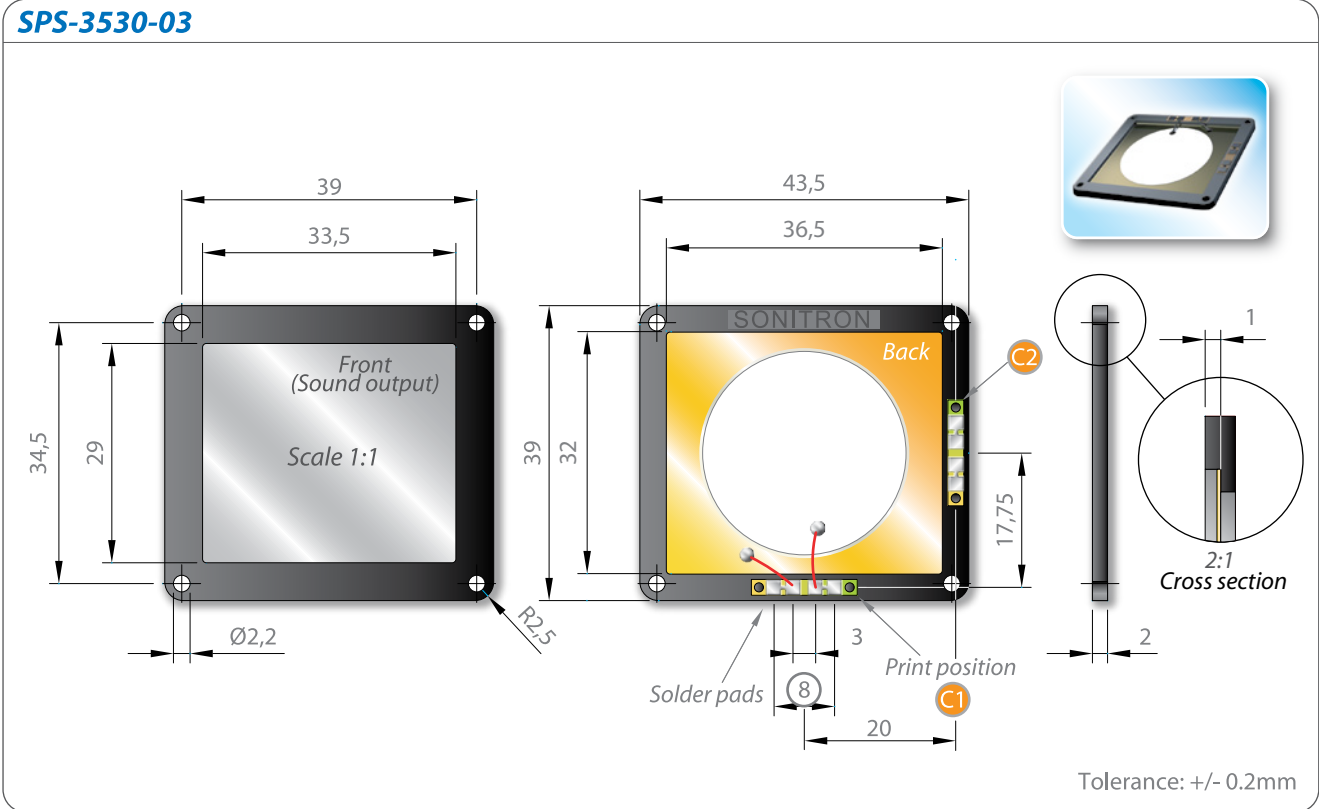

Recommended Piezo Audio Amplifiers (see page 104, 105, 106)

Integrated Circuits

Maxim
MAX9788

National semiconductor
LM4960

Texas Instruments
TPA2100P1

Sonitron production models

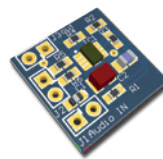

PAA-LT3469-01

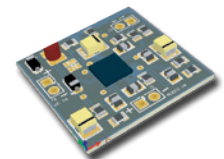

PAA-LM4960SQ-02

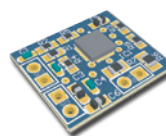

PAA-MAX-9788-01

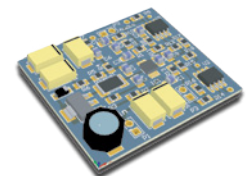

PAA-StepUpBTL-01

SPS-4640-03

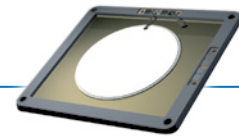

The electronics industry still is a very demanding industry which requires more and more flat and small components. Therefore Sonitron developed this new flat piezoceramic speaker. With a thickness of only 2 mm and dimensions of 43.6x50 mm this small multifunctional speaker/microphone is ideal for use in portable electronic devices (PDA, GPS, MP3,...), notebooks and consumer products.

SPECIFICATIONS

Frequency Range :	400 Hz - 20 kHz
Max SPL @ 1 m, 60 Vpp: (average @ 4-point)	83 dB
Distortion (%THD): (80dB @ 5 cm, average @ 4-point)	≤1.5%
Sensitivity: (SPL @ 10cm for 1Vrms, average @ 4-point : 800Hz, 1kHz, 1.5kHz, 2kHz)	72 dB
Capacitance (+/- 20%):	225 nF
Impedance @ 1kHz (+/-20%):	680 ohm
Operating Voltage:	5-60 Vpp
Weight:	2.8g
Operating Temperature:	-20°C to 60°C
Storage Temperature:	-40°C to 60°C
Case material:	PC
Standard color:	Black

speaker mounted in closed box of 40 x 15 x 5cm

FREQUENCY RESPONSE

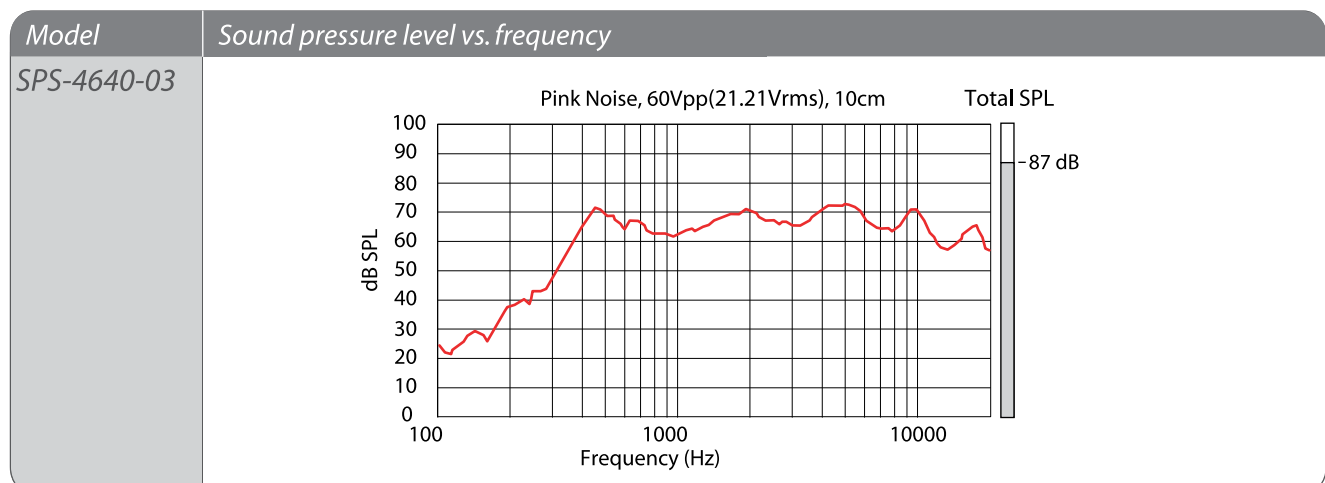

DIMENSIONS (all dimensions are in mm)

SPS-4640-03

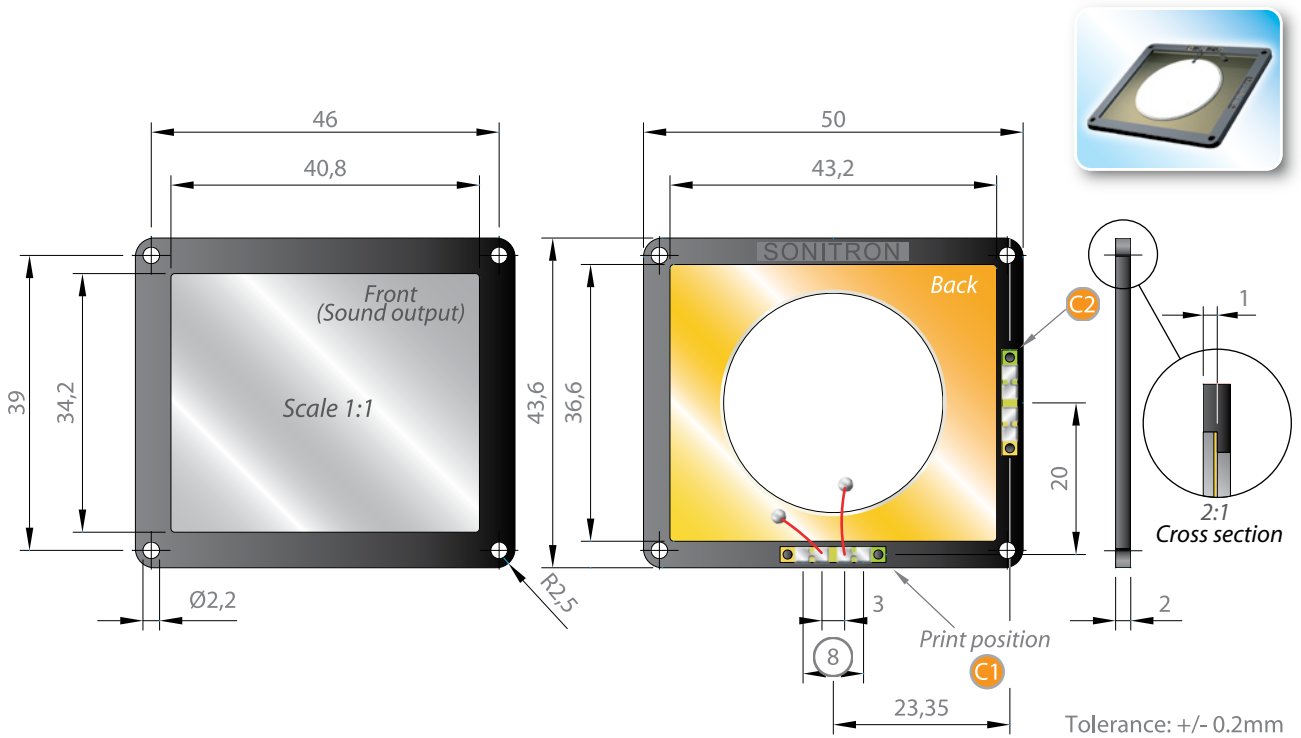

Recommended Piezo Audio Amplifiers (see page 104, 105, 106)

Integrated Circuits

Maxim
MAX9788

National semiconductor
LM4960

Texas Instruments
TPA2100P1

Sonitron production models

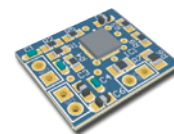

PAA-MAX-9788-01

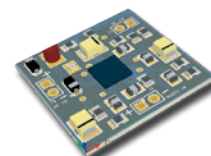

PAA-LM4960SQ-02

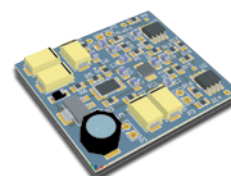

PAA-StepUpBTL-01

SPS-6555-03



The new SPS-6555-03 is designed for applications where the space is limited and a high sound quality is required. This new speaker model features a broad frequency range combined with small dimensions which makes them ideal for multimedia applications.

SPECIFICATIONS

Frequency Range :	300 Hz - 20 kHz
Max SPL @ 1 m, 60 Vpp: (average @ 4-point)	83 dB
Distortion (%THD): (80dB @ 1m, average @ 4-point)	≤1.5%
Sensitivity: (SPL @ 10cm for 1Vrms, average @ 4-point : 800Hz, 1kHz, 1.5kHz, 2kHz)	73 dB
Capacitance (+/- 20%):	480 nF
Impedance @ 1kHz (+/-20%):	333 ohm
Operating Voltage:	5-60 Vpp
Weight:	5g
Operating Temperature:	-20°C to 60°C
Storage Temperature:	-40°C to 60°C
Case material:	PC
Standard color:	Black

speaker mounted in closed box of 40 x 15 x 5cm

FREQUENCY RESPONSE

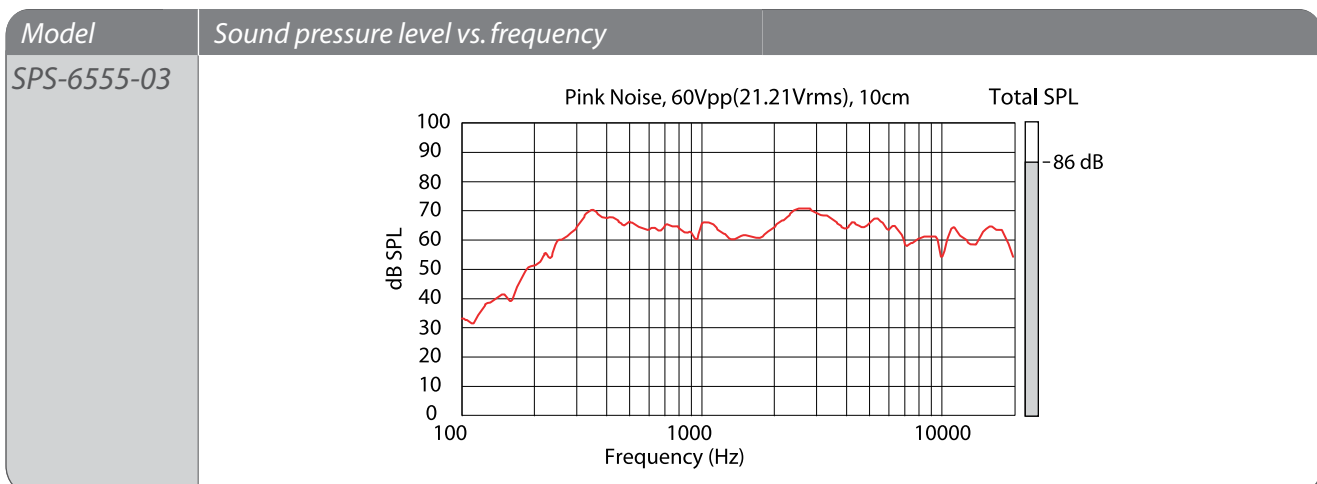

DIMENSIONS (all dimensions are in mm)

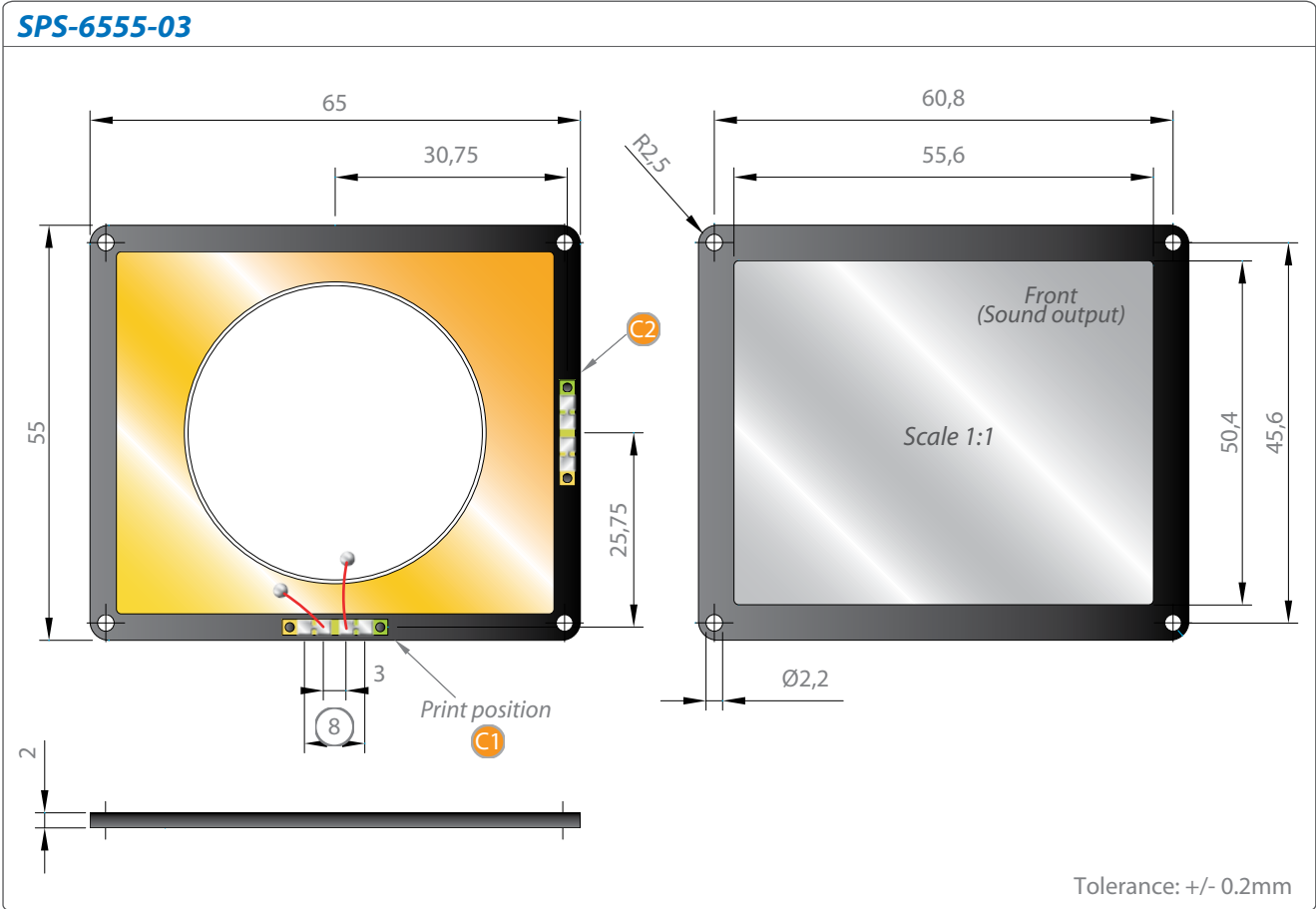

Recommended Piezo Audio Amplifiers (see page 104, 105, 106)

Integrated Circuits

Maxim
MAX9788

National semiconductor
LM4960

Texas Instruments
TPA2100P1

Sonitron production models

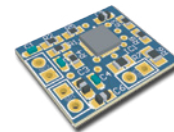

PAA-MAX-9788-01

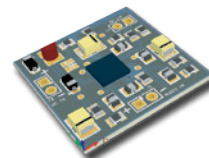

PAA-LM4960SQ-02

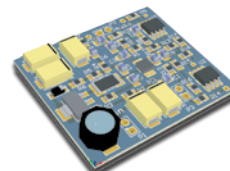

PAA-StepUpBTL-01

SPS-8770-03

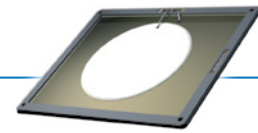

The SPS-8770-03 is the largest version of our piezo speakers, with a thickness of only 2 mm. This model is extremely suitable for flat devices when high sound output and broad frequency range are required. Low weight and easy mounting requirements are the extreme advantages of this speaker. Compared with conventional designs the speaker also has less current consumption.

SPECIFICATIONS

Frequency Range :	200 Hz - 20 kHz
Max SPL @ 1 m, 60 Vpp: (average @ 4-point)	84 dB
Distortion (%THD): (80dB @ 5 cm, average @ 4-point)	≤1.5%
Sensitivity: (SPL @ 10cm for 1Vrms, average @ 4-point : 800Hz, 1kHz, 1.5kHz, 2kHz)	74 dB
Capacitance (+/- 20%):	580 nF
Impedance @ 1kHz (+/-20%):	266 ohm
Operating Voltage:	5-60 Vpp
Weight:	7.3g
Operating Temperature:	-20°C to 60°C
Storage Temperature:	-40°C to 60°C
Case material:	PC
Standard color:	Black

speaker mounted in closed box of 40 x 15 x 5cm

FREQUENCY RESPONSE

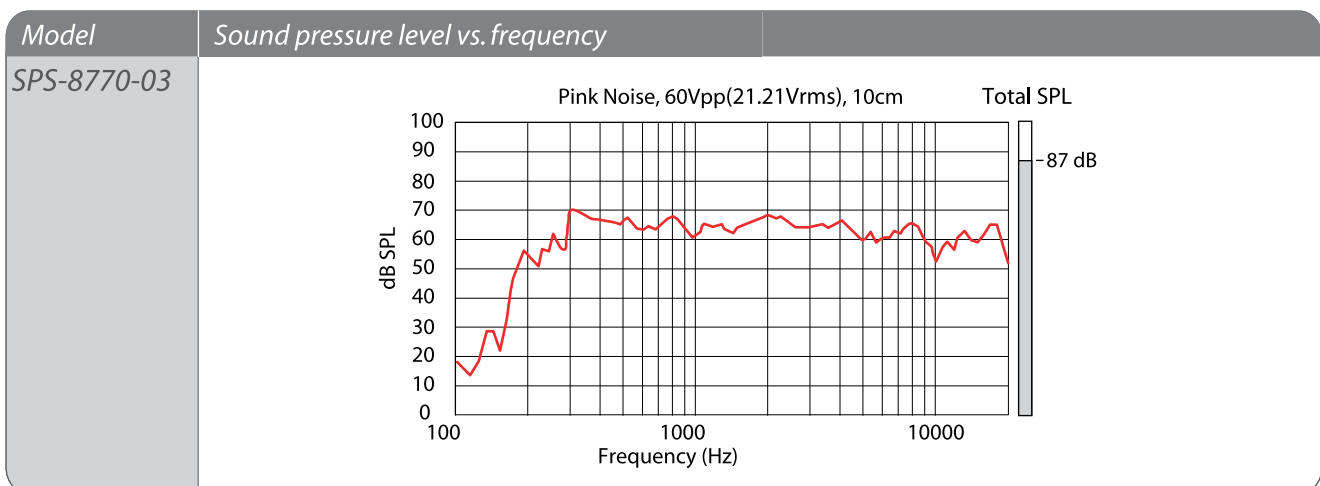

DIMENSIONS (all dimensions are in mm)

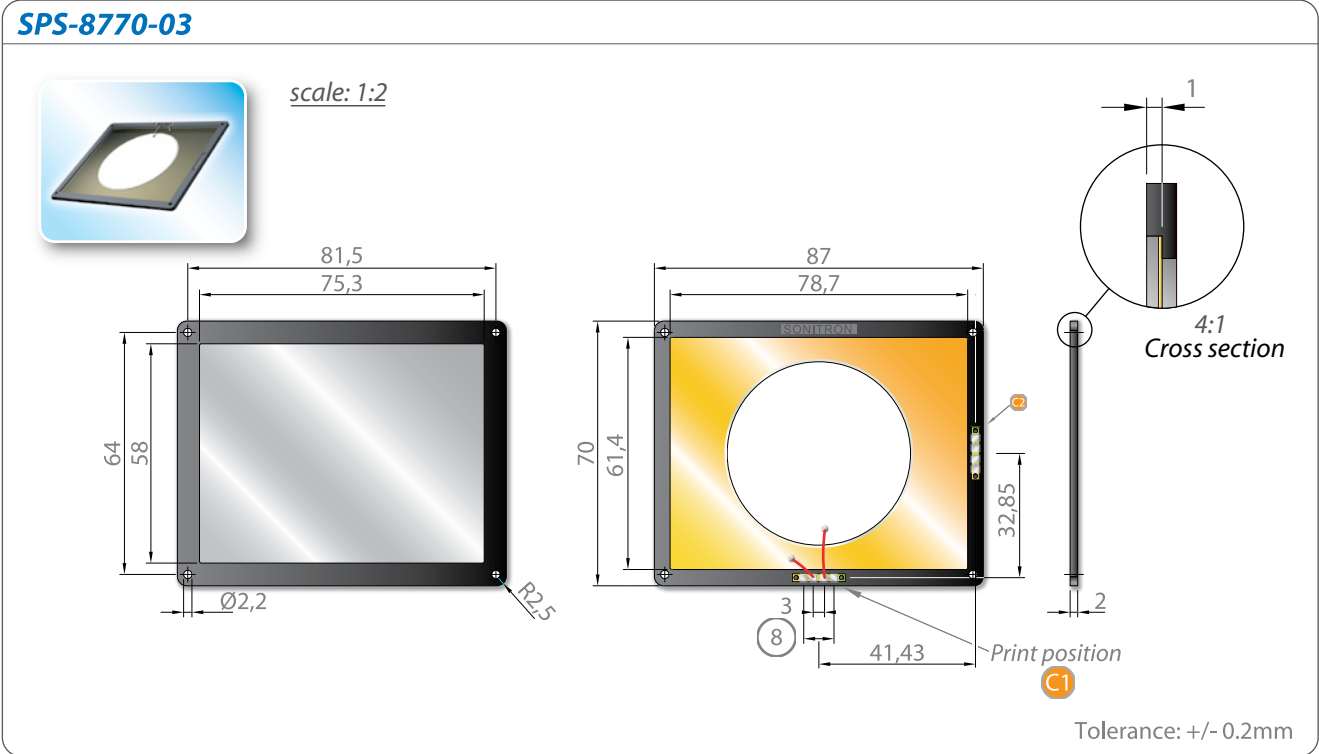

Recommended Piezo Audio Amplifiers (see page 104, 105, 106)

Integrated Circuits

Maxim
MAX9788

National semiconductor
LM4960

Texas Instruments
TPA2100P1

Sonitron production models

PAA-MAX-9788-01

PAA-LM4960SQ-02

PAA-StepUpBTL-01

PRODUCT CODIFICATION

<p>SPS</p> <p>↓</p> <p>Sonitron Polymer/metal Speaker</p>	<p>2220-03 3530-03 4640-03 6555-03 8770-03</p>	<p>C1 or C2</p> <p>↓</p> <p>C1: Position of solder pads C2: Position of solder pads</p>	
---	--	---	--

LIST OF AVAILABLE PRODUCT TYPES

SPS-2220-03	SPS-3530-03-C1 SPS-3530-03-C2	SPS-4640-03-C1 SPS-4640-03-C2	SPS-6555-03-C1 SPS-6555-03-C2	SPS-8770-03-C1 SPS-8770-03-C2
-------------	----------------------------------	----------------------------------	----------------------------------	----------------------------------

PACKAGING

The SPS-2220-03/3530-03/4640-03/6555-03/8770-03 are packed in trays (245 L x 245 W) and sold in boxes with dimensions of 250 L x 250 W x 125 H.

Number	SPS-2220-03	SPS-3530-03	SPS-4640-03	SPS-6555-03	SPS-8770-03
per tray	81	25	16	9	6
per box	(81x70) 5670	(25x40) 1000	(16x40) 640	(9x40) 360	(6x40) 240

Dimensions of the tray and position of the SPS-speakers 2022-03/3035-03/4640-03/8770-03/SPS-27-01 are illustrated below:

SPS-2220-03	A=1.5 mm B=26 mm C=26 mm
SPS-3530-03	A=3 mm B=47.5 mm C=47.5 mm
SPS-4640-03	A=3 mm B=60 mm C=60 mm
SPS-6555-03	A=3 mm B=68.5 mm C=75.5 mm
SPS-8770-03	A=3 mm B=78 mm C=120 mm

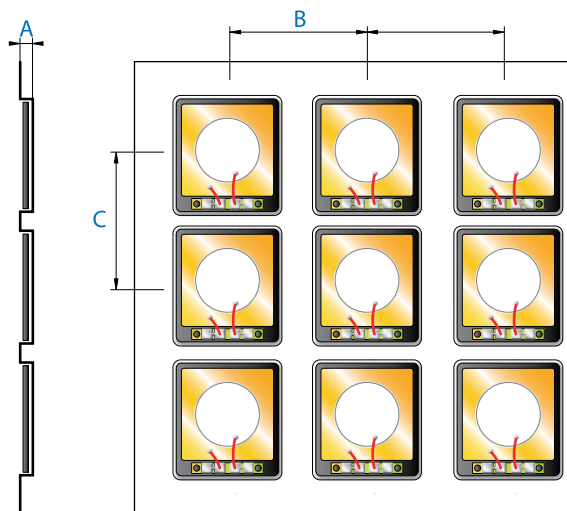

ACOUSTIC MOUNTING INSTRUCTIONS FOR SPS-SPEAKERS

- Fundamental mounting recommendations see page 110.
- The SPS speakers can be mounted in several different ways. The mounting methods, illustrated below, are recommended to mount all the SPS speaker models. Please keep in mind that not too much mechanical stress is placed on the frame of the piezoceramic speaker after mounting.

Mounted with glue or silicone

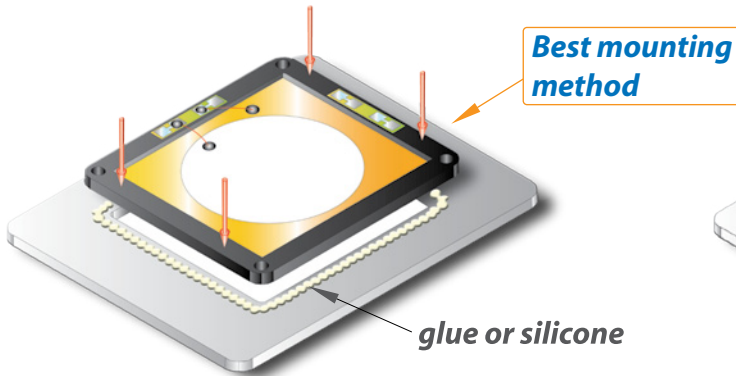

Mounted with slot groove



Mounted with screws

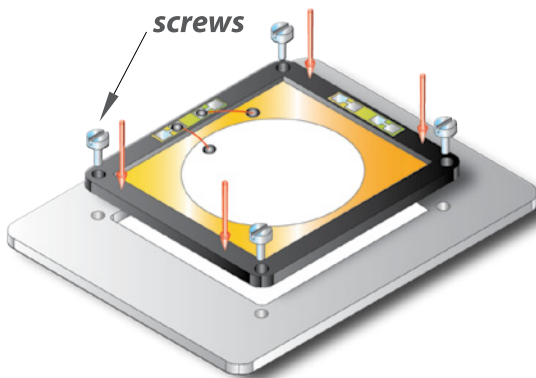

Plastic deformation method (Ultrasonic)

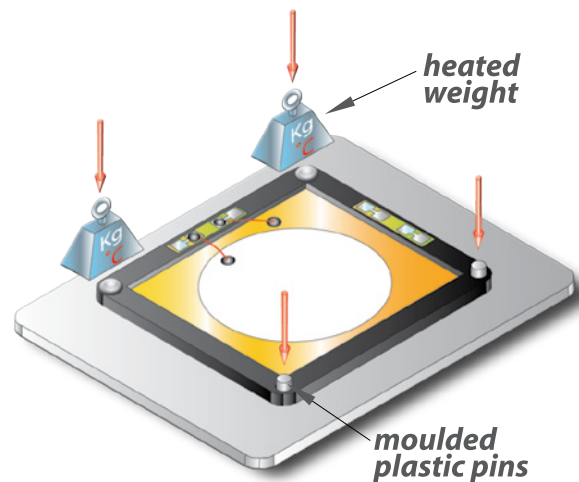

Other methods...

Speaker cloth fabric

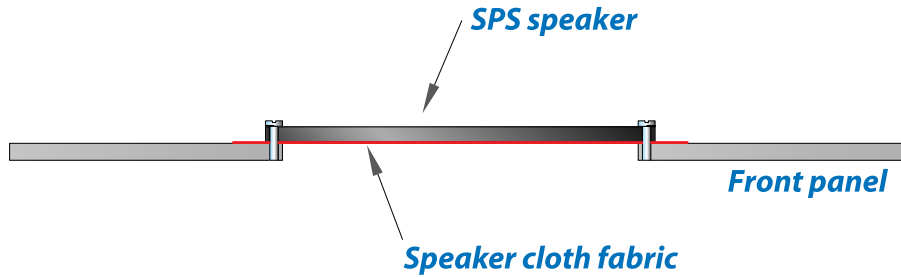

Front holes

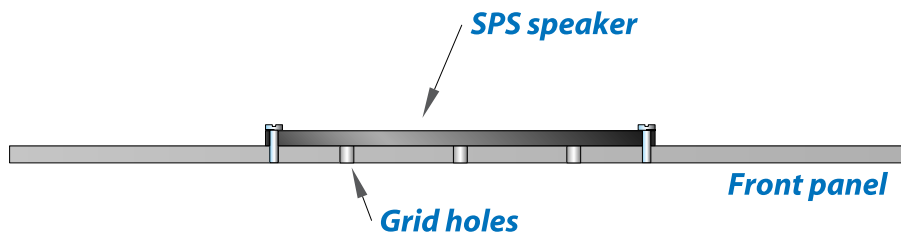

Front holes of

- 1 mm Ø for model SPS-2220-03
- 2 mm Ø for model SPS-3530-03
- 2 mm Ø for model SPS-4640-03
- 2 mm Ø for model SPS-8770-03

Distance front holes

- d=3 mm for model SPS-2220-03
- d=5 mm for model SPS-3530-03
- d=5 mm for model SPS-4640-03
- d=10 mm for model SPS-S8770-03

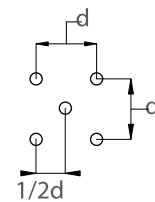

*Other designs of the hole pattern (grids) are also suitable. (SPS-2220-03, SPS-3530-03)

grid examples

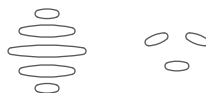

FUNDAMENTAL ACOUSTIC MOUNTING RECOMMENDATIONS

Important note:

Piezoceramic speakers produce sound by the forward and backward movement of a flat membrane. During this movement the membrane creates an air pressure wave in front and at the backside of the membrane. A forward movement will create a slight overpressure at the frontside and a slight underpressure at the backside and vice versa. It is therefore important that the front and backside are acoustically isolated from each other to avoid air pressure cancellation and consequently a serious reduction of the sound output.

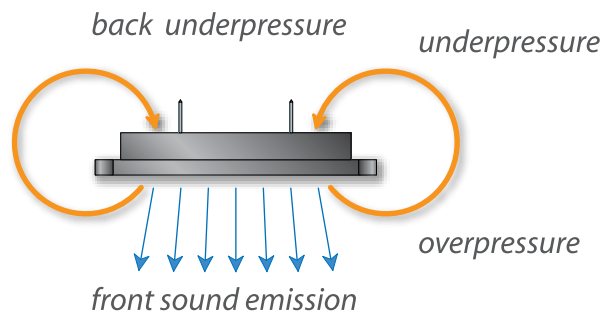

When a speaker is mounted in a panel or in the wall of a housing, the front side is acoustically isolated from the backside.

