

TRDT with TV-8 Approval

### MAIN FEATURES

- Switching capacity available by 12A,15A in spite of small size design for high density P.C. board mounting technique.
- Selection of plastic material for high temperature and better chemical solution performance.
- Sealed types available.
- Simple relay magnetic circuit to meet low cost of mass production.
- UL、CSA and TUV recognized.

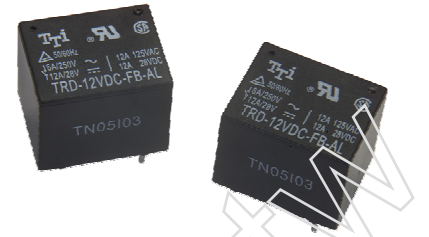

### APPLICATIONS

- TRD : • Domestic appliance, office machine, audio, equipment, automobile, etc.
- TRDT: • Remote control TV receiver, monitor display, audio equipment high rushing current use application.

### ORDERING INFORMATION

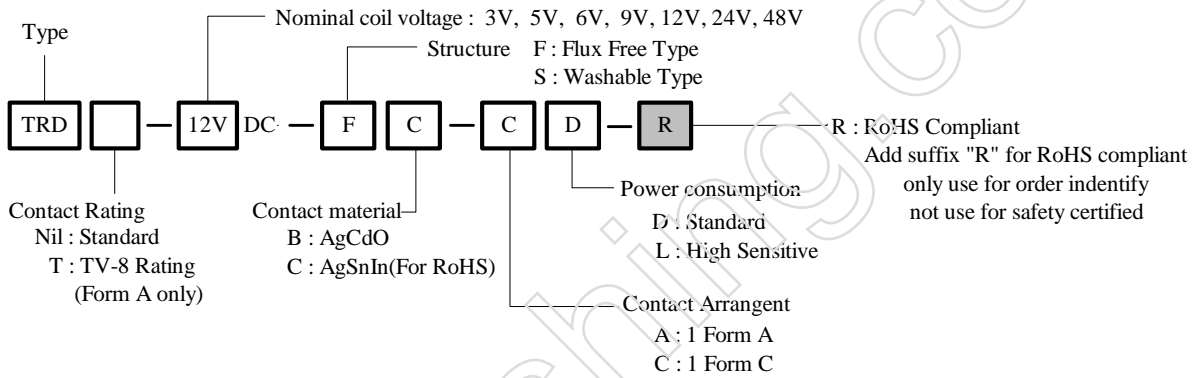

### DIMENSION (unit:mm)

### DRILLING (unit:mm)

### WIRING DIAGRAM

#### TRD Form A AND TRDT (TV-8) TYPE

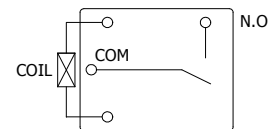
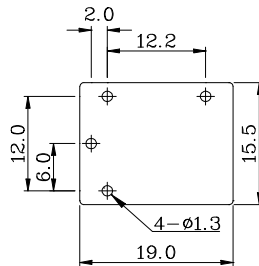
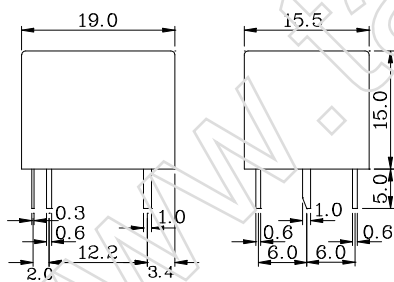

#### TRD Form C TYPE

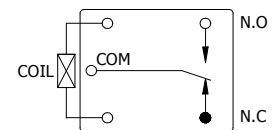
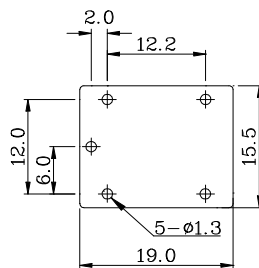
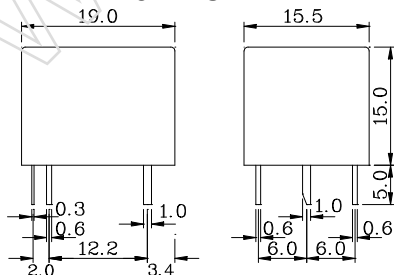

## COIL DATA CHART (AT20°C)

Coil Sensitivity	Nominal Voltage (VDC)	Nominal Current (mA)	Coil Resistance ( $\Omega$ ) $\pm 10\%$	Power Consumption (W)	Pull-In Voltage (VDC)	Drop-Out Voltage (VDC)	Max-Allowable Voltage (VDC)
TRD (High Sensitivity)	3	120	25	abt. 0.36W	75% Max.	5% Min.	120%
	5	71.4	70				
	6	60	100				
	9	40	225				
	12	30	400				
	24	15	1600				
TRD (Standard)	3	150	20	abt. 0.45W	75% Max.	5% Min.	110%
	5	89.3	55				
	6	75	80				
	9	50	180				
	12	37.5	320				
	24	18.7	1280				
	48	10	4500	abt. 0.50W			

## CONTACT RATING

Item	Type	TRD		TRDT (Form A)
		12A	15A	
Contact Capacity		12A 28VDC (UL)	12A 28VDC (UL)	125VAC TV-8
Resistive Load ( $\cos\Phi=1$ )		12A 120VAC	15A 125VAC	(Incandescent Lamp 8A)
		12A 28VDC(TUV)	15A 28VDC(TUV)	10A 250VAC
		6A 250VAC	10A 250VAC	15A 28VDC
Rated Carrying Current		12A	15A	15A
Max. Allowable Voltage		250VAC/110VDC	250VAC/110VDC	250VAC 110VDC
Max. Allowable Current		12A	15A	15A
Max. Allowable Power		1440VAC, 336W	1875VA, 420W	1875VA, 420W
Referenced Min. Applicable Load		5VDC, 10mA	5VDC, 10mA	5VDC, 10mA
Contact Material		Ag Alloy		

## PERFORMANCE (at initial value)

Item	Type	TRD
Contact Resistance		100m $\Omega$ Max.
Operation Time		10msec Max.
Release Time		5msec Max.
Dielectric Strength	Between coil & contact	1500VAC 50/60HZ (1 minute)
	Between contacts	750VAC 50/60HZ (1 minute)
Surge Resistiveness		3000V (between coil & contact 1x40u sec)
Insulation Resistance		100 M $\Omega$ Min. (500VDC)
Max. ON/OFF Switching	Mechanically	300 operation/min
	Electrically	30 operation/min
Operating Ambient Temperature		-30°C to +80°C (No water condensation and no water drop)
Operating Humidity		45 to 85% RH
Coil Temperature Rise		35 deg. Max.
Vibration	Endurance	10 to 55Hz Double Amplitude 1.5mm
	Error Operation	10 to 55Hz Double Amplitude 1.5mm
Shock	Endurance	100G Min.
	Error Operation	10G Min.
Life Expectancy	Mechanically	10 <sup>7</sup> operations. Min. (no load)
	Electrically	10 <sup>5</sup> operations. Min. (at rated coil voltage)
Weight		abt. 10grs.
UL		E156521(TV-8)
CSA		LR 102317
TUV		R 50062544

This datasheet for reference and subject to change without notice. Please double check final specification with Tai-Shing.

## REFERENCE DATA

Coil Temperature Rise

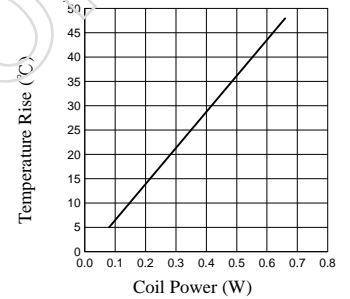

Operate Time

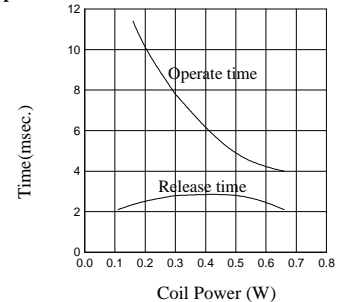

Life Expectancy

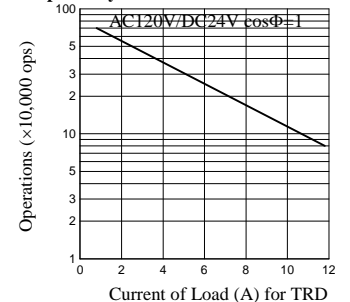

Life Expectancy

