

MAIN FEATURES

- Miniature heavy-duty relays
- Single-Pole, 10 Amp PC Board
- SPST and SPDT configurations
- 5KV dielectric coil to contacts
- Sealed & Unsealed types available
- UL • cUL and TUV recognized.

APPLICATIONS

- Microwave Ovens, Facsimiles, Refrigerators Air Conditioners, Stereo Equipment, Copier, TV Set, Vending Machines, Temperature Controllers, etc.

ORDERING INFORMATION

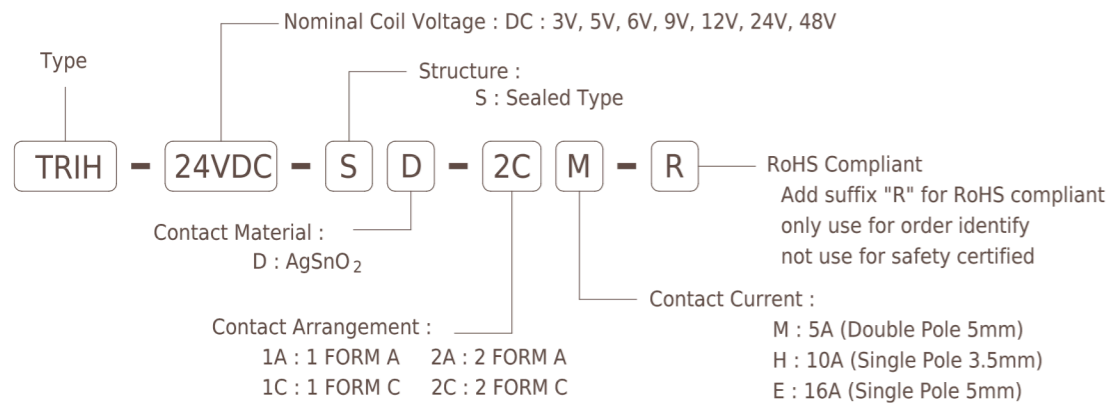

COIL DATA CHART(at 20°C)

Coil Sensitivity	Nominal Voltage (VDC)	Nominal Current (mA ±10%)	Coil Resistance (Ω ±10%)	Power Consumption (mW)	Pick-Up Voltage VDC(Max.)	Drop-out Voltage VDC(Min.)	allowable Voltage VDC (Max.)
TRIH (DC TYPE)	3	176	17	Approx. 530	80% Max.	10% Min. of nominal voltage	110% of nominal voltage
	5	106	47				
	6	88.2	68				
	9	56.2	160				
	12	43.6	275				
	24	21.8	1100±15%				
	48	11.5	4170±15%				

CONTACT RATING

Item	TRIH -E		TRIH -H		TRIH -M	
	E-Type		H-Type		M-Type	
Resistive load (cosΦ=1)	UL		16A 250VAC 16A 24VDC 1HP 240VAC TV-8 125VAC(*)	10A 250VAC 10A 30VDC 1/3HP 250VAC TV-5 125VAC	10A 250VAC 10A 30VDC TV-3 125VAC	
	TUV		16A 250VAC 16A 30VDC	10A 250VAC 10A 30VDC	5A 250VAC 5A 30VDC	
Carrying current	16A		10A		5A	
Max. switching voltage	277VAC, 30VDC					
Max. switching current	16A		10A		5A	
Max. switching power	4000VA 300W	2000VA 192W	2500VA 300W	1875VA 150W	1250VA 150W	500VA 90W
Min. permissible load	DC 5V 100mA			DC 5V 10mA		
Contact material	Silver Alloy					

* TRIH E-Type Form A(N.O.) Only.

DIMENSION(unit:mm)

M Type

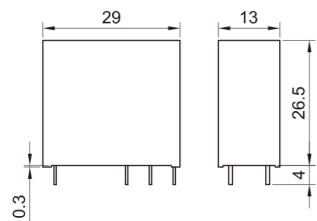

H Type

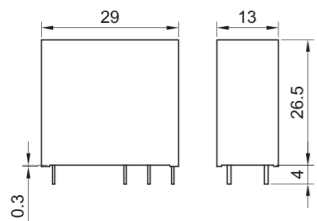

E Type

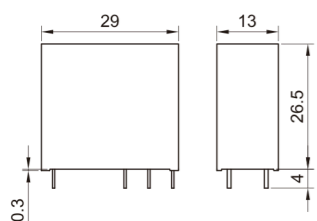

DRILLING(unit:mm)

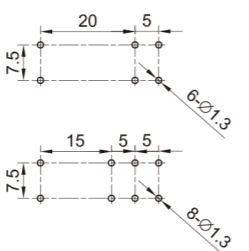
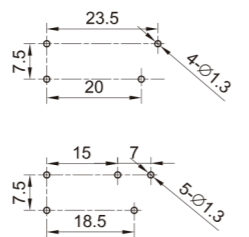
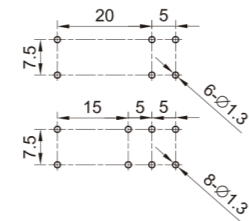

WIRING DIAGRAM

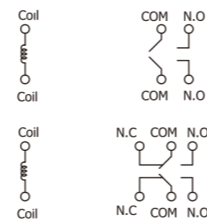

(De-energized Position)

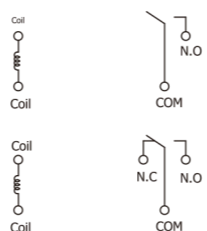

(De-energized Position)

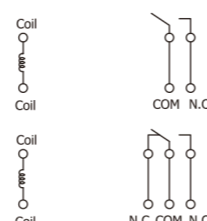

(De-energized Position)

PERFORMANCE(at initial value)

Item	TRIH
Contact Resistance	50mΩ Max.
Operation time	15msec Max. (at nominal voltage)
Release time	10msec Max. (at nominal voltage)
Dielectric strength	Between coil & contacts: 5000VAC. for 1minute Between open contacts: 3000VAC. for 1minute Between contact sets: 1000VAC. for 1minute
Insulation Resistance	100MΩ Min. (at 500VDC)
Operating frequency	20 ops/minute
Ambient temperature	
Storage	-40°C to +70°C
Operating	-40°C to +70°C
Humidity	35% to 85% RH
Vibration resistance	10 to 55 Hz, 1.5mm double amplitude
Shock resistance	
Functional :	98m/s ²
Destructive :	980m/s ²
Life expectancy	
Mechanical :	1 x 10 ⁷ operations
Electrical :	1 x 10 ⁵ operations (at rated load)
Weight	abt. 18g.
UL & cUL	E156406