

TRJ

MAIN FEATURES

- 5A、10A switching capabilities
- SPST-NO and SPDT configuration
- Subminiature, standard PC layout
- Sealed & Unsealed types available
- UL & cUL recognized.

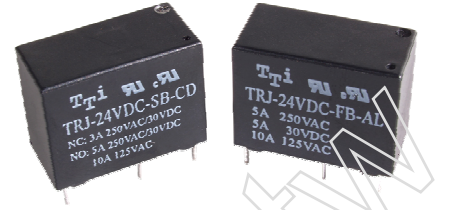

APPLICATIONS

- House-hold appliance, office machine, etc.

ORDERING INFORMATION

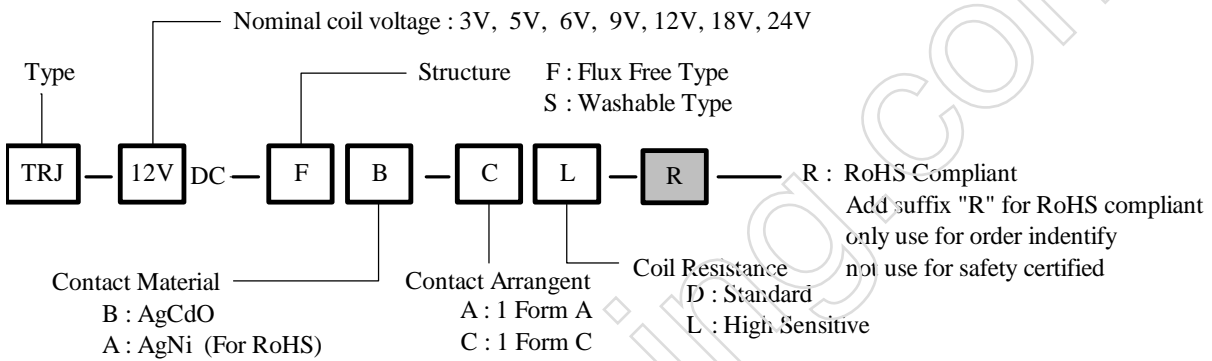

DIMENSION (unit:mm)

DRILLING (unit:mm)

WIRING DIAGRAM

1 Form A

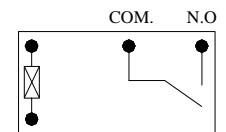
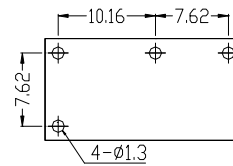
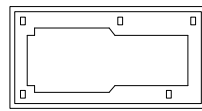
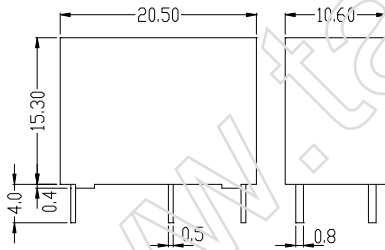

1 Form C

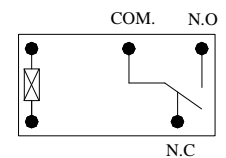
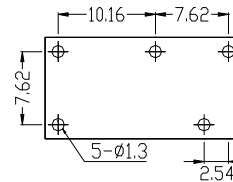
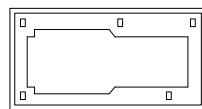
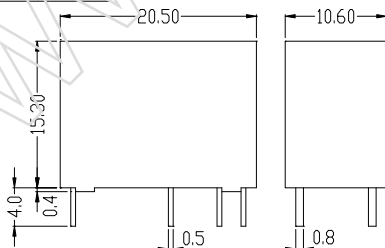

COIL DATA CHART (AT20°C)

Coil Sensitivity	Nominal Voltage (VDC)	Nominal Current (mA)	Coil Resistance (Ω) $\pm 10\%$	Power Consumption (W)	Pull-In Voltage (VDC)	Drop-Out Voltage (VDC)	Max-Allowable Voltage (VDC)
TRJ-L (High Sensitivity)	3	67	45	abt. 0.2W	75% Max.	5% Min.	110% Max.
	5	40	125				
	6	33.3	180				
	9	22.5	400				
	12	16.7	720				
	18	11.25	1600				
TRJ-D (Standard)	3	150	20	abt. 0.45W	75% Max.	5% Min.	110% Max.
	5	91	55				
	6	75	80				
	9	50	180				
	12	37.5	320				
	18	25	720				
	24	18.75	1280				

CONTACT RATING

Item	Type	TRJ		
		1 Form A	1 Form C	
			N/O	N/C
Contact Capacity		5A 30VDC	5A 30VDC	3A 30VDC
Resistive Load ($\cos\Phi=1$)		5A 250VAC 10A 125VAC	5A 250VAC 10A 125VAC	3A 30VDC 3A 250VAC
Rated Carrying Current		10A	10A	3A
Max. Allowable Voltage		30VDC 277VAC		
Max. Allowable Current		10A	10A	3A
Max. Allowable Power Force		150W 1250VA 90W 750VA		
Contact Material		Ag Alloy		

PERFORMANCE (at initial value)

Item	Type	TRJ
Contact Resistance		100m Ω Max (measured at 1A 24VDC).
Operation Time		3msec Max.
Release Time		5msec Max.
Dielectric Strength		
Between coil & contact		4000VAC, 1min
Between contacts		1000VAC, 1min
Insulation Resistance		1000 M Ω Min. (500VDC)
Operating Ambient Temperature		-40°C to +70°C
Operating Humidity		35% ~ 95%
Vibration Resistance		10 to 55Hz Double Amplitude 1.6mm
Shock Resistance		
Function		100 m/s ²
Destructive		1000 m/s ²
Life Expectancy		
Mechanically		1 × 10 ⁷ ops. Min. (no load)
Electrically		1 × 10 ⁵ ops. Min. (at rated coil voltage)
Weight		Abt. 7grs
UL & cUL		E156406

REFERENCE DATA

Life Expectancy

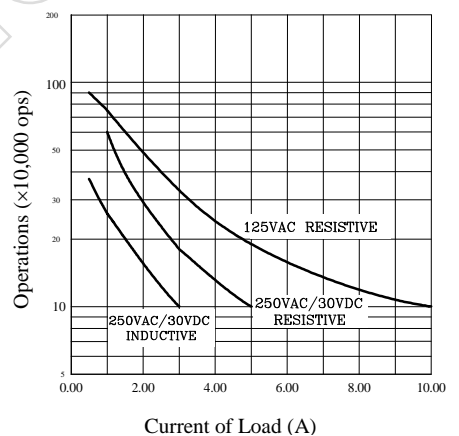

Coil Temperature Rise

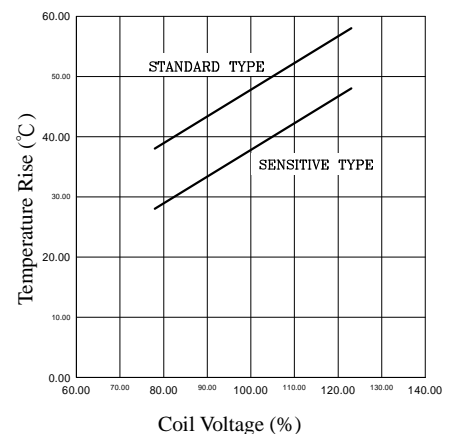

This datasheet for reference and subject to change without notice. Please double check final specification with Tai-Shing.