

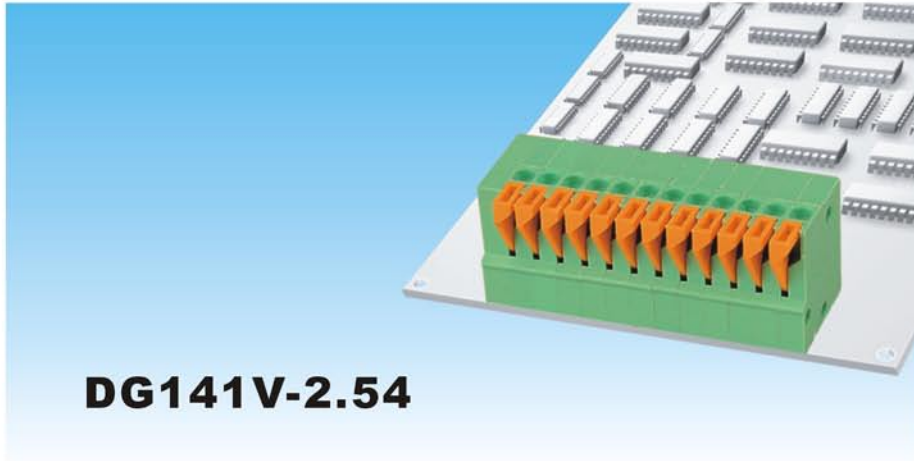

DEGSON ELECTRONICS CO., LTD.

Product Specification



DG141V-2.54

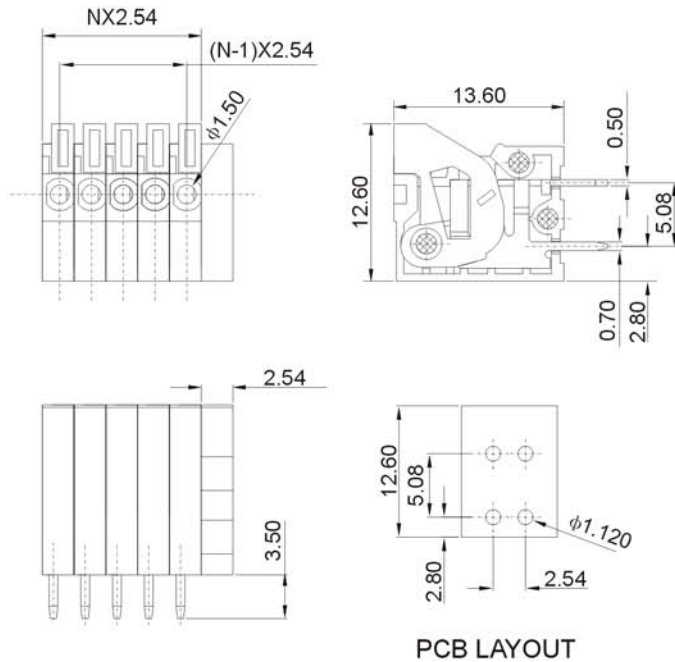

Material	
Wire guard:	Stainless steel
Pin header:	Brass, Tin plated
Housing :	PA66, UL94V-0
Electrical	
Rated voltage :	150V
Rated current :	2A
Contact resistance :	20m Ω
Insulation resistance :	5000M Ω /DC1000V
Withstanding voltage:	AC2000V/1Min
Wire range :	26-20AWG 1.0mm ²
Mechanical	
Temp.Range :	-40°C~+105°C
Striplength :	11mm

HOW TO ORDER:

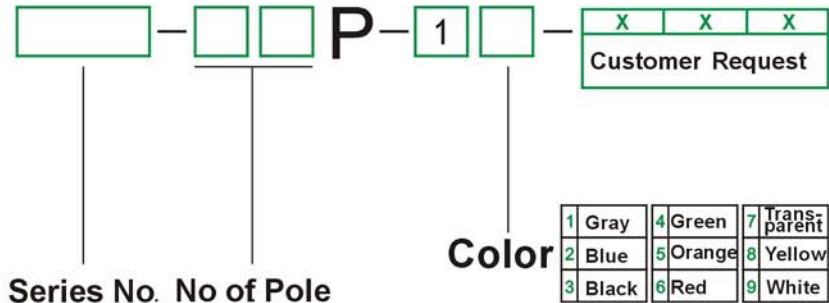

	DEGSON ELECTRONICS CO., LTD.
	NAME DG141V-2.54