



DEGSON ELECTRONICS CO., LTD.

Product Specification



DG306-5.0

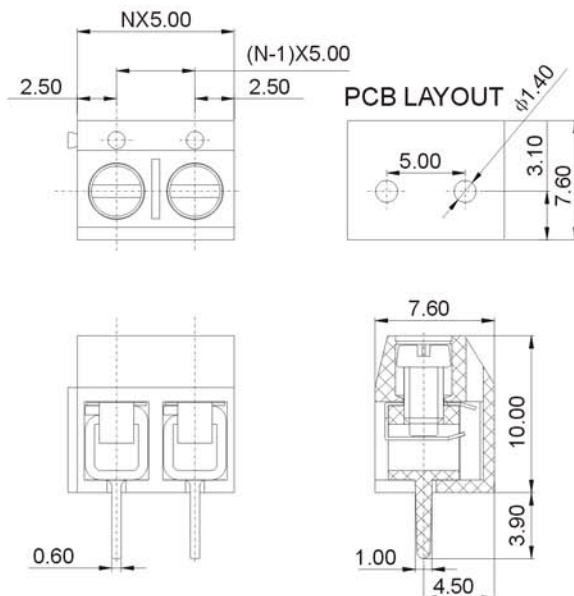

Material	
Screws :	M2.5 steel Zinc plated
Wire guard:	Stainless steel
Pin header:	Brass, Tin plated
Housing :	PBT, UL94V-0
Electrical	
Rated voltage :	300V
Rated current :	10A
Contact resistance :	20m Ω
Insulation resistance :	5000M Ω /DC 1000V
Withstanding voltage:	AC2000V/1Min
Wire range :	22-14AWG 2.5mm ²
Mechanical	
Temp. Range :	-30°C~+120°C
Torque :	0.4Nm(3.6lb.in)
Striplength :	4.5-5mm

HOW TO ORDER:

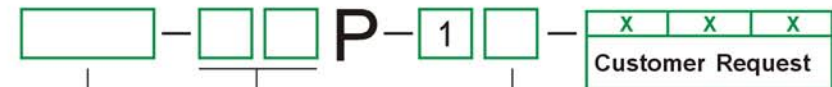

Series No. No of Pole

Color

1 Gray	4 Green	7 Trans- parent
2 Blue	5 Orange	8 Yellow
3 Black	6 Red	9 White

	DEGSON ELECTRONICS CO., LTD.
	NAME DG306-5.0