



ERD SERIES

10x10 SIZE SEALED CONSTRUCTION ROTARY TYPE

PIN OUT (3:3)		PIN OUT(1:4)	
			
ERD 1xxxx (Flat Type)	ERD 2xxxx (Shaft Type)	ERD 4xxxx (Flat Type)	ERD 5xxxx (Shaft Type)

■ FEATURES

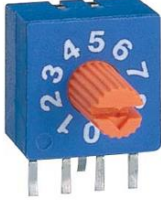
- Molded-in terminals and fully sealed construction.
- All plastics UL 94V-0 grade fire retardant.
- Reliable contact and long-term stability.
- Binary decimal (8 or 10 positions) and hexadecimal (16 positions), real and complementary codes available.
- Pin-out is compatible with most of current equivalents.
- Gold plated contact to ensure low contact resistance.
- RoHS Compliant

■ APPLICATIONS

- Address switching applications
- Data storage devices
- Computer and peripherals
- Instrumentation

■ SPECIFICATIONS

1.ELECTRICAL

● Contact rating	switching	25mA, 24VDC
	non-switching	100mA
● Contact resistance (initial)		100mΩ Max.
● Insulation resistance		1000MΩ Min. at 100VDC
● Dielectric strength		250VAC Min. for 60 seconds

2.MECHANICAL AND ENVIRONMENTAL

● Temperature rating	operating	-25°C to +70°C
	storage	-40°C to +85°C
● Operation force		500 gf-cm Max.



Switch

● Mechanical life	1000 steps
● Vibration	10Hz-55Hz-10Hz for 6 Hrs.
● Solderability (for through hole type)	After flux 230±5°C for 5±0.5 seconds, 95% coverage
● Resistance to soldering heat (for through hole type)	260±5°C for 5±1 seconds
● Reflow soldering heat for SMT type (reference only)	240°C for 20 seconds or less, peak temperature 260°C or less

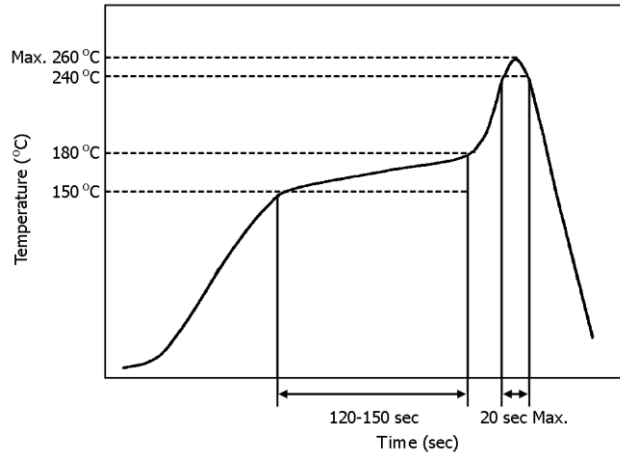

■ PART NUMBERING SYSTEM

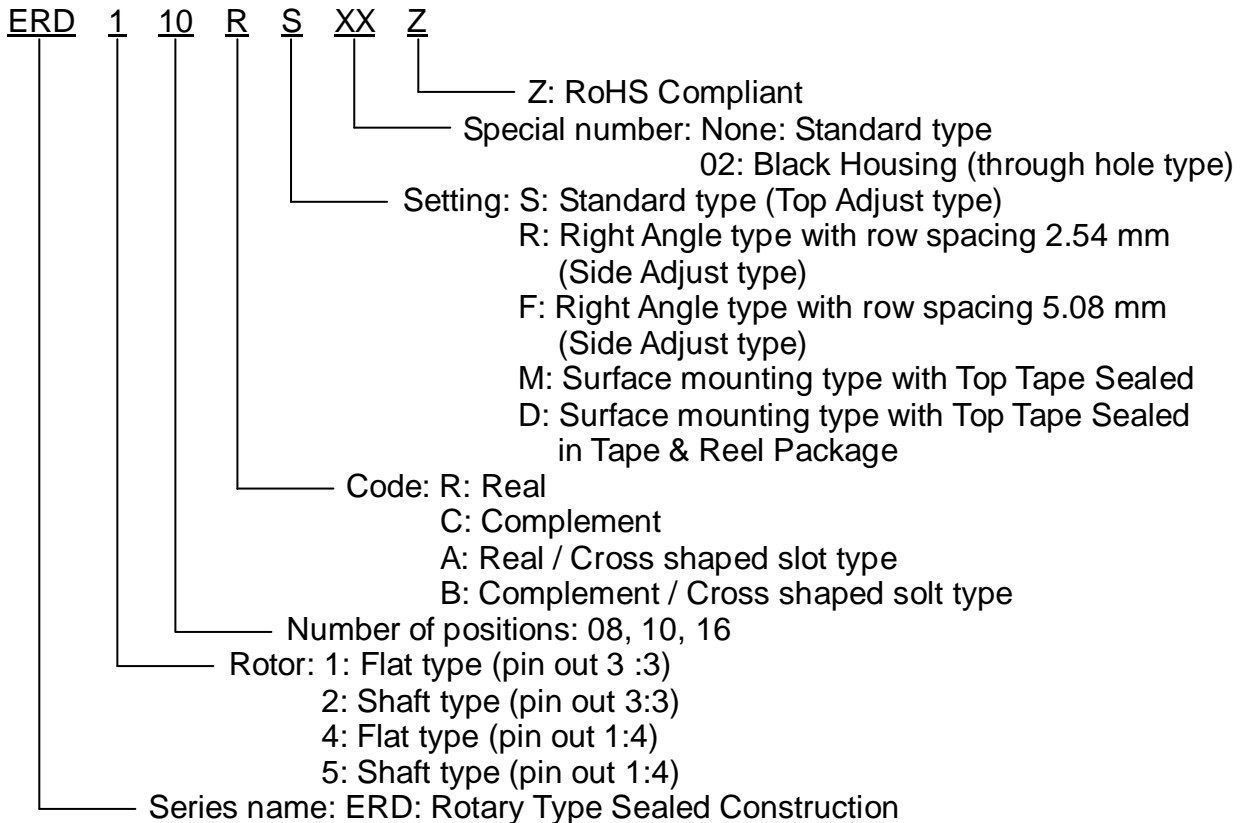

CODE

PIN NO.	POSITIONS															
	0	1	2	3	4	5	6	7	8	9	A	B	C	D	E	F
1	○	●	○	●	○	●	○	●	○	●	○	●	○	●	○	●
2	○	○	●	●	○	○	●	●	○	○	●	●	○	○	●	●
4	○	○	○	○	●	●	●	●	○	○	○	○	●	●	●	●
8	○	○	○	○	○	○	○	○	●	●	●	●	●	●	●	●

- ... Real Code
Rotor color:
White (3:3), Yellow (1:4)
- ... Complement Code
Rotor color:
Red (3:3), Orange (1:4)

CONSTRUCTION

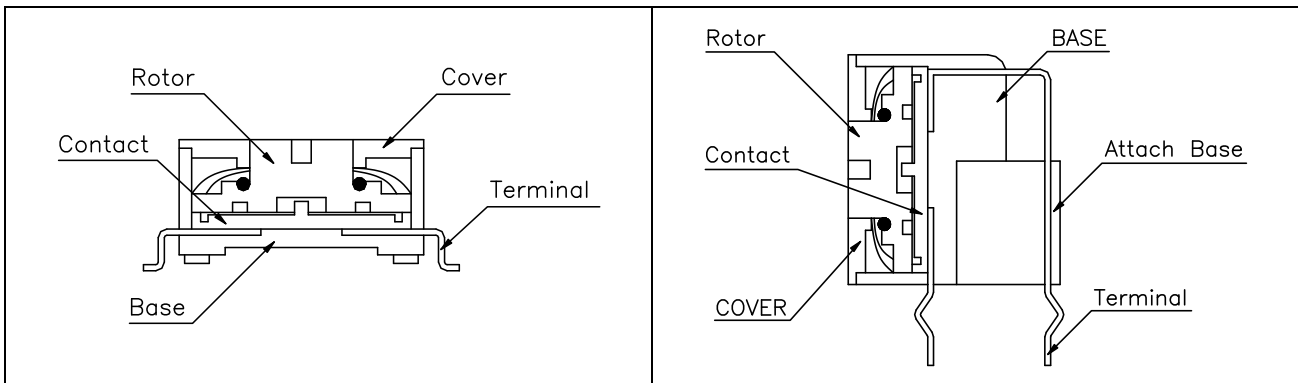

PACKING

1. Tape & Reel Packaging (Per EIA STANDARD)

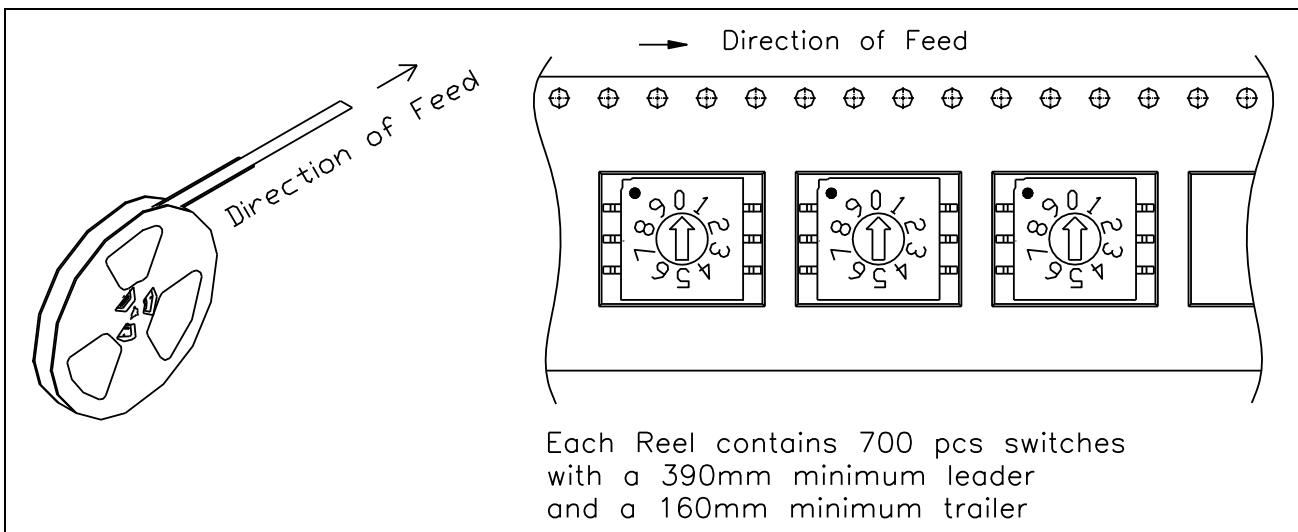

■ OPTIONS

1.Special marking available upon request

2.Shaft Cover

- 418-80100 (White 3:3)
- 418-80200 (Red 3:3)
- 418-80300 (Yellow 1:4)
- 418-80400 (Orange 1:4)

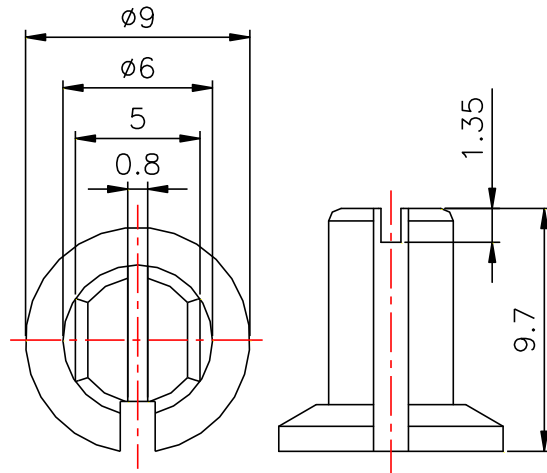

3.Shaft (For Cross Slot Type Only)

- 418-90010 (White 3:3)
- 418-90020 (Red 3:3)

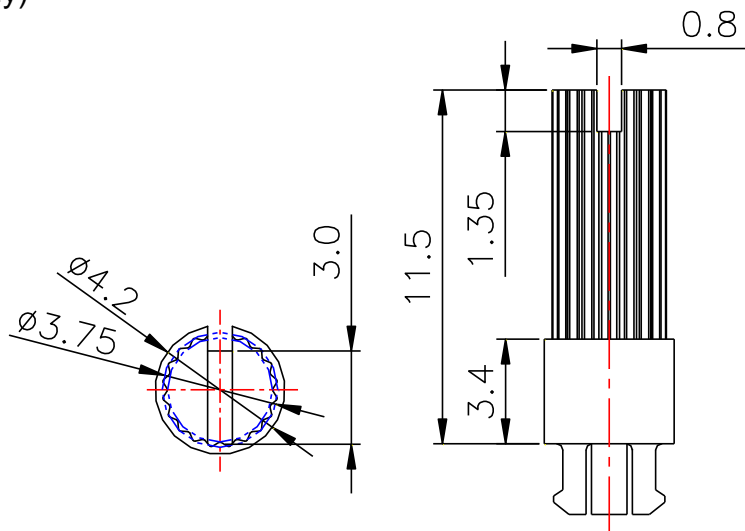

■ INTRODUCTION to ECE ROTARY DIP SWITCH

SIZE	POSITIONS	CODE	PIN OUT	ROTOR	TYPE	PART NUMBER
10x10	8,10,16	REAL, COMPLEMENT	3:3	FLAT, SHAFT	STANDARD	ERD1xxxS, ERD2xxxS
					RIGHT ANGLE	ERD1xxxR/F, ERD2xxR/F
				FLAT	SMT	ERD1xxxM
					SMT IN T&R	ERD1xxxD
			1:4	FLAT, SHAFT	STANDARD	ERD4xxxS, ERD5xxxS
					RIGHT ANGLE	ERD4xxxR/F, ERD5xxxR/F
				FLAT	SMT	ERD4xxxM
					SMT IN T&R	ERD4xxxD

■ DIMENSIONS AND CIRCUITRY UNIT:mm(inch) PIN OUT 3:3

ERD1XXXS Flat Type

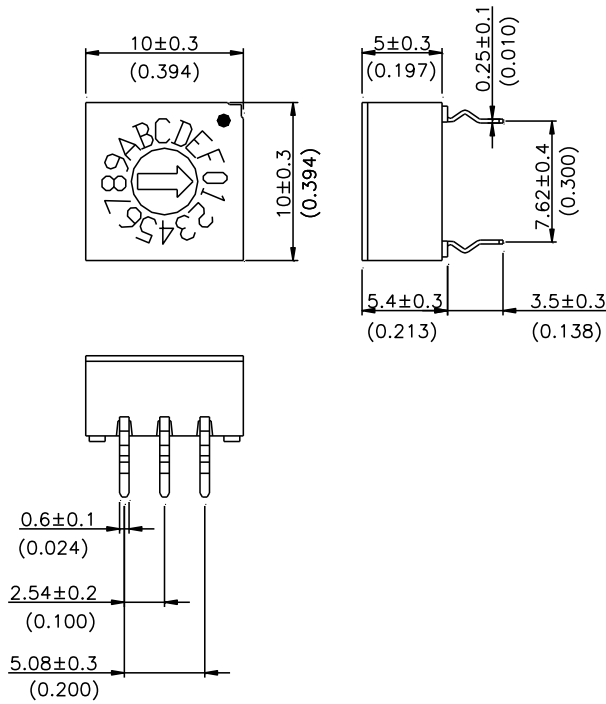

P.C.B. LAYOUT (TOP VIEW)

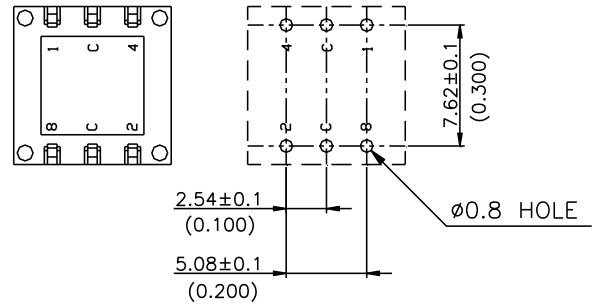

ERD2XXXS Shaft Type

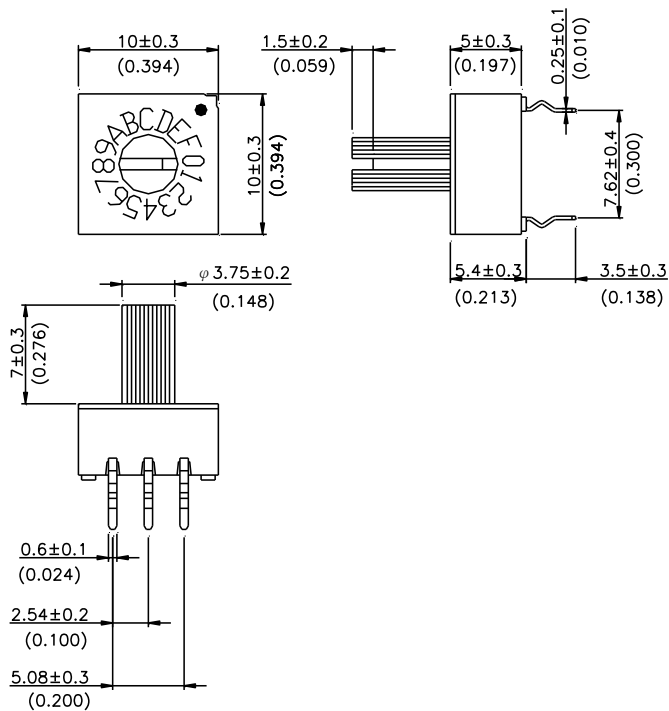

P.C.B. LAYOUT (TOP VIEW)

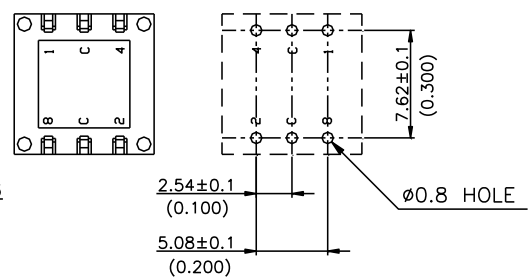

ERD1XXXR Flat Type

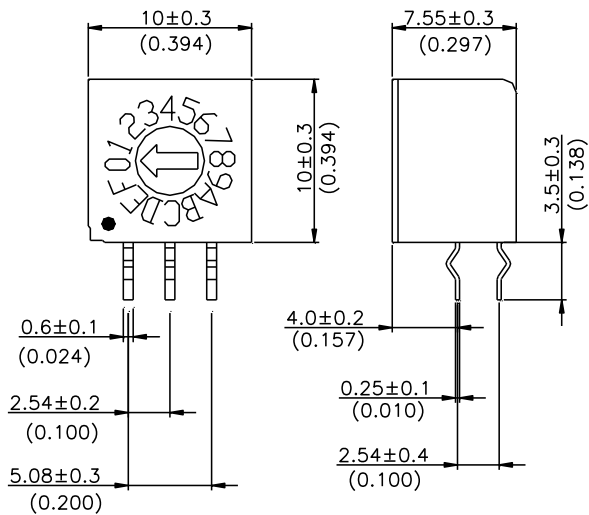

P.C.B. LAYOUT (TOP VIEW)

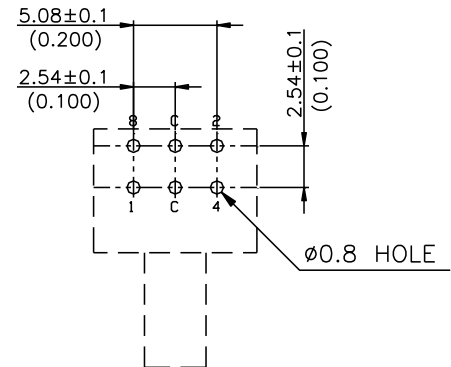

ERD2XXXR Shaft Type

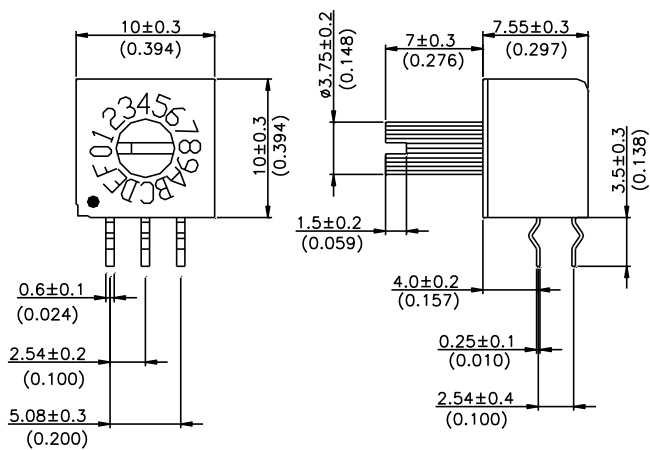

P.C.B. LAYOUT (TOP VIEW)

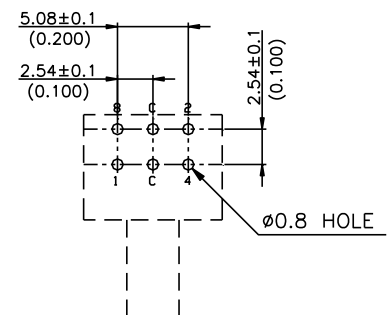

ERD1XXXF Flat Type

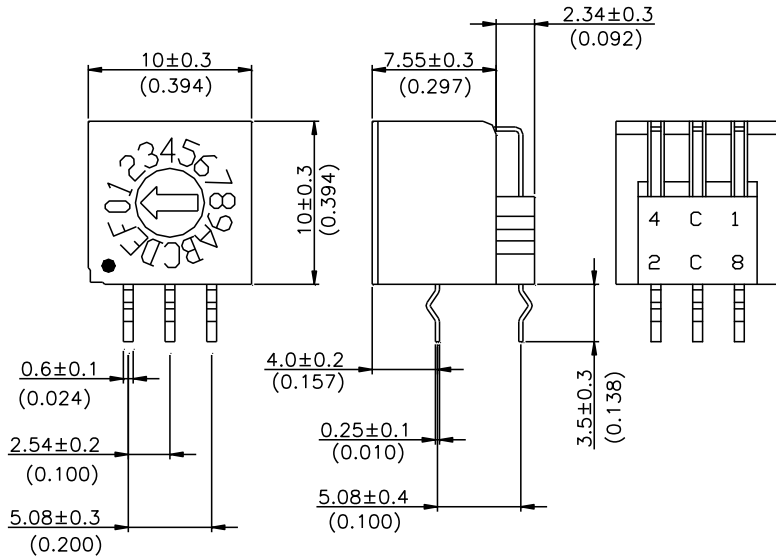

P.C.B. LAYOUT (TOP VIEW)

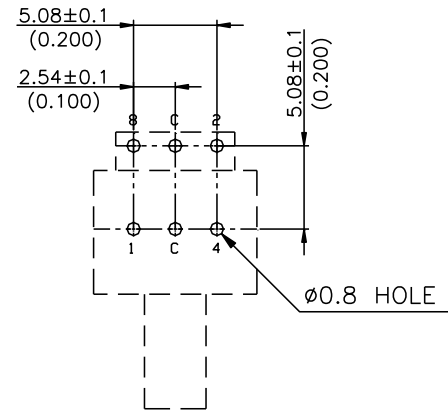

ERD2XXXF Shaft Type

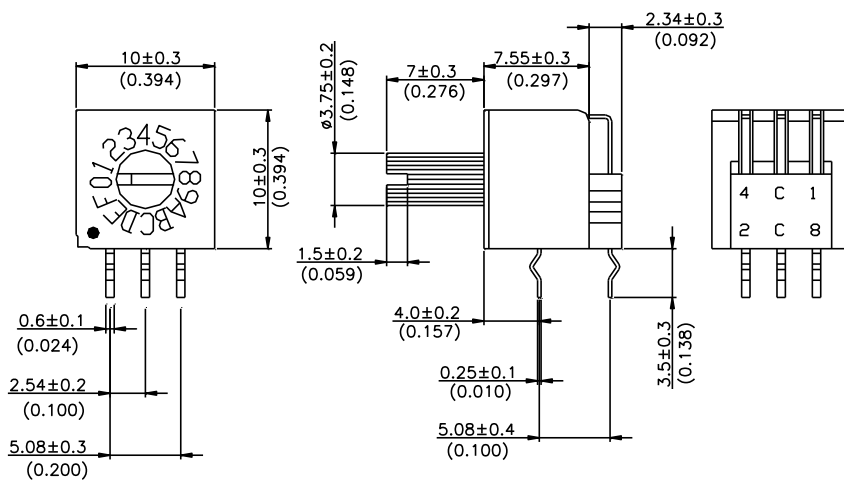

P.C.B. LAYOUT (TOP VIEW)

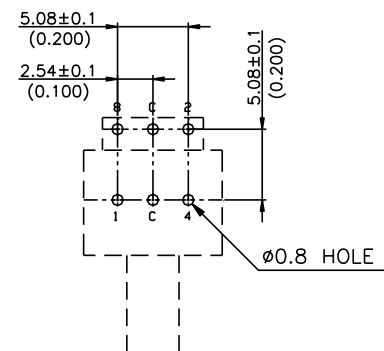

ERD1XXM Flat Type

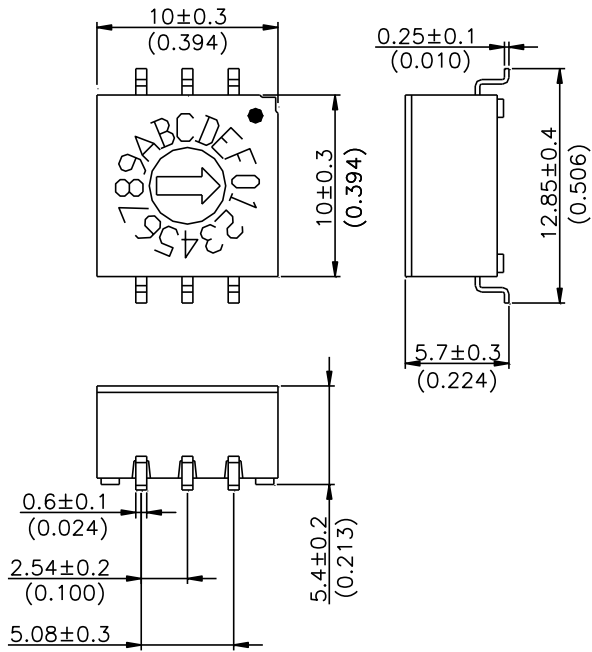

P.C.B. LAYOUT (TOP VIEW)

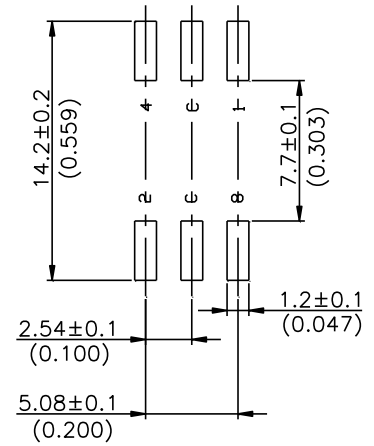

■ DIMENSIONS AND CIRCUITRY UNIT:mm(inch) PIN OUT 1:4

ERD4XXS Flat Type

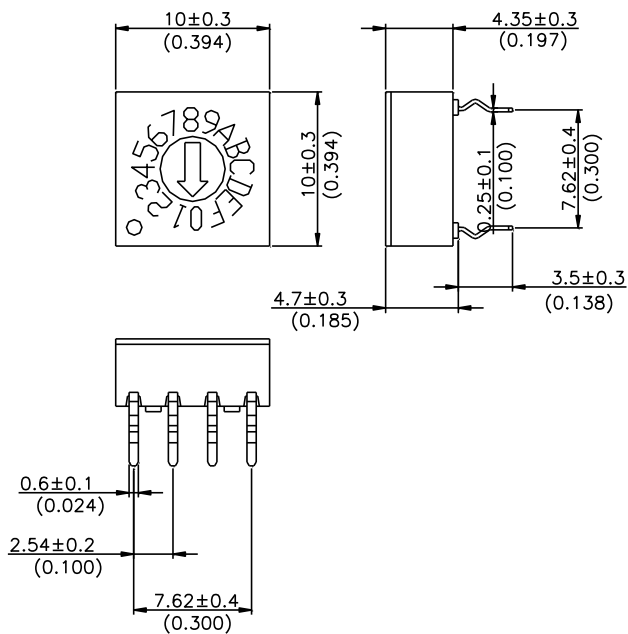

P.C.B. LAYOUT (TOP VIEW)

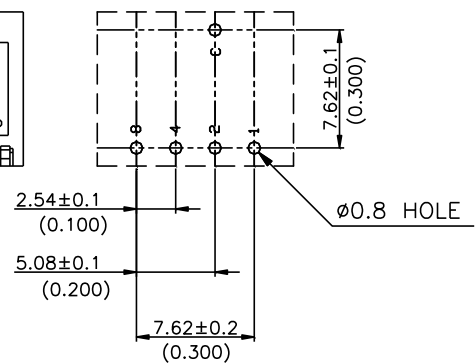

ERD5XXXS Shaft Type

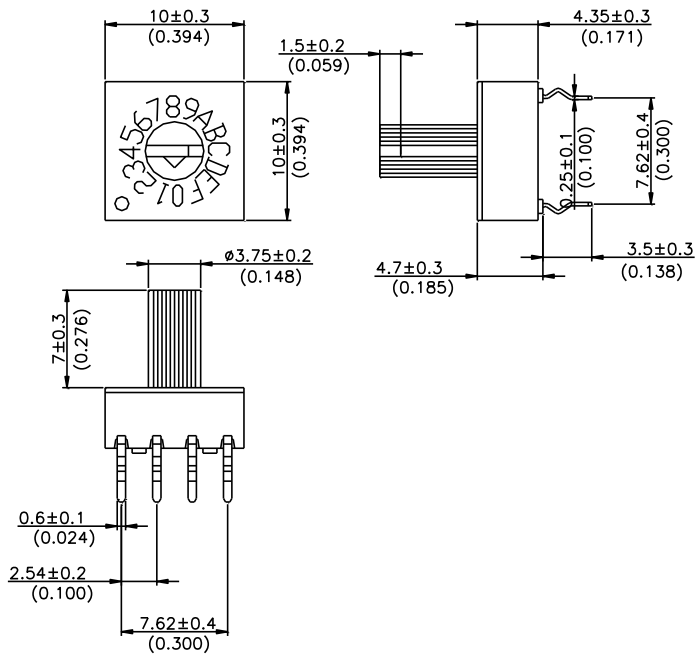

P.C.B. LAYOUT
(TOP VIEW)

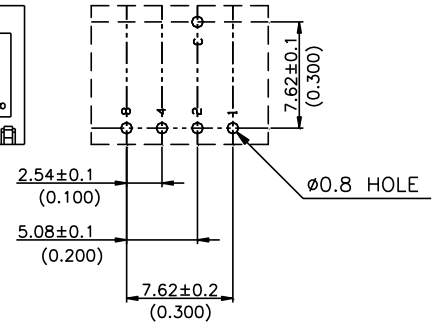

ERD4XXXR Flat Type

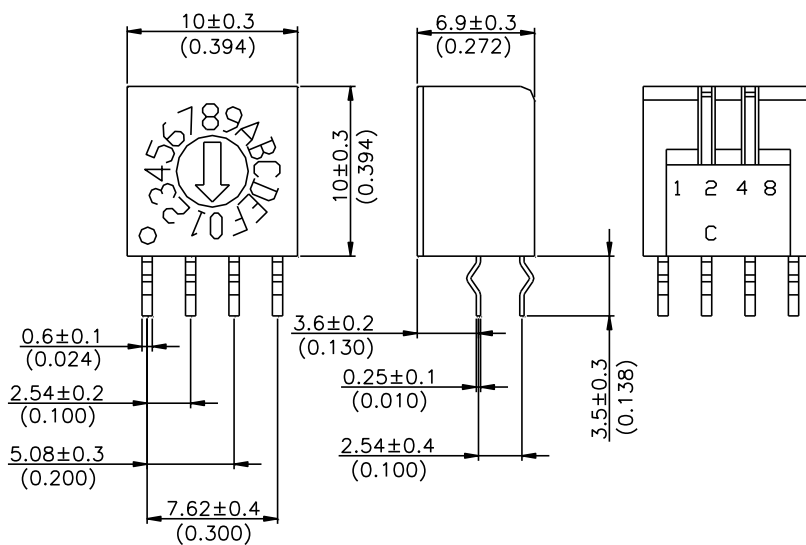

P.C.B. LAYOUT
(TOP VIEW)

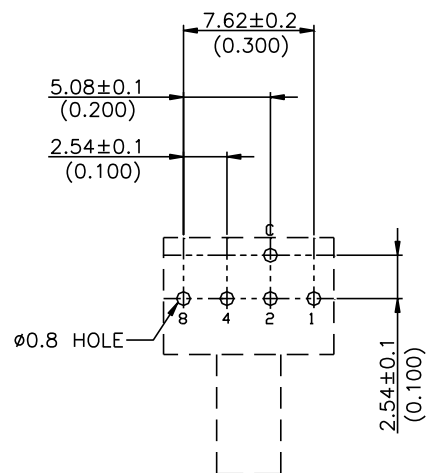

ERD5XXXR Shaft Type

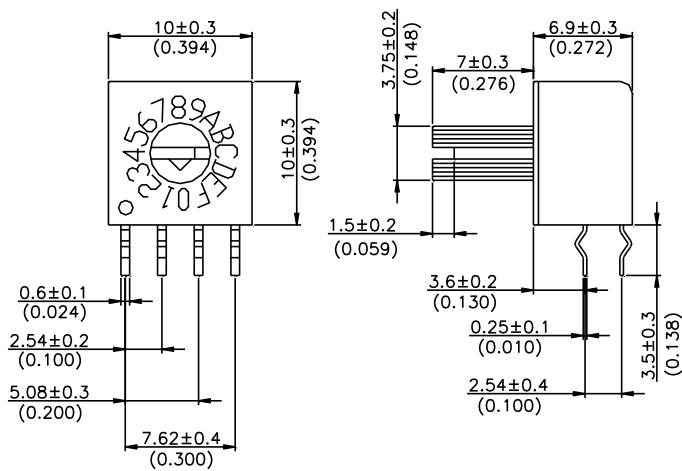

P.C.B. LAYOUT (TOP VIEW)

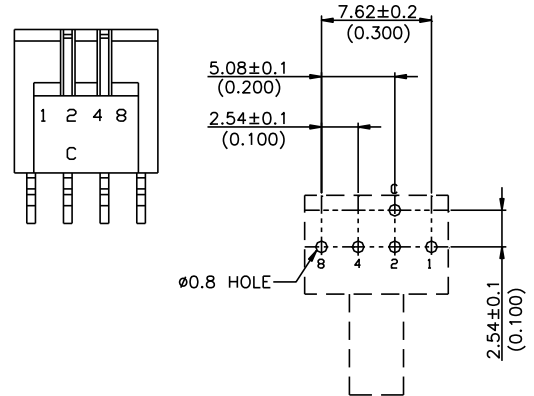

ERD4XXXF Flat Type

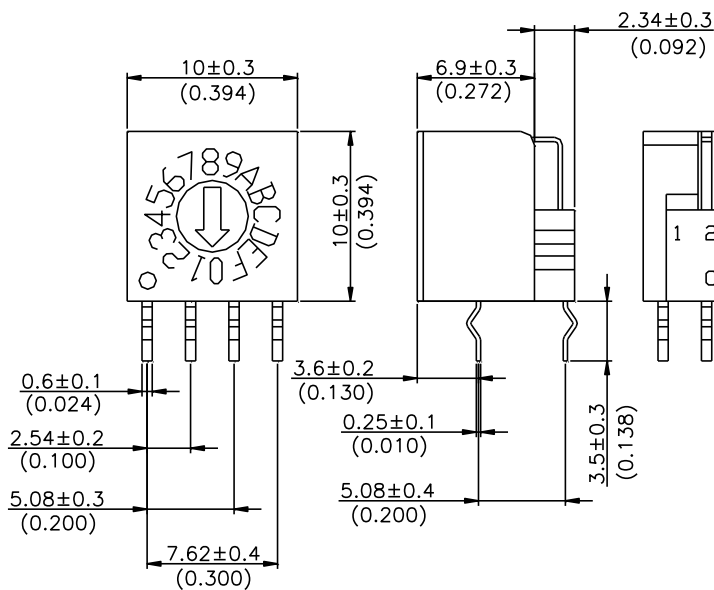

P.C.B. LAYOUT (TOP VIEW)

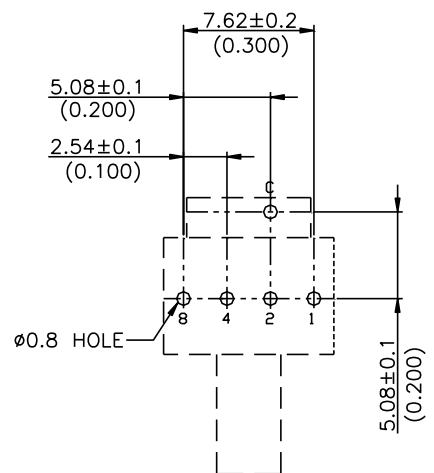

ERD5XXXF Shaft Type

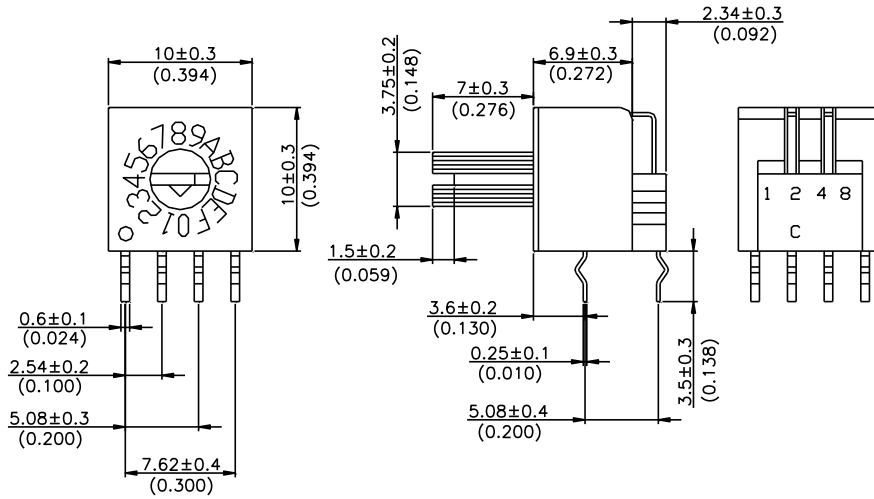

P.C.B. LAYOUT (TOP VIEW)

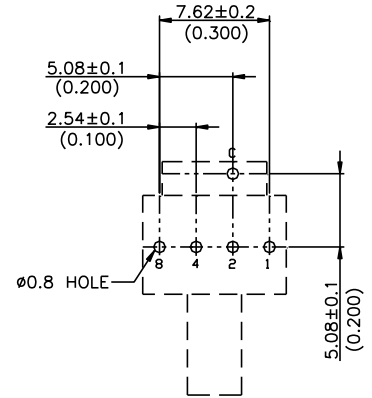

ERD4XXXM Flat Type

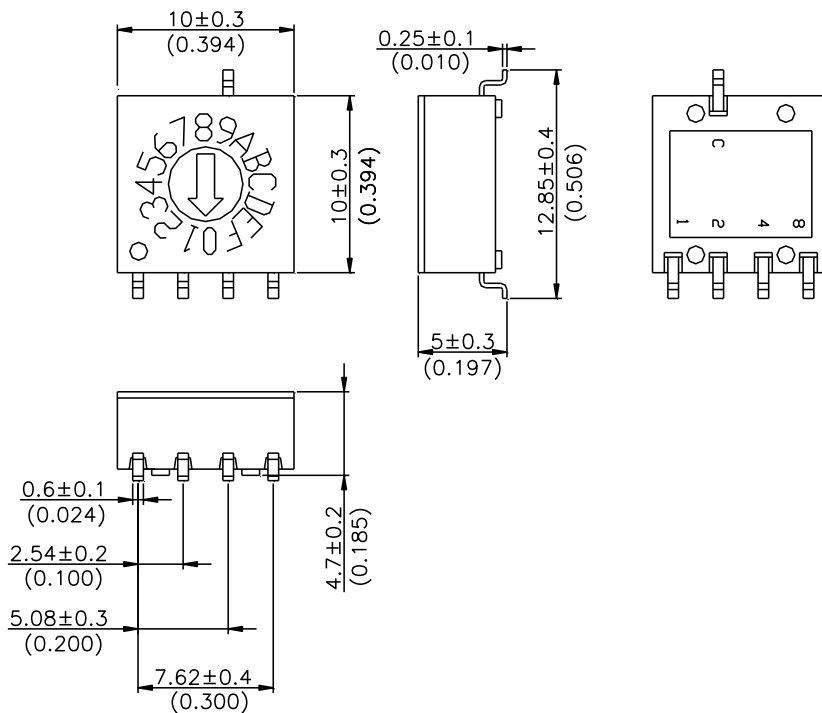

P.C.B. LAYOUT (TOP VIEW)

