

TPS76030, TPS76032, TPS76033, TPS76038, TPS76050 LOW-POWER 50-mA LOW-DROPOUT LINEAR REGULATORS

SLVS144D – JULY 1998 – REVISED MAY 2001

- 50-mA Low-Dropout Regulator
- Fixed Output Voltage Options: 5 V, 3.8 V, 3.3 V, 3.2 V, and 3 V
- Dropout Typically 120 mV at 50 mA
- Thermal Protection
- Less Than 1- μ A Quiescent Current in Shutdown
- -40°C to 125°C Operating Junction Temperature Range
- 5-Pin SOT-23 Package
- ESD Protection Verified to 1.5 kV Human Body Model (HBM) per MIL-STD-883C

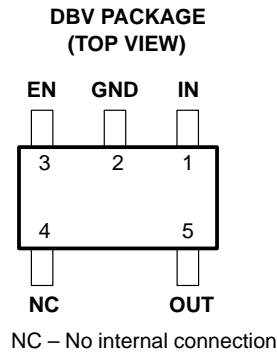

description

The TPS760xx is a 50 mA, low dropout (LDO) voltage regulator designed specifically for battery-powered applications. A proprietary BiCMOS fabrication process allows the TPS760xx to provide outstanding performance in all specifications critical to battery-powered operation.

The TPS760xx is available in a space-saving SOT-23 package and operates over a junction temperature range of -40°C to 125°C .

AVAILABLE OPTIONS

T_J	VOLTAGE	PACKAGE	PART NUMBER	SYMBOL
-40°C to 125°C	3 V	SOT-23	TPS76030DBVR	PAGI
	3.2 V		TPS76032DBVR	PAOI
	3.3 V		TPS76033DBVR	PAHI
	3.8 V		TPS76038DBVR	PAJI
	5 V		TPS76050DBVR	PANI

NOTE: The DBV package is available taped and reeled only.

functional block diagram

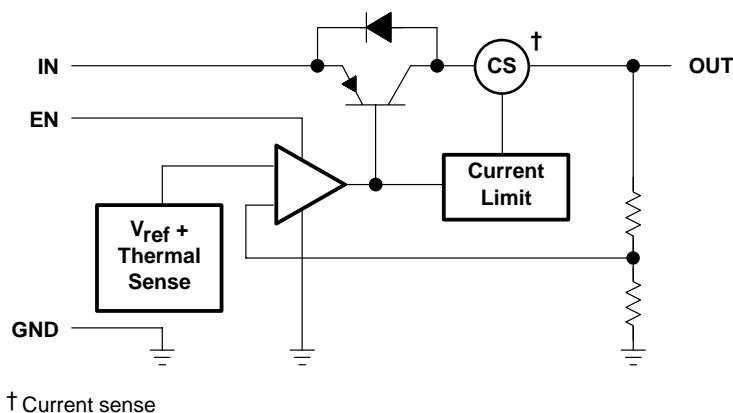

Please be aware that an important notice concerning availability, standard warranty, and use in critical applications of Texas Instruments semiconductor products and disclaimers thereto appears at the end of this data sheet.

PRODUCTION DATA information is current as of publication date. Products conform to specifications per the terms of Texas Instruments standard warranty. Production processing does not necessarily include testing of all parameters.

**TEXAS
INSTRUMENTS**

POST OFFICE BOX 655303 • DALLAS, TEXAS 75265

Copyright © 2001, Texas Instruments Incorporated

TPS76030, TPS76032, TPS76033, TPS76038, TPS76050

LOW-POWER 50-mA LOW-DROPOUT LINEAR REGULATORS

SLVS144D – JULY 1998 – REVISED MAY 2001

Terminal Functions

TERMINAL NAME	NO.	I/O	DESCRIPTION
EN	3	I	Enable input
GND	2		Ground
IN	1	I	Input voltage
NC	4		No connection
OUT	5	O	Regulated output voltage

absolute maximum ratings over operating free-air temperature range (unless otherwise noted)†

Input voltage range, V_I ‡	–0.3 V to 16 V
Voltage range at EN	–0.3 V to $V_I + 0.3$ V
Peak output current	internally limited
Continuous total dissipation	See Dissipation Rating Table
Operating junction temperature range, T_J	–40°C to 150°C
Storage temperature range, T_{stg}	–65°C to 150°C
ESD rating, HBM	1.5 kV

† Stresses beyond those listed under “absolute maximum ratings” may cause permanent damage to the device. These are stress ratings only, and functional operation of the device at these or any other conditions beyond those indicated under “recommended operating conditions” is not implied. Exposure to absolute-maximum-rated conditions for extended periods may affect device reliability.

‡ All voltages are with respect to device GND pin.

DISSIPATION RATING TABLE

BOARD	PACKAGE	$R_{\theta JC}$	$R_{\theta JA}$	DERATING FACTOR ABOVE $T_A = 25^\circ\text{C}$	$T_A \leq 25^\circ\text{C}$ POWER RATING	$T_A = 70^\circ\text{C}$ POWER RATING	$T_A = 85^\circ\text{C}$ POWER RATING
Low K§	DBV	65.8 °C/W	259 °C/W	3.9 mW/°C	386 mW	212 mW	154 mW
High K¶	DBV	65.8 °C/W	180 °C/W	5.6 mW/°C	555 mW	305 mW	222 mW

§ The JEDEC Low K (1s) board design used to derive this data was a 3 inch x 3 inch, two layer board with 2 ounce copper traces on top of the board.

¶ The JEDEC High K (2s2p) board design used to derive this data was a 3 inch x 3 inch, multilayer board with 1 ounce internal power and ground planes and 2 ounce copper traces on top and bottom of the board.

recommended operating conditions

		MIN	NOM	MAX	UNIT
Input voltage, V_I	TPS76030	3.2		16	V
	TPS76032	3.4		16	
	TPS76033	3.5		16	
	TPS76038	4		16	
	TPS76050	5.2		16	
Continuous output current, I_O		0		50	mA
Operating junction temperature, T_J		–40		125	°C



TPS76030, TPS76032, TPS76033, TPS76038, TPS76050 LOW-POWER 50-mA LOW-DROPOUT LINEAR REGULATORS

SLVS144D – JULY 1998 – REVISED MAY 2001

**electrical characteristics over recommended operating free-air temperature range,
 $V_I = V_{O(nom)} + 1\text{ V}$, $I_O = 1\text{ mA}$, $EN = V_I$, $C_O = 2.2\text{ }\mu\text{F}$ (unless otherwise noted)**

PARAMETER		TEST CONDITIONS	MIN	TYP	MAX	UNIT		
V_O	Output voltage	TPS76030	$T_J = 25^\circ\text{C}$	2.96	3	3.04	V	
			$T_J = 25^\circ\text{C}$, $1\text{ mA} < I_O < 50\text{ mA}$	2.92		3.04		
			$1\text{ mA} < I_O < 50\text{ mA}$	2.91		3.07		
	Output voltage	TPS76032	TPS76032	$T_J = 25^\circ\text{C}$	3.16	3.2	3.24	V
				$T_J = 25^\circ\text{C}$, $1\text{ mA} < I_O < 50\text{ mA}$	3.13		3.24	
				$1\text{ mA} < I_O < 50\text{ mA}$	3.1		3.3	
	Output voltage	TPS76033	TPS76033	$T_J = 25^\circ\text{C}$	3.26	3.3	3.34	V
				$T_J = 25^\circ\text{C}$, $1\text{ mA} < I_O < 50\text{ mA}$	3.23		3.34	
				$1\text{ mA} < I_O < 50\text{ mA}$	3.2		3.4	
	Output voltage	TPS76038	TPS76038	$T_J = 25^\circ\text{C}$	3.76	3.8	3.84	V
				$T_J = 25^\circ\text{C}$, $1\text{ mA} < I_O < 50\text{ mA}$	3.73		3.84	
				$1\text{ mA} < I_O < 50\text{ mA}$	3.7		3.9	
	Output voltage	TPS76050	TPS76050	$T_J = 25^\circ\text{C}$	4.95	5	5.05	V
				$T_J = 25^\circ\text{C}$, $1\text{ mA} < I_O < 50\text{ mA}$	4.91		5.05	
				$1\text{ mA} < I_O < 50\text{ mA}$	4.89		5.1	
$I_{I(\text{standby})}$	Standby current	$EN = 0\text{ V}$			1	μA		
	Quiescent current (GND current)		$I_O = 0\text{ mA}$, $T_J = 25^\circ\text{C}$		90	115	μA	
			$I_O = 0\text{ mA}$			130		
			$I_O = 1\text{ mA}$, $T_J = 25^\circ\text{C}$		100	130		
			$I_O = 1\text{ mA}$			170		
			$I_O = 10\text{ mA}$, $T_J = 25^\circ\text{C}$		190	215		
			$I_O = 10\text{ mA}$			260		
			$I_O = 50\text{ mA}$, $T_J = 25^\circ\text{C}$		850	1100		
			$I_O = 50\text{ mA}$			1200		
Input regulation		TPS76030	$4\text{ V} < V_I < 16$, $I_O = 1\text{ mA}$		3	10	mV	
		TPS76032	$4.2\text{ V} < V_I < 16$, $I_O = 1\text{ mA}$		3	10		
		TPS76033	$4.3\text{ V} < V_I < 16$, $I_O = 1\text{ mA}$		3	10		
		TPS76038	$4.8\text{ V} < V_I < 16$, $I_O = 1\text{ mA}$		3	10		
		TPS76050	$6\text{ V} < V_I < 16$, $I_O = 1\text{ mA}$		3	10		
V_n	Output noise voltage	$BW = 300\text{ Hz to } 50\text{ kHz}$, $C_O = 10\text{ }\mu\text{F}$, $T_J = 25^\circ\text{C}$		190		μVrms		
	Ripple rejection	$f = 1\text{ kHz}$, $C_O = 10\text{ }\mu\text{F}$, $T_J = 25^\circ\text{C}$		63		dB		
Dropout voltage			$I_O = 0\text{ mA}$, $T_J = 25^\circ\text{C}$		1	3	mV	
			$I_O = 0\text{ mA}$			5		
			$I_O = 1\text{ mA}$, $T_J = 25^\circ\text{C}$		7	10		
			$I_O = 1\text{ mA}$			15		
			$I_O = 10\text{ mA}$, $T_J = 25^\circ\text{C}$		40	60		
			$I_O = 10\text{ mA}$			90		
			$I_O = 50\text{ mA}$, $T_J = 25^\circ\text{C}$		120	150		
			180					
	Peak output current/current limit		100	125	135	mA		
	High level enable input		2			V		
	Low level enable input				0.8	V		
I_I	Input current (EN)	$EN = 0\text{ V}$	-1	0	1	μA		
		$EN = V_I$		2.5	5	μA		



TPS76030, TPS76032, TPS76033, TPS76038, TPS76050 LOW-POWER 50-mA LOW-DROPOUT LINEAR REGULATORS

SLVS144D – JULY 1998 – REVISED MAY 2001

Table of Graphs

			FIGURE
V_O	Output voltage	vs Output current	1, 2, 3
		vs Free-air temperature	4, 5, 6
	Ground current	vs Free-air temperature	7, 8, 9
	Output noise	vs Frequency	10
Z_O	Output impedance	vs Frequency	11
V_{DO}	Dropout voltage	vs Free-air temperature	12
	Line transient response		13, 15
	Load transient response		14, 16



POST OFFICE BOX 655303 • DALLAS, TEXAS 75265

TYPICAL CHARACTERISTICS

TPS76030
 OUTPUT VOLTAGE
 vs
 OUTPUT CURRENT

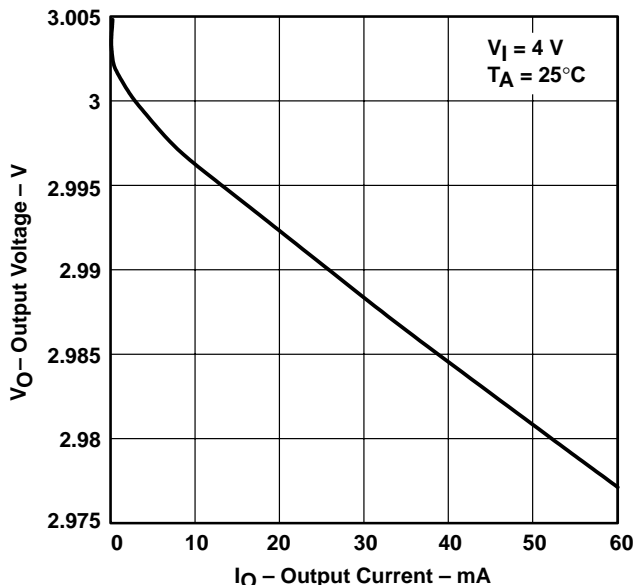

Figure 1

TPS76033
 OUTPUT VOLTAGE
 vs
 OUTPUT CURRENT

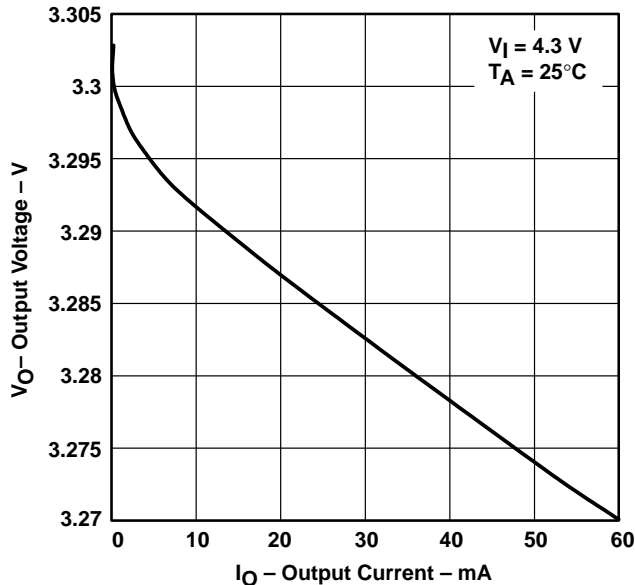

Figure 2

TPS76050
 OUTPUT VOLTAGE
 vs
 OUTPUT CURRENT

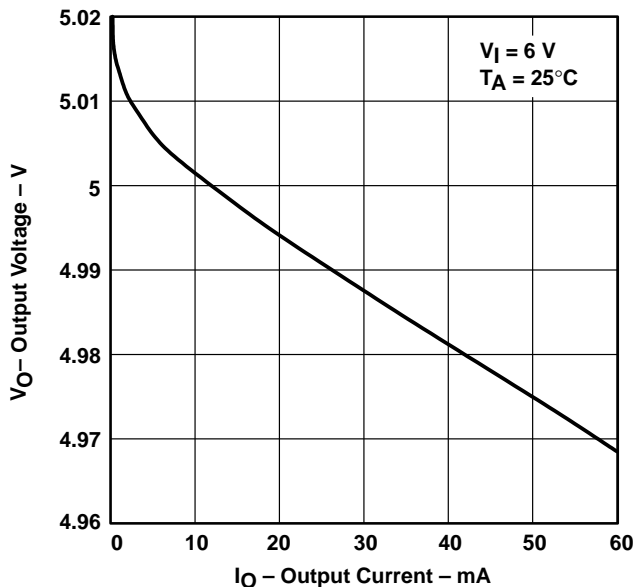

Figure 3

TPS76030
 OUTPUT VOLTAGE
 vs
 FREE-AIR TEMPERATURE

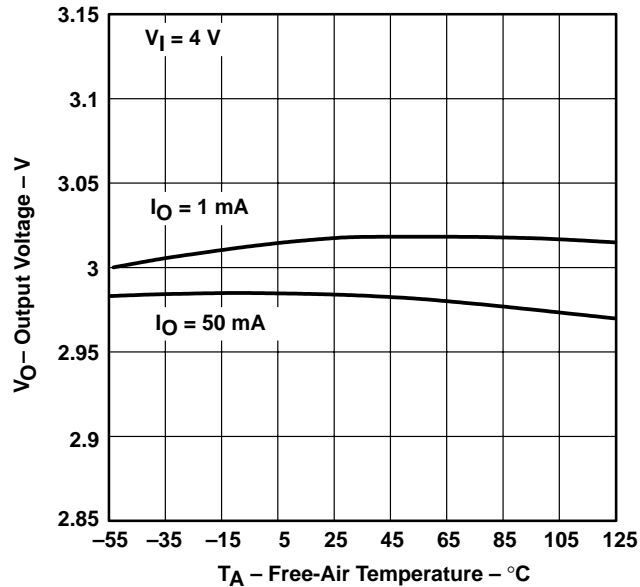

Figure 4

TPS76030, TPS76032, TPS76033, TPS76038, TPS76050 LOW-POWER 50-mA LOW-DROPOUT LINEAR REGULATORS

SLVS144D – JULY 1998 – REVISED MAY 2001

TYPICAL CHARACTERISTICS

TPS76033
OUTPUT VOLTAGE
vs
FREE-AIR TEMPERATURE

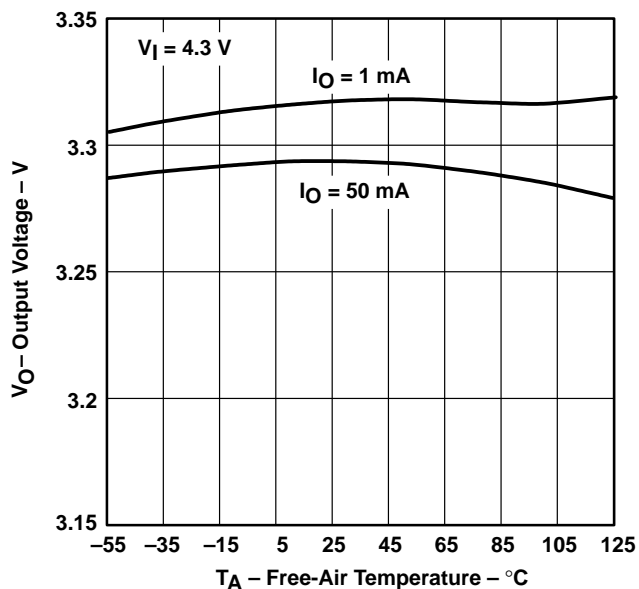

Figure 5

TPS76050
OUTPUT VOLTAGE
vs
FREE-AIR TEMPERATURE

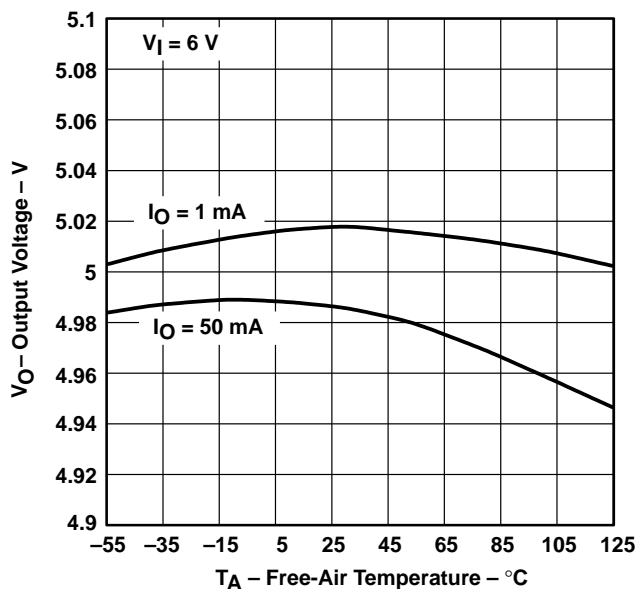

Figure 6

TPS76030
GROUND CURRENT
vs
FREE-AIR TEMPERATURE

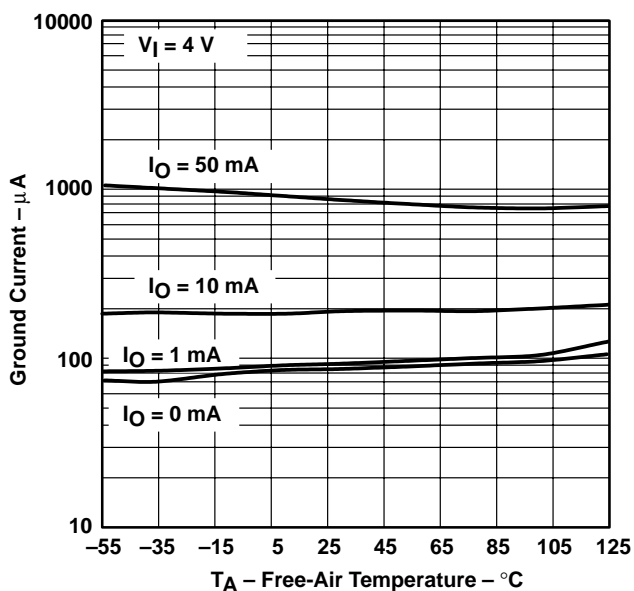

Figure 7

TPS76033
GROUND CURRENT
vs
FREE-AIR TEMPERATURE

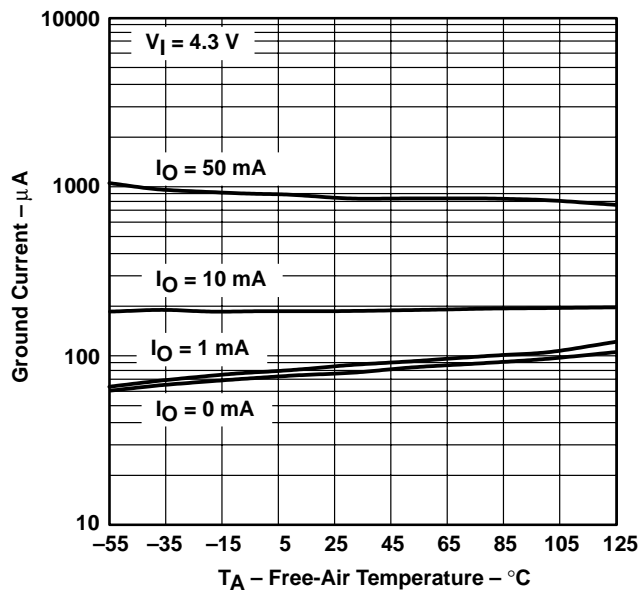
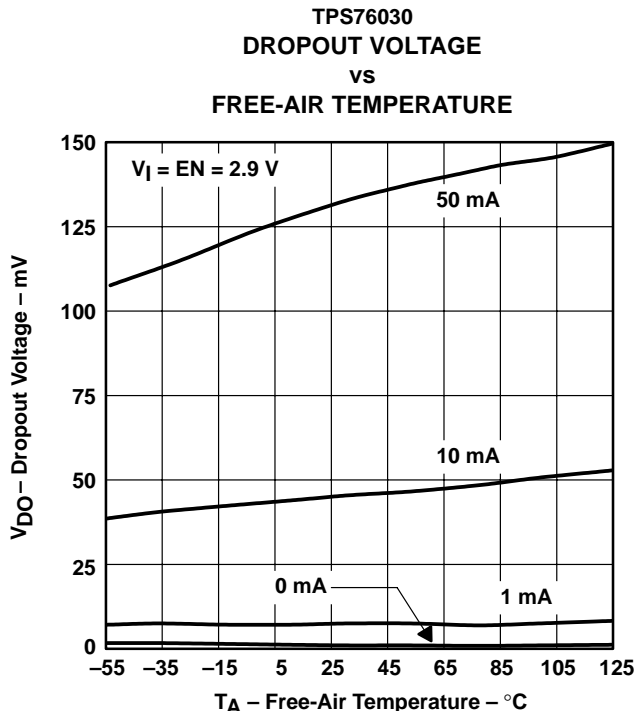
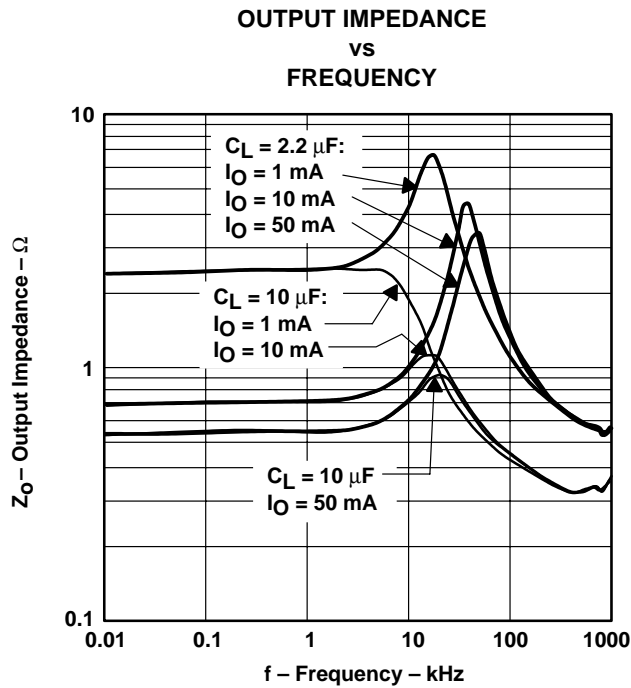
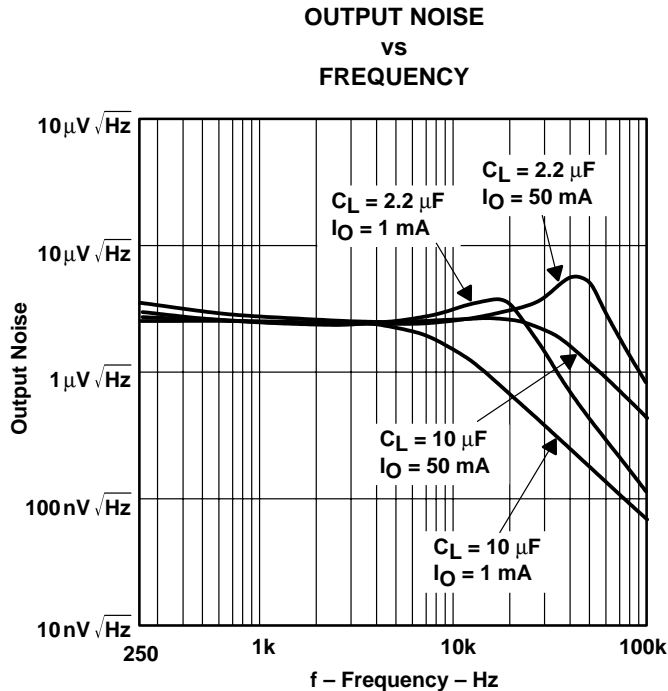
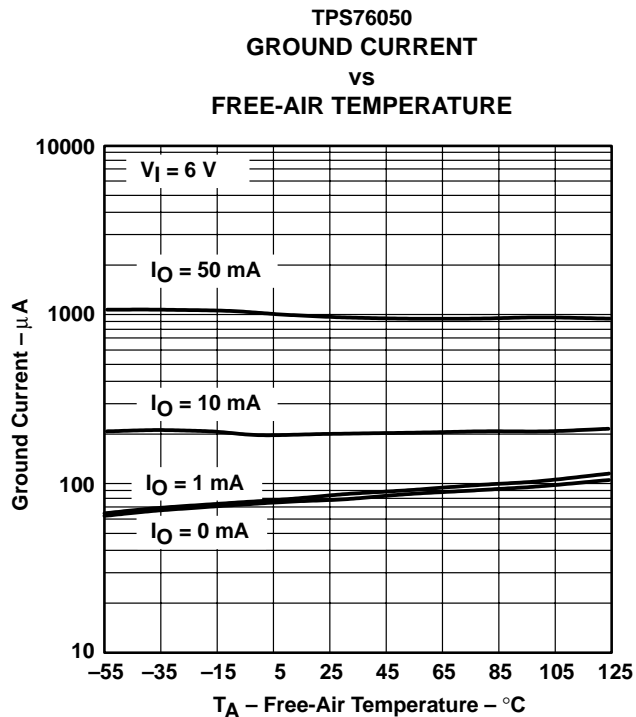

Figure 8



TYPICAL CHARACTERISTICS



TPS76030, TPS76032, TPS76033, TPS76038, TPS76050

LOW-POWER 50-mA LOW-DROPOUT LINEAR REGULATORS

SLVS144D – JULY 1998 – REVISED MAY 2001

TYPICAL CHARACTERISTICS

TPS76033
LINE TRANSIENT RESPONSE

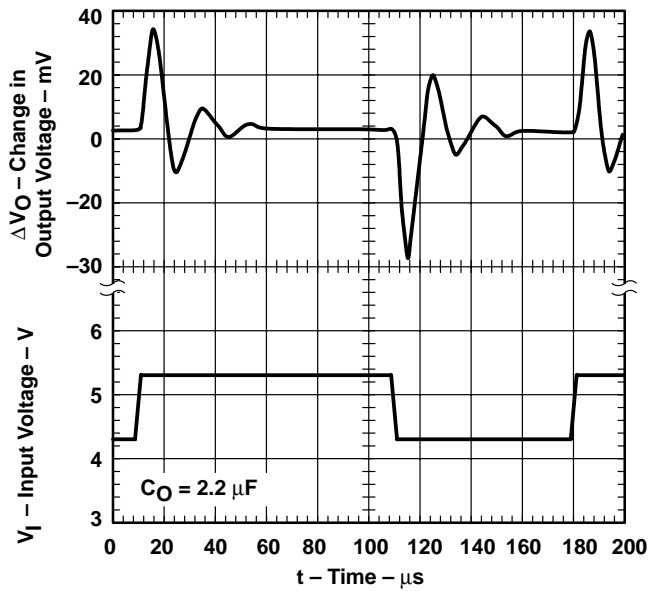

Figure 13

TPS76033
LOAD TRANSIENT RESPONSE

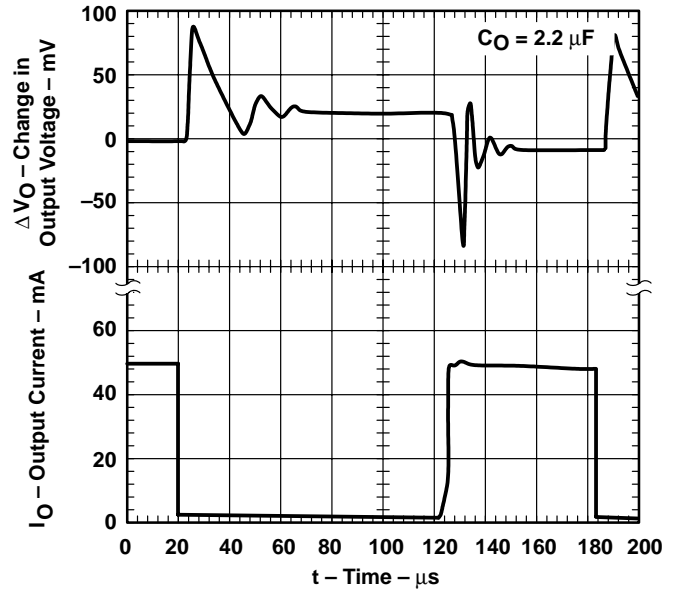

Figure 14

TPS76050
LINE TRANSIENT RESPONSE

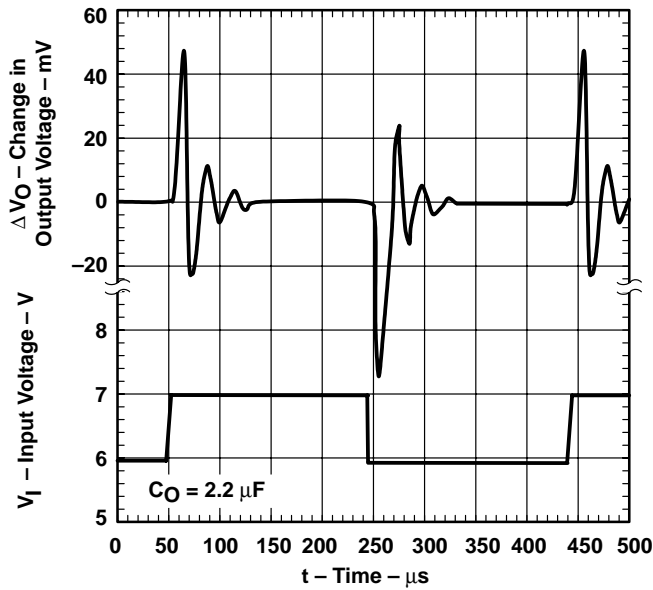

Figure 15

TPS76050
LOAD TRANSIENT RESPONSE

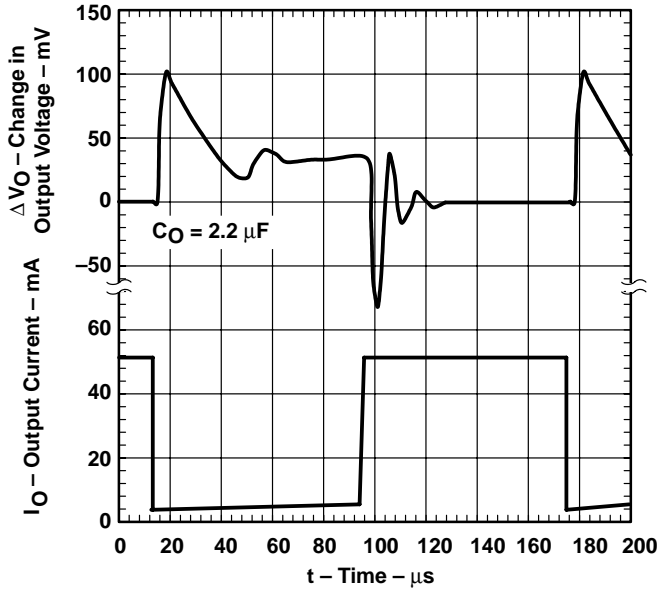

Figure 16

APPLICATION INFORMATION

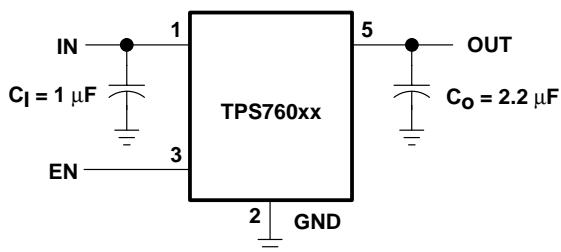

Figure 17. TPS760xx Typical Application

over current protection

The over current protection circuit forces the TPS760xx into a constant current output mode when the load is excessive or the output is shorted to ground. Normal operation resumes when the fault condition is removed. An overload or short circuit may also activate the over temperature protection if the fault condition persists.

over temperature protection

The thermal protection system shuts the TPS760xx down when the junction temperature exceeds 160°C. The device recovers and operates normally when the temperature drops below 155°C.

input capacitor

A 0.047 µF or larger ceramic decoupling capacitor with short leads connected between IN and GND is recommended. The decoupling capacitor may be omitted if there is a 1 µF or larger electrolytic capacitor connected between IN and GND and located reasonably close to the TPS760xx. However, the small ceramic device is desirable even when the larger capacitor is present, if there is a lot of high frequency noise present in the system.

output capacitor

Like all low dropout regulators, the TPS760xx requires an output capacitor connected between OUT and GND to stabilize the internal control loop. The minimum recommended capacitance value is 2.2 µF and the ESR (equivalent series resistance) must be between 0.1 Ω and 20 Ω. Capacitor values of 2.5-µF or larger are acceptable, provided the ESR is less than 20 Ω. Solid tantalum electrolytic, aluminum electrolytic, and multilayer ceramic capacitors are all suitable, provided they meet the requirements described above. Most of the commercially available 2.2-µF surface-mount solid-tantalum capacitors, including devices from Sprague, Kemet, and Nichicon, meet the ESR requirements stated above. Multilayer ceramic capacitors should have minimum values of 2.5 µF over the full operating temperature range of the equipment.

enable (EN)

A logic zero on the enable input shuts the TPS760xx off and reduces the supply current to less than 1 µA. Pulling the enable input high causes normal operation to resume. If the enable feature is not used, EN should be connected to IN to keep the regulator on all of the time. The EN input must not be left floating.

reverse current path

The power transistor used in the TPS760xx has an inherent diode connected between IN and OUT as shown in the functional block diagram. This diode conducts current from the OUT terminal to the IN terminal whenever IN is lower than OUT by a diode drop. This condition does not damage the TPS760xx, provided the current is limited to 100 mA.

PACKAGING INFORMATION

Orderable Device	Status (1)	Package Type	Package Drawing	Pins	Package Qty	Eco Plan (2)	Lead finish/ Ball material (6)	MSL Peak Temp (3)	Op Temp (°C)	Device Marking (4/5)	Samples
TPS76030DBVR	ACTIVE	SOT-23	DBV	5	3000	RoHS & Green	NIPDAU	Level-1-260C-UNLIM	-40 to 125	PAGI	Samples
TPS76030DBVT	ACTIVE	SOT-23	DBV	5	250	RoHS & Green	NIPDAU	Level-1-260C-UNLIM	-40 to 125	PAGI	Samples
TPS76032DBVR	ACTIVE	SOT-23	DBV	5	3000	RoHS & Green	NIPDAU	Level-1-260C-UNLIM	-40 to 125	PAOI	Samples
TPS76033DBVR	ACTIVE	SOT-23	DBV	5	3000	RoHS & Green	NIPDAU	Level-1-260C-UNLIM	-40 to 125	PAHI	Samples
TPS76033DBVT	ACTIVE	SOT-23	DBV	5	250	RoHS & Green	NIPDAU	Level-1-260C-UNLIM	-40 to 125	PAHI	Samples
TPS76038DBVR	ACTIVE	SOT-23	DBV	5	3000	RoHS & Green	NIPDAU	Level-1-260C-UNLIM	-40 to 125	PAJI	Samples
TPS76038DBVT	ACTIVE	SOT-23	DBV	5	250	RoHS & Green	NIPDAU	Level-1-260C-UNLIM	-40 to 125	PAJI	Samples
TPS76050DBVR	ACTIVE	SOT-23	DBV	5	3000	RoHS & Green	NIPDAU	Level-1-260C-UNLIM	-40 to 125	PANI	Samples
TPS76050DBVRG4	ACTIVE	SOT-23	DBV	5	3000	RoHS & Green	NIPDAU	Level-1-260C-UNLIM	-40 to 125	PANI	Samples
TPS76050DBVT	ACTIVE	SOT-23	DBV	5	250	RoHS & Green	NIPDAU	Level-1-260C-UNLIM	-40 to 125	PANI	Samples

(1) The marketing status values are defined as follows:

ACTIVE: Product device recommended for new designs.

LIFEBUY: TI has announced that the device will be discontinued, and a lifetime-buy period is in effect.

NRND: Not recommended for new designs. Device is in production to support existing customers, but TI does not recommend using this part in a new design.

PREVIEW: Device has been announced but is not in production. Samples may or may not be available.

OBSOLETE: TI has discontinued the production of the device.

(2) **RoHS:** TI defines "RoHS" to mean semiconductor products that are compliant with the current EU RoHS requirements for all 10 RoHS substances, including the requirement that RoHS substance do not exceed 0.1% by weight in homogeneous materials. Where designed to be soldered at high temperatures, "RoHS" products are suitable for use in specified lead-free processes. TI may reference these types of products as "Pb-Free".

RoHS Exempt: TI defines "RoHS Exempt" to mean products that contain lead but are compliant with EU RoHS pursuant to a specific EU RoHS exemption.

Green: TI defines "Green" to mean the content of Chlorine (Cl) and Bromine (Br) based flame retardants meet JS709B low halogen requirements of <=1000ppm threshold. Antimony trioxide based flame retardants must also meet the <=1000ppm threshold requirement.

(3) MSL, Peak Temp. - The Moisture Sensitivity Level rating according to the JEDEC industry standard classifications, and peak solder temperature.

(4) There may be additional marking, which relates to the logo, the lot trace code information, or the environmental category on the device.

⁽⁵⁾ Multiple Device Markings will be inside parentheses. Only one Device Marking contained in parentheses and separated by a "~" will appear on a device. If a line is indented then it is a continuation of the previous line and the two combined represent the entire Device Marking for that device.

⁽⁶⁾ Lead finish/Ball material - Orderable Devices may have multiple material finish options. Finish options are separated by a vertical ruled line. Lead finish/Ball material values may wrap to two lines if the finish value exceeds the maximum column width.

Important Information and Disclaimer:The information provided on this page represents TI's knowledge and belief as of the date that it is provided. TI bases its knowledge and belief on information provided by third parties, and makes no representation or warranty as to the accuracy of such information. Efforts are underway to better integrate information from third parties. TI has taken and continues to take reasonable steps to provide representative and accurate information but may not have conducted destructive testing or chemical analysis on incoming materials and chemicals. TI and TI suppliers consider certain information to be proprietary, and thus CAS numbers and other limited information may not be available for release.

In no event shall TI's liability arising out of such information exceed the total purchase price of the TI part(s) at issue in this document sold by TI to Customer on an annual basis.

TAPE AND REEL INFORMATION



QUADRANT ASSIGNMENTS FOR PIN 1 ORIENTATION IN TAPE



*All dimensions are nominal

Device	Package Type	Package Drawing	Pins	SPQ	Reel Diameter (mm)	Reel Width W1 (mm)	A0 (mm)	B0 (mm)	K0 (mm)	P1 (mm)	W (mm)	Pin1 Quadrant
TPS76030DBVR	SOT-23	DBV	5	3000	180.0	9.0	3.15	3.2	1.4	4.0	8.0	Q3
TPS76030DBVT	SOT-23	DBV	5	250	180.0	9.0	3.15	3.2	1.4	4.0	8.0	Q3
TPS76032DBVR	SOT-23	DBV	5	3000	180.0	9.0	3.15	3.2	1.4	4.0	8.0	Q3
TPS76033DBVR	SOT-23	DBV	5	3000	178.0	9.0	3.23	3.17	1.37	4.0	8.0	Q3
TPS76033DBVT	SOT-23	DBV	5	250	178.0	9.0	3.23	3.17	1.37	4.0	8.0	Q3
TPS76038DBVR	SOT-23	DBV	5	3000	180.0	9.0	3.15	3.2	1.4	4.0	8.0	Q3
TPS76038DBVT	SOT-23	DBV	5	250	180.0	9.0	3.15	3.2	1.4	4.0	8.0	Q3
TPS76050DBVR	SOT-23	DBV	5	3000	178.0	9.0	3.23	3.17	1.37	4.0	8.0	Q3
TPS76050DBVT	SOT-23	DBV	5	250	178.0	9.0	3.23	3.17	1.37	4.0	8.0	Q3

TAPE AND REEL BOX DIMENSIONS

*All dimensions are nominal

Device	Package Type	Package Drawing	Pins	SPQ	Length (mm)	Width (mm)	Height (mm)
TPS76030DBVR	SOT-23	DBV	5	3000	182.0	182.0	20.0
TPS76030DBVT	SOT-23	DBV	5	250	182.0	182.0	20.0
TPS76032DBVR	SOT-23	DBV	5	3000	182.0	182.0	20.0
TPS76033DBVR	SOT-23	DBV	5	3000	180.0	180.0	18.0
TPS76033DBVT	SOT-23	DBV	5	250	180.0	180.0	18.0
TPS76038DBVR	SOT-23	DBV	5	3000	182.0	182.0	20.0
TPS76038DBVT	SOT-23	DBV	5	250	182.0	182.0	20.0
TPS76050DBVR	SOT-23	DBV	5	3000	180.0	180.0	18.0
TPS76050DBVT	SOT-23	DBV	5	250	180.0	180.0	18.0

DBV0005A



PACKAGE OUTLINE

SOT-23 - 1.45 mm max height

SMALL OUTLINE TRANSISTOR

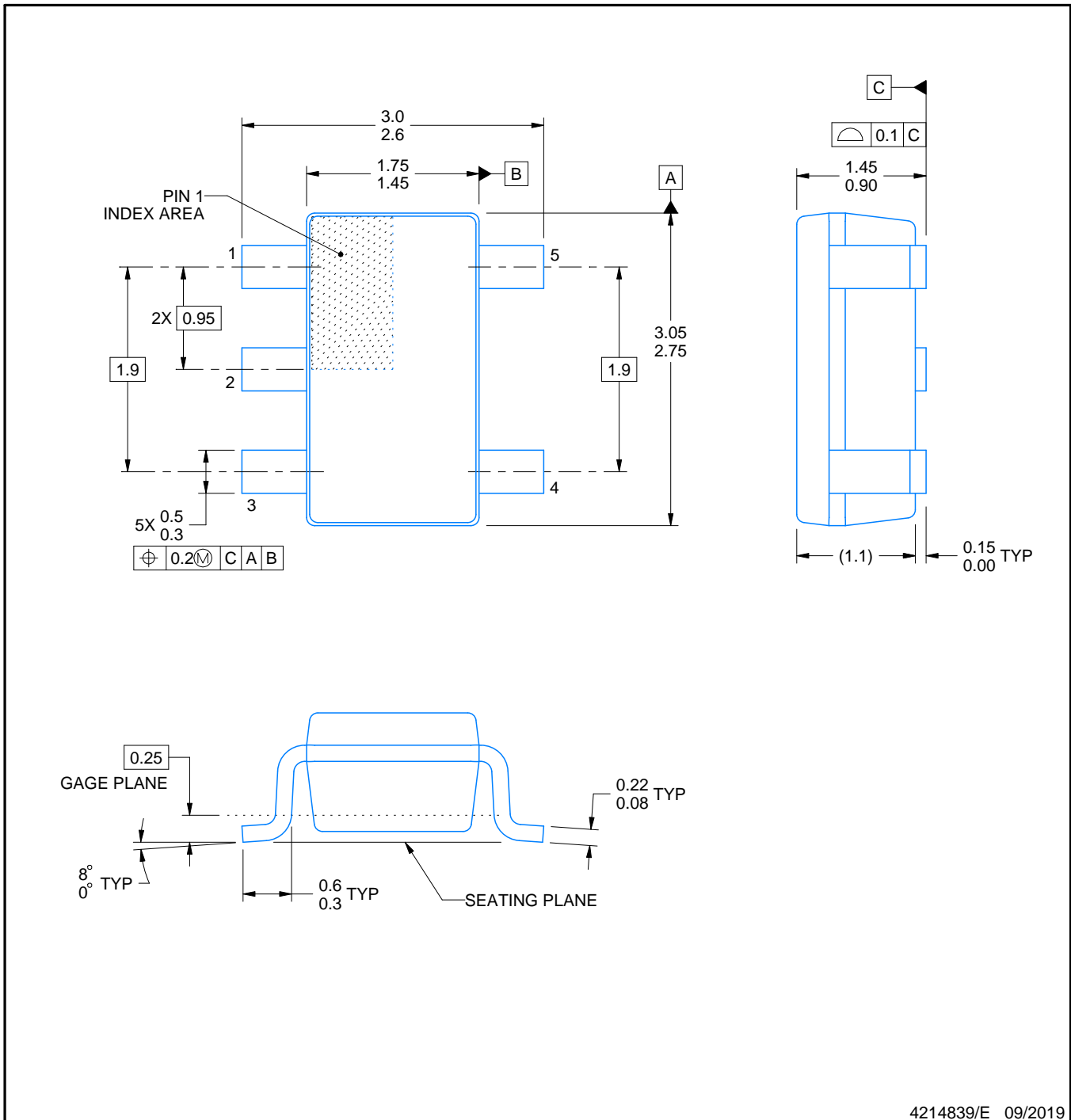

4214839/E 09/2019

NOTES:

1. All linear dimensions are in millimeters. Any dimensions in parenthesis are for reference only. Dimensioning and tolerancing per ASME Y14.5M.
2. This drawing is subject to change without notice.
3. Reference JEDEC MO-178.
4. Body dimensions do not include mold flash, protrusions, or gate burrs. Mold flash, protrusions, or gate burrs shall not exceed 0.15 mm per side.

EXAMPLE BOARD LAYOUT

DBV0005A

SOT-23 - 1.45 mm max height

SMALL OUTLINE TRANSISTOR



LAND PATTERN EXAMPLE
EXPOSED METAL SHOWN
SCALE:15X



SOLDER MASK DETAILS

4214839/E 09/2019

NOTES: (continued)

- 5. Publication IPC-7351 may have alternate designs.
- 6. Solder mask tolerances between and around signal pads can vary based on board fabrication site.

EXAMPLE STENCIL DESIGN

DBV0005A

SOT-23 - 1.45 mm max height

SMALL OUTLINE TRANSISTOR



SOLDER PASTE EXAMPLE
BASED ON 0.125 mm THICK STENCIL
SCALE:15X

4214839/E 09/2019

NOTES: (continued)

7. Laser cutting apertures with trapezoidal walls and rounded corners may offer better paste release. IPC-7525 may have alternate design recommendations.
8. Board assembly site may have different recommendations for stencil design.



DBV0005A

PACKAGE OUTLINE

SOT-23 - 1.45 mm max height

SMALL OUTLINE TRANSISTOR

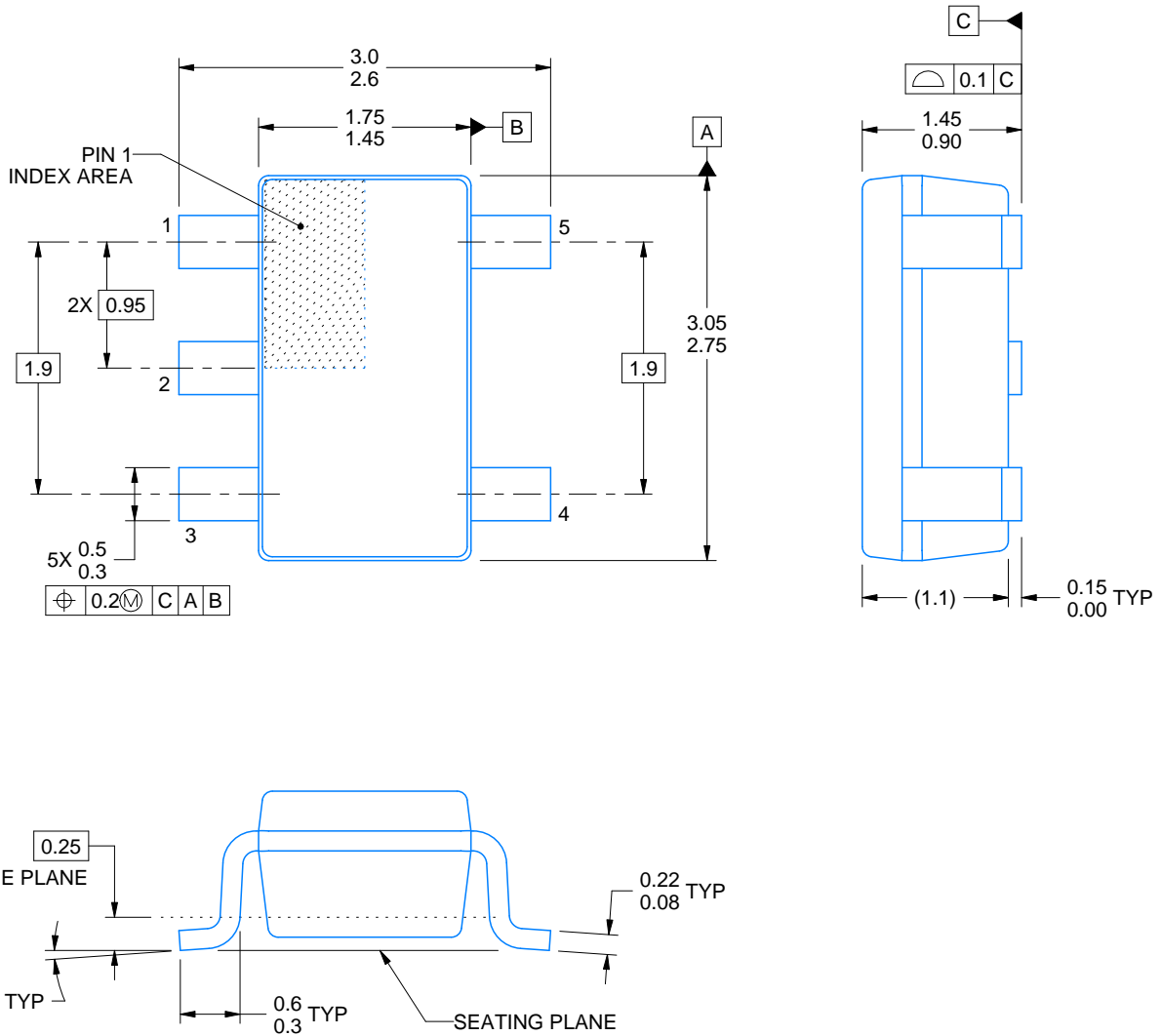

4214839/F 06/2021

NOTES:

1. All linear dimensions are in millimeters. Any dimensions in parenthesis are for reference only. Dimensioning and tolerancing per ASME Y14.5M.
2. This drawing is subject to change without notice.
3. Reference JEDEC MO-178.
4. Body dimensions do not include mold flash, protrusions, or gate burrs. Mold flash, protrusions, or gate burrs shall not exceed 0.25 mm per side.

EXAMPLE BOARD LAYOUT

DBV0005A

SOT-23 - 1.45 mm max height

SMALL OUTLINE TRANSISTOR



LAND PATTERN EXAMPLE
EXPOSED METAL SHOWN
SCALE:15X

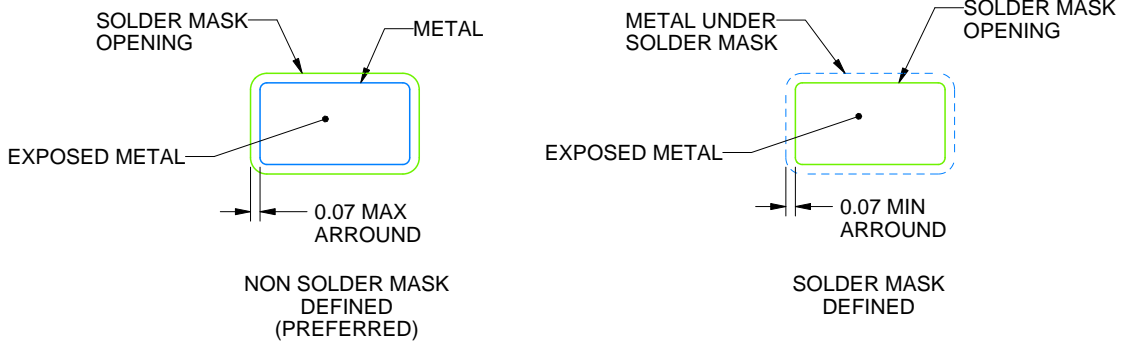

SOLDER MASK DETAILS

4214839/F 06/2021

NOTES: (continued)

- 5. Publication IPC-7351 may have alternate designs.
- 6. Solder mask tolerances between and around signal pads can vary based on board fabrication site.

EXAMPLE STENCIL DESIGN

DBV0005A

SOT-23 - 1.45 mm max height

SMALL OUTLINE TRANSISTOR



SOLDER PASTE EXAMPLE
BASED ON 0.125 mm THICK STENCIL
SCALE:15X

4214839/F 06/2021

NOTES: (continued)

7. Laser cutting apertures with trapezoidal walls and rounded corners may offer better paste release. IPC-7525 may have alternate design recommendations.
8. Board assembly site may have different recommendations for stencil design.

IMPORTANT NOTICE AND DISCLAIMER

TI PROVIDES TECHNICAL AND RELIABILITY DATA (INCLUDING DATASHEETS), DESIGN RESOURCES (INCLUDING REFERENCE DESIGNS), APPLICATION OR OTHER DESIGN ADVICE, WEB TOOLS, SAFETY INFORMATION, AND OTHER RESOURCES "AS IS" AND WITH ALL FAULTS, AND DISCLAIMS ALL WARRANTIES, EXPRESS AND IMPLIED, INCLUDING WITHOUT LIMITATION ANY IMPLIED WARRANTIES OF MERCHANTABILITY, FITNESS FOR A PARTICULAR PURPOSE OR NON-INFRINGEMENT OF THIRD PARTY INTELLECTUAL PROPERTY RIGHTS.

These resources are intended for skilled developers designing with TI products. You are solely responsible for (1) selecting the appropriate TI products for your application, (2) designing, validating and testing your application, and (3) ensuring your application meets applicable standards, and any other safety, security, or other requirements. These resources are subject to change without notice. TI grants you permission to use these resources only for development of an application that uses the TI products described in the resource. Other reproduction and display of these resources is prohibited. No license is granted to any other TI intellectual property right or to any third party intellectual property right. TI disclaims responsibility for, and you will fully indemnify TI and its representatives against, any claims, damages, costs, losses, and liabilities arising out of your use of these resources.

TI's products are provided subject to TI's Terms of Sale (<https://www.ti.com/legal/termsofsale.html>) or other applicable terms available either on [ti.com](https://www.ti.com) or provided in conjunction with such TI products. TI's provision of these resources does not expand or otherwise alter TI's applicable warranties or warranty disclaimers for TI products.

Mailing Address: Texas Instruments, Post Office Box 655303, Dallas, Texas 75265
Copyright © 2021, Texas Instruments Incorporated