

## TVS DIODE

### FEATURES

- Built-in strain relief
- Glass passivated junction
- Low inductance
- Excellent clamping capability
- Repetition Rate (duty cycle):0.01%
- Fast response time: typically less than 1.0ps  
from 0 Volts to V(BR) for unidirectional types
- Typical IR less than 1mA above 10V
- High temperature soldering guaranteed: 260°C/10 seconds,
- Small Surface Mount device

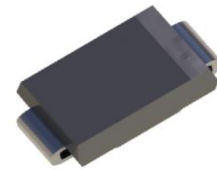

**SMA**

### MECHANICAL DATA

- Case: SMA(DO-214AC)
- Case Material: Molded Plastic. UL flammability
- Classification Rating: 94V-0
- Weight: 0.065 grams (approximate)

### MAXIMUM RATINGS AND CHARACTERISTICS(T<sub>A</sub> = 25°C unless otherwise noted)

Parameter	Symbol	Value	UNIT
Peak power dissipation with a 10/1000µs waveform <sup>(1)</sup>	P <sub>PP</sub>	400	W
Peak pulse current with a 10/1000µs waveform <sup>(1)</sup>	I <sub>PP</sub>	See Next Table	A
Power dissipation on infinite heatsink at T <sub>L</sub> = 75 °C	P <sub>D</sub>	1.0	W
Peak forward surge current, 8.3 ms single half sine-wave unidirectional only <sup>(2)</sup>	I <sub>FSM</sub>	40	A
Maximum instantaneous forward voltage at 25 A for unidirectional only <sup>(3)</sup>	V <sub>F</sub>	3.5/5.0	V
Operating junction and storage temperature range	T <sub>J</sub> , T <sub>STG</sub>	-55 to +150	°C

#### Note:

(1)Non-repetitive current pulse per Fig.5 and derated above T<sub>A</sub>= 25 °C per Fig.1

(2)Measured on 8.3 ms single half sine-wave or equivalent square wave, duty cycle = 4 pulses per minute maximum

(3)V<sub>F</sub><3.5V for devices of V<sub>BR</sub><200V and V<sub>F</sub><5.0V for devices of V<sub>BR</sub>>201V

## TVS DIODE

### ELECTRICAL CHARACTERISTICS ( $T_A=25^{\circ}\text{C}$ unless otherwise noted)

Part Number (Uni)	Part Number (Bi)	Device Marking Code		Breakdown Voltage $V_{BR}$ @ $I_T$			Maximum Reverse Leakage $I_R$ @ $V_{RWM}$ ( $\mu\text{A}$ )	Working Peak Reverse Voltage $V_{RWM}$ (V)	Maximum Reverse Surge Current $I_{PP}$ (A)	Maximum Clamping Voltage $V_C$ @ $I_{PP}$ (V)
		Uni	Bi	Min (V)	Max (V)	$I_T$ (mA)				
SMAJ5.0	SMAJ5.0C	AD	WD	6.40	7.30	10	800	5.0	41.67	9.6
SMAJ5.0A	SMAJ5.0CA	AE	WE	6.40	7.00	10	800	5.0	43.48	9.2
SMAJ6.0	SMAJ6.0C	AF	WF	6.67	8.15	10	800	6.0	35.09	11.4
SMAJ6.0A	SMAJ6.0CA	AG	WG	6.67	7.37	10	800	6.0	38.83	10.3
SMAJ6.5	SMAJ6.5C	AH	WH	7.22	8.82	10	500	6.5	32.52	12.3
SMAJ6.5A	SMAJ6.5CA	AK	WK	7.22	7.98	10	500	6.5	35.71	11.2
SMAJ7.0	SMAJ7.0C	AL	WL	7.78	9.51	10	200	7.0	30.08	13.3
SMAJ7.0A	SMAJ7.0CA	AM	WM	7.78	8.60	10	200	7.0	33.33	12.0
SMAJ7.5	SMAJ7.5C	AN	WN	8.33	10.20	1	100	7.5	27.97	14.3
SMAJ7.5A	SMAJ7.5CA	AP	WP	8.33	9.21	1	100	7.5	31.01	12.9
SMAJ8.0	SMAJ8.0C	AQ	WQ	8.89	10.90	1	50	8.0	26.67	15.0
SMAJ8.0A	SMAJ8.0CA	AR	WR	8.89	9.83	1	50	8.0	29.41	13.6
SMAJ8.5	SMAJ8.5C	AS	WS	9.44	11.50	1	10	8.5	25.16	15.9
SMAJ8.5A	SMAJ8.5CA	AT	WT	9.44	10.40	1	10	8.5	27.78	14.4
SMAJ9.0	SMAJ9.0C	AU	WU	10.00	12.20	1	5	9.0	23.67	16.9
SMAJ9.0A	SMAJ9.0CA	AV	WV	10.00	11.10	1	5	9.0	25.97	15.4
SMAJ10	SMAJ10C	AW	WW	11.10	13.60	1	5	10.0	21.28	18.8
SMAJ10A	SMAJ10CA	AX	WX	11.10	12.30	1	5	10.0	23.53	17.0
SMAJ11	SMAJ11C	AY	WY	12.20	14.90	1	1	11.0	19.90	20.1
SMAJ11A	SMAJ11CA	AZ	WZ	12.20	13.50	1	1	11.0	21.98	18.2
SMAJ12	SMAJ12C	BD	XD	13.30	16.30	1	1	12.0	18.18	22.0
SMAJ12A	SMAJ12CA	BE	XE	13.30	14.70	1	1	12.0	20.10	19.9
SMAJ13	SMAJ13C	BF	XF	14.40	17.60	1	1	13.0	16.81	23.8
SMAJ13A	SMAJ13CA	BG	XG	14.40	15.90	1	1	13.0	18.60	21.5
SMAJ14	SMAJ14C	BH	XH	15.60	19.10	1	1	14.0	15.50	25.8
SMAJ14A	SMAJ14CA	BK	XK	15.60	17.20	1	1	14.0	17.24	23.2
SMAJ15	SMAJ15C	BL	XL	16.70	20.40	1	1	15.0	14.87	26.9
SMAJ15A	SMAJ15CA	BM	XM	16.70	18.50	1	1	15.0	16.39	24.4
SMAJ16	SMAJ16C	BN	XN	17.80	21.80	1	1	16.0	13.89	28.8
SMAJ16A	SMAJ16CA	BP	XP	17.80	19.70	1	1	16.0	15.38	26.0
SMAJ17	SMAJ17C	BQ	XQ	18.90	23.10	1	1	17.0	13.11	30.5
SMAJ17A	SMAJ17CA	BR	XR	18.90	20.90	1	1	17.0	14.49	27.6
SMAJ18	SMAJ18C	BS	XS	20.00	24.40	1	1	18.0	12.42	32.2
SMAJ18A	SMAJ18CA	BT	XT	20.00	22.10	1	1	18.0	13.70	29.2
SMAJ19	SMAJ19C	BA	XA	21.13	25.76	1	1	19.0	11.76	34.0
SMAJ19A	SMAJ19CA	BB	XB	21.10	23.30	1	1	19.0	13.00	30.8
SMAJ20	SMAJ20C	BU	XU	22.20	27.10	1	1	20.0	11.17	35.8
SMAJ20A	SMAJ20CA	BV	XV	22.20	24.50	1	1	20.0	12.35	32.4
SMAJ22	SMAJ22C	BW	XW	24.40	29.80	1	1	22.0	10.15	39.4
SMAJ22A	SMAJ22CA	BX	XX	24.40	26.90	1	1	22.0	11.27	35.5
SMAJ24	SMAJ24C	BY	XY	26.70	32.60	1	1	24.0	9.30	43.0
SMAJ24A	SMAJ24CA	BZ	XZ	26.70	29.50	1	1	24.0	10.28	38.9
SMAJ26	SMAJ26C	CD	YD	28.90	35.30	1	1	26.0	8.58	46.6
SMAJ26A	SMAJ26CA	CE	YE	28.90	31.90	1	1	26.0	9.50	42.1
SMAJ28	SMAJ28C	CF	YF	31.10	38.00	1	1	28.0	8.00	50.0
SMAJ28A	SMAJ28CA	CG	YG	31.10	34.40	1	1	28.0	8.81	45.4
SMAJ30	SMAJ30C	CH	YH	33.30	40.70	1	1	30.0	7.48	53.5
SMAJ30A	SMAJ30CA	CK	YK	33.30	36.80	1	1	30.0	8.26	48.4
SMAJ33	SMAJ33C	CL	YL	36.70	44.90	1	1	33.0	6.78	59.0
SMAJ33A	SMAJ33CA	CM	YM	36.70	40.60	1	1	33.0	7.50	53.3
SMAJ36	SMAJ36C	CN	YN	40.00	48.90	1	1	36.0	6.22	64.3
SMAJ36A	SMAJ36CA	CP	YP	40.00	44.20	1	1	36.0	6.88	58.1

## TVS DIODE

Part Number (Uni)	Part Number (Bi)	Device Marking Code		Breakdown Voltage $V_{BR}$ @ $I_T$			Maximum Reverse Leakage $I_R$ @ $V_{RWM}$ (uA)	Working Peak Reverse Voltage $V_{RWM}$ (V)	Maximum Reverse Surge Current $I_{PP}$ (A)	Maximum Clamping Voltage $V_C$ @ $I_{PP}$ (V)
		Uni	Bi	Min (V)	Max (V)	$I_T$ (mA)				
SMAJ40	SMAJ40C	CQ	YQ	44.40	54.30	1	1	40.0	5.60	71.4
SMAJ40A	SMAJ40CA	CR	YR	44.40	49.10	1	1	40.0	6.20	64.5
SMAJ43	SMAJ43C	CS	YS	47.80	58.40	1	1	43.0	5.22	76.7
SMAJ43A	SMAJ43CA	CT	YT	47.80	52.80	1	1	43.0	5.76	69.4
SMAJ45	SMAJ45C	CU	YU	50.00	61.10	1	1	45.0	4.98	80.3
SMAJ45A	SMAJ45CA	CV	YV	50.00	55.30	1	1	45.0	5.50	72.7
SMAJ48	SMAJ48C	CW	YW	53.30	65.10	1	1	48.0	4.68	85.5
SMAJ48A	SMAJ48CA	CX	YX	53.30	58.90	1	1	48.0	5.17	77.4
SMAJ51	SMAJ51C	CY	YY	56.70	69.30	1	1	51.0	4.39	91.1
SMAJ51A	SMAJ51CA	CZ	YZ	56.70	62.70	1	1	51.0	4.85	82.4
SMAJ54	SMAJ54C	RD	ZD	60.00	73.30	1	1	54.0	4.15	96.3
SMAJ54A	SMAJ54CA	RE	ZE	60.00	66.30	1	1	54.0	4.59	87.1
SMAJ58	SMAJ58C	RF	ZF	64.40	78.70	1	1	58.0	3.88	103.0
SMAJ58A	SMAJ58CA	RG	ZG	64.40	71.20	1	1	58.0	4.27	93.6
SMAJ60	SMAJ60C	RH	ZH	66.70	81.50	1	1	60.0	3.74	107.0
SMAJ60A	SMAJ60CA	RK	ZK	66.70	73.70	1	1	60.0	4.13	96.8
SMAJ64	SMAJ64C	RL	ZL	71.10	86.90	1	1	64.0	3.51	114.0
SMAJ64A	SMAJ64CA	RM	ZM	71.10	78.60	1	1	64.0	3.88	103.0
SMAJ70	SMAJ70C	RN	ZN	77.80	95.10	1	1	70.0	3.20	125.0
SMAJ70A	SMAJ70CA	RP	ZP	77.80	86.00	1	1	70.0	3.54	113.0
SMAJ75	SMAJ75C	RQ	ZQ	83.30	102.00	1	1	75.0	2.99	134.0
SMAJ75A	SMAJ75CA	RR	ZR	83.30	92.10	1	1	75.0	3.31	121.0
SMAJ78	SMAJ78C	RS	ZS	86.70	106.00	1	1	78.0	2.88	139.0
SMAJ78A	SMAJ78CA	RT	ZT	86.70	95.80	1	1	78.0	3.17	126.0
SMAJ80	SMAJ80C	RA	ZA	88.96	108.80	1	1	80.0	2.79	143.2
SMAJ80A	SMAJ80CA	RB	ZB	88.80	97.60	1	1	80.0	3.09	129.6
SMAJ85	SMAJ85C	RU	ZU	94.40	115.00	1	1	85.0	2.65	151.0
SMAJ85A	SMAJ85CA	RV	ZV	94.40	104.00	1	1	85.0	2.92	137.0
SMAJ90	SMAJ90C	RW	ZW	100.00	122.00	1	1	90.0	2.50	160.0
SMAJ90A	SMAJ90CA	RX	ZX	100.00	111.00	1	1	90.0	2.74	146.0
SMAJ100	SMAJ100C	RY	ZY	111.00	136.00	1	1	100.0	2.23	179.0
SMAJ100A	SMAJ100CA	RZ	ZZ	111.00	123.00	1	1	100.0	2.47	162.0
SMAJ110	SMAJ110C	SD	VD	122.00	149.00	1	1	110.0	2.04	196.0
SMAJ110A	SMAJ110CA	SE	VE	122.00	135.00	1	1	110.0	2.26	177.0
SMAJ120	SMAJ120C	SF	VF	133.00	163.00	1	1	120.0	1.87	214.0
SMAJ120A	SMAJ120CA	SG	VG	133.00	147.00	1	1	120.0	2.07	193.0
SMAJ130	SMAJ130C	SH	VH	144.00	176.00	1	1	130.0	1.73	231.0
SMAJ130A	SMAJ130CA	SK	VK	144.00	159.00	1	1	130.0	1.91	209.0
SMAJ140	SMAJ140C	SA	VA	155.68	190.40	1	1	140.0	1.60	250.6
SMAJ140A	SMAJ140CA	SB	VB	155.00	171.00	1	1	140.0	1.76	226.8
SMAJ150	SMAJ150C	SL	VL	167.00	204.00	1	1	150.0	1.49	268.0
SMAJ150A	SMAJ150CA	SM	VM	167.00	185.00	1	1	150.0	1.65	243.0
SMAJ160	SMAJ160C	SN	VN	178.00	218.00	1	1	160.0	1.39	287.0
SMAJ160A	SMAJ160CA	SP	VP	178.00	197.00	1	1	160.0	1.54	259.0
SMAJ170	SMAJ170C	SQ	VQ	189.00	231.00	1	1	170.0	1.32	304.0
SMAJ170A	SMAJ170CA	SR	VR	189.00	209.00	1	1	170.0	1.45	275.0
SMAJ180	SMAJ180C	SS	VS	200.16	244.80	1	1	180.0	1.24	322.2
SMAJ180A	SMAJ180CA	ST	VT	200.00	220.00	1	1	180.0	1.37	291.6
SMAJ190	SMAJ190C	SU	VU	211.28	258.40	1	1	190.0	1.18	340.1
SMAJ190A	SMAJ190CA	SV	VV	211.00	232.00	1	1	190.0	1.30	307.8
SMAJ200A	SMAJ200CA	SW	VW	224.00	247.00	1	1	200.0	1.23	324.0
SMAJ220A	SMAJ220CA	SX	VX	246.00	272.00	1	1	220.0	1.12	356.0
SMAJ250A	SMAJ250CA	SZ	VZ	279.00	309.00	1	1	250.0	0.99	405.0
SMAJ300A	SMAJ300CA	DE	HE	335.00	371.00	1	1	300.0	0.82	486.0
SMAJ350A	SMAJ350CA	DG	HG	391.00	432.00	1	1	350.0	0.71	567.0
SMAJ400A	SMAJ400CA	DK	HK	447.00	494.00	1	1	400.0	0.62	648.0
SMAJ440A	SMAJ440CA	DM	HM	492.00	543.00	1	1	440.0	0.56	713.0

### Note:

1. Suffix 'A' denotes 5% tolerance device. Without 'A' denotes 10% tolerance device
2. Add suffix 'C' or 'CA' after part number to specify Bi-directional devices
3. For Bi-Directional devices having  $V_R$  of 10 volts and under, the  $I_R$  limit is double

**Typical Characteristics**

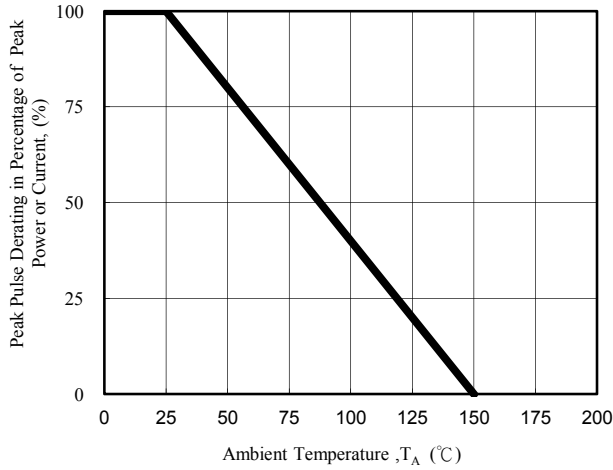

Fig. 1 - Pulse Derating Curve

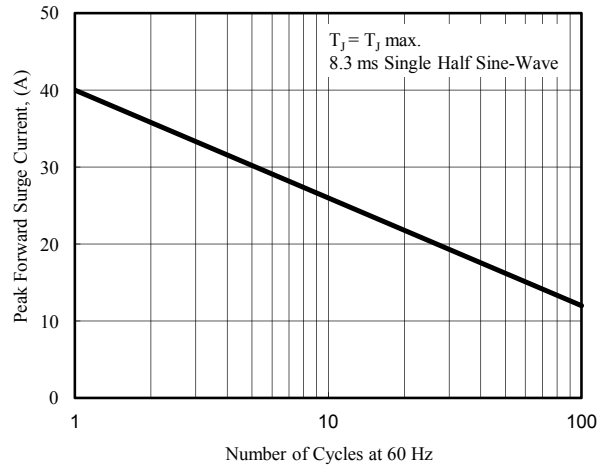

Fig. 2 - Maximum Non-Repetitive Surge Current

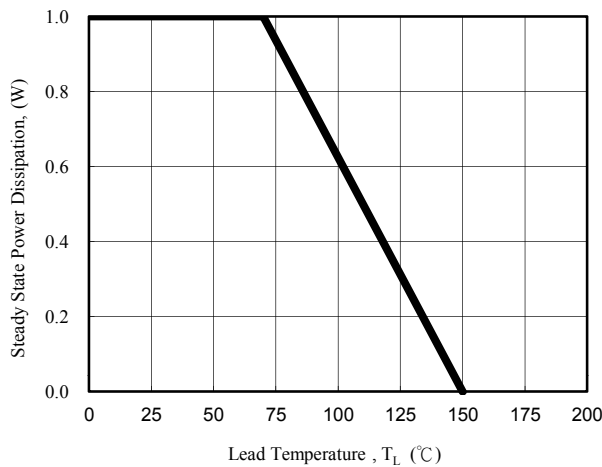

Fig. 3 - Steady State Power Derating Curve

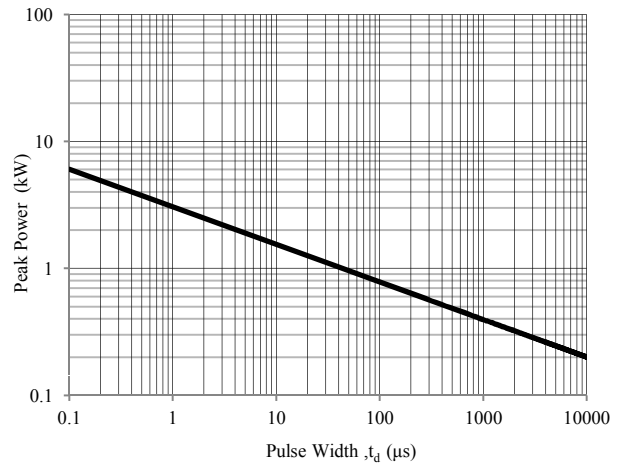

Fig. 4 - Peak Pulse Power Rating Curve

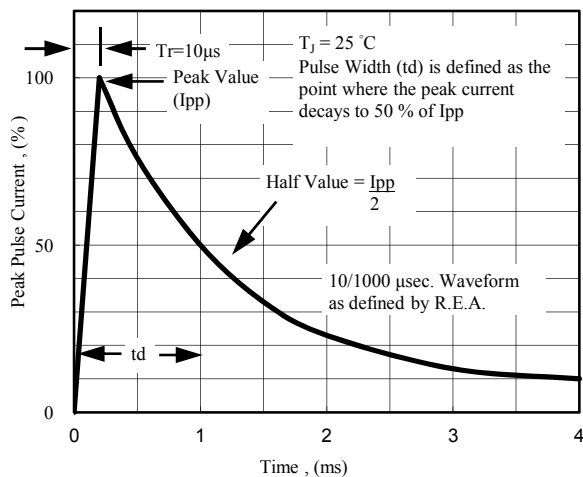

Fig. 5 - Pulse Waveform

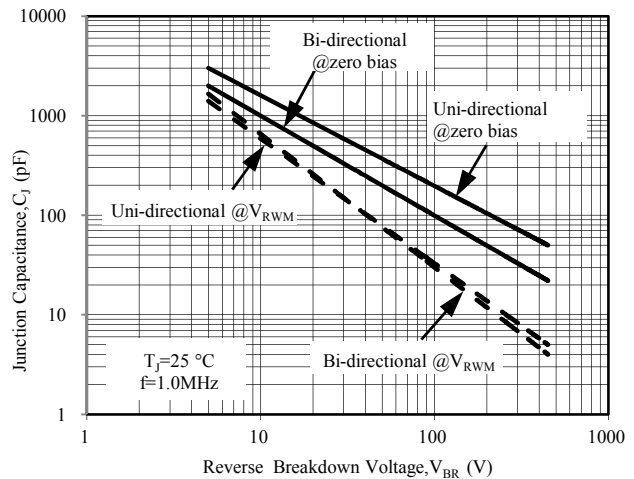
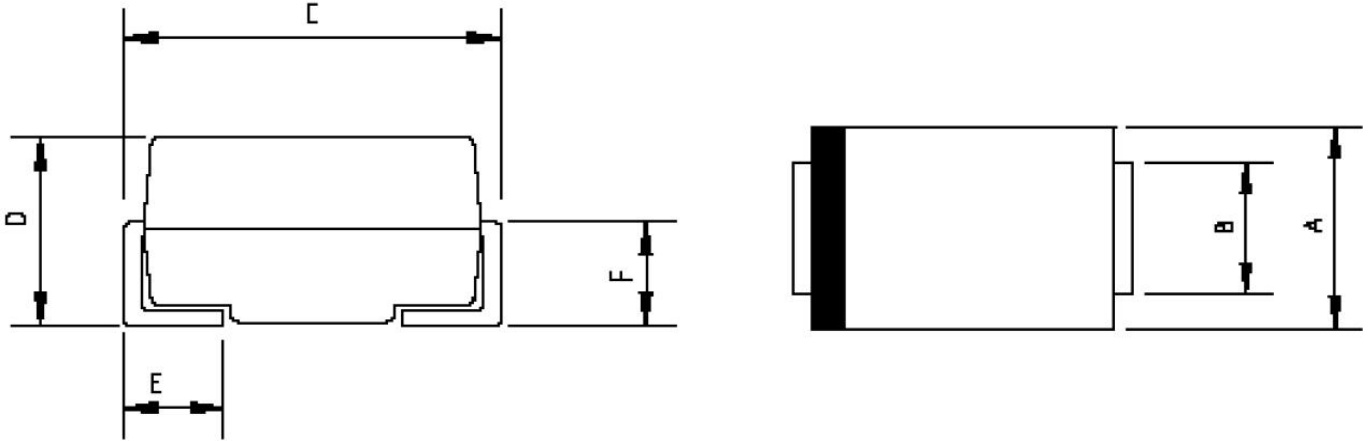

Fig. 6 - Typical Junction Capacitance

TVS DIODE

**SMA Package Outline Dimensions**



Symbol	Dimensions In Millimeters		Dimensions In Inches	
	Min.	Max.	Min.	Max.
A	2.20	2.80	0.086	0.110
B	1.30	1.70	0.051	0.067
C	4.70	5.30	0.185	0.209
D	1.70	2.55	0.067	0.100
E	0.90	1.50	0.035	0.059
F	0.90	1.50	0.035	0.059

**SMA Suggested Pad Layout**

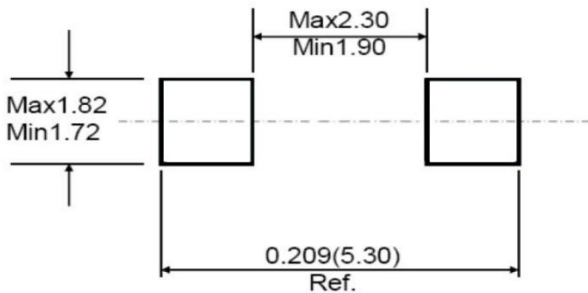

**Note:**

1. Controlling dimension: in millimeters
2. General tolerance:  $\pm 0.05\text{mm}$
3. The pad layout is for reference purposes only

TVS DIODE

**SMA Tape and Reel**

**SMA Embossed Carrier Tape**

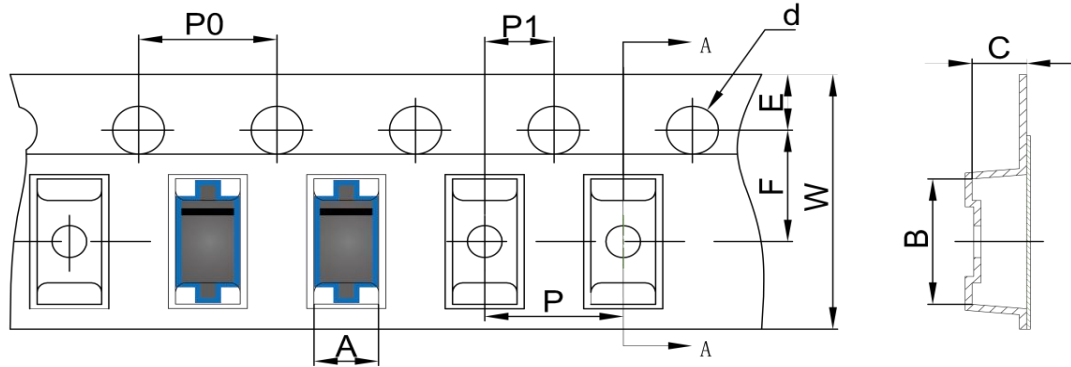

DIMENSIONS ARE IN MILLIMETER										
TYPE	A	B	C	d	E	F	P0	P	P1	W
SMA	2.89	5.35	2.68	Ø1.50	1.75	5.50	4.00	4.00	2.00	12.00
TOLERANCE	±0.1	±0.1	±0.1	±0.1	±0.1	±0.1	±0.1	±0.1	±0.1	±0.1

**SMA Tape Leader and Trailer**

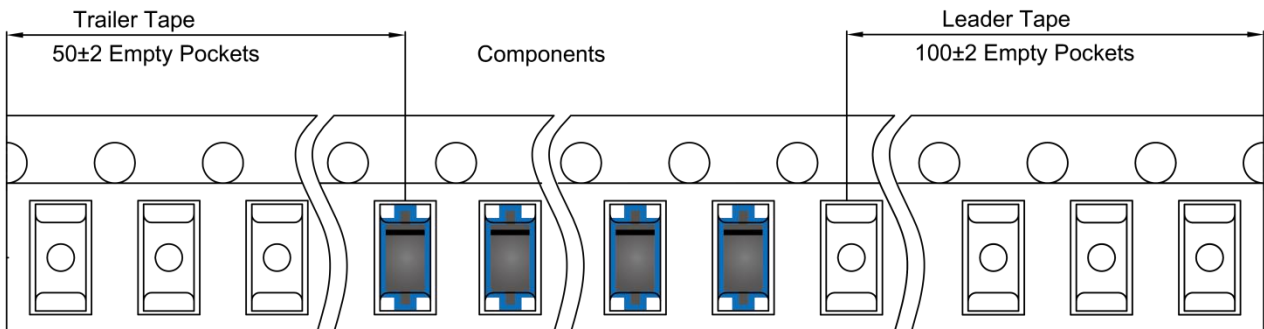

**SMA Reel**

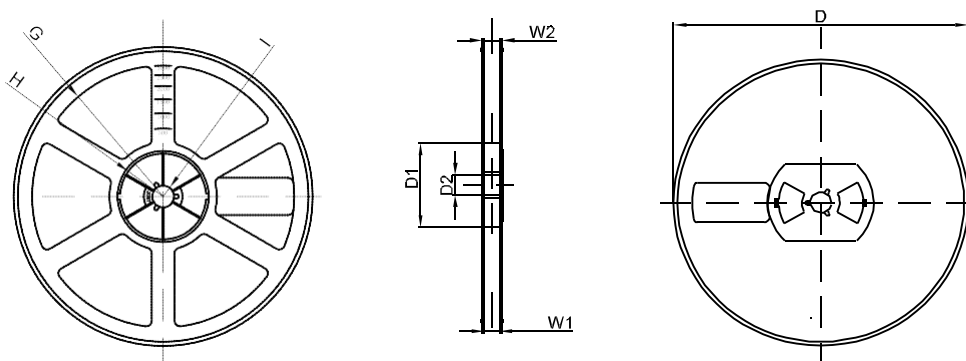

DIMENSIONS ARE IN MILLIMETER								
REEL OPTION	D	D1	D2	G	H	I	W1	W2
7" DIA	Ø178	54.40	13.00	R78	R25.60	R6.50	12.40	17.60
TOLERANCE	±2	±1	±1	±1	±1	±1	±1	±1