

# Chip Monolithic Ceramic Capacitors

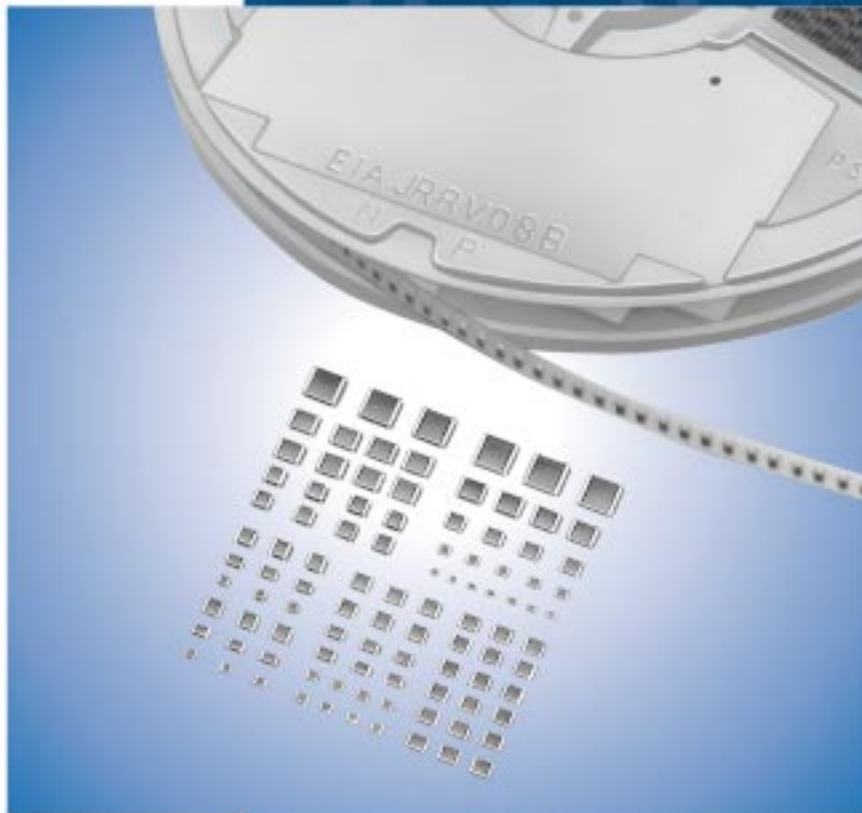

# CONTENTS

<b>Part Numbering</b>	_____	2
<b>Selection Guide</b>	_____	6
<b>1</b> for Flow/Reflow Soldering GRM15/18/21/31 Series	_____	7
<b>2</b> for Reflow Soldering GRM32/43/55 Series	_____	16
<b>3</b> Ultra-small GRM02/03 Series	_____	19
<b>4</b> Tight Tolerance GRM03/15 Series	_____	22
<b>5</b> Thin Type (Flow/Reflow)	_____	25
<b>1</b> to <b>5</b> Specifications and Test Methods	_____	27
<b>6</b> Large Capacitance Type	_____	32
<b>6</b> Specifications and Test Methods	_____	35
<b>7</b> High-Q GJM Series	_____	38
<b>8</b> Tight Tolerance High-Q GJM Series	_____	41
<b>7</b> · <b>8</b> Specifications and Test Methods	_____	44
<b>GRM Series Data</b>	_____	47
<b>9</b> Microchips GMA Series	_____	49
<b>9</b> Specifications and Test Methods	_____	50
<b>10</b> Capacitor Arrays GNM Series	_____	52
<b>10</b> Specifications and Test Methods	_____	55
<b>11</b> for Ultrasonic Sensors GRM Series	_____	61
<b>11</b> Specifications and Test Methods	_____	62
<b>12</b> Low ESL LLL/LLA/LLM Series	_____	64
<b>12</b> Specifications and Test Methods	_____	70
<b>13</b> High Frequency GQM Series	_____	72
<b>13</b> Specifications and Test Methods	_____	74
<b>14</b> High Frequency Type ERB Series	_____	77
<b>14</b> Specifications and Test Methods	_____	79
<b>ERB Series Data</b>	_____	82
<b>Package</b>	_____	84
<b>⚠ Caution</b>	_____	88

<b>Notice</b>	93
<b>Reference Data</b>	98
<b>15 Medium Voltage Low Dissipation Factor</b>	105
<b>16 Medium Voltage High Capacitance for General-Use</b>	110
<b>17 Only for Information Devices/Tip &amp; Ring</b>	114
<b>18 Only for Camera Flash Circuit</b>	118
<b>19 AC250V (r.m.s.) Type (Which Meet Japanese Law)</b>	121
<b>20 Safety Standard Recognized Type GC (UL, IEC60384-14 Class X1/Y2)</b>	125
<b>21 Safety Standard Recognized Type GD (IEC60384-14 Class Y3)</b>	126
<b>22 Safety Standard Recognized Type GF (IEC60384-14 Class Y2, X1/Y2)</b>	127
<b>23 Safety Standard Recognized Type GB (IEC60384-14 Class X2)</b>	128
<b>GA3 Series Specifications and Test Methods</b>	129
<b>GRM/GR4/GR7/GA2/GA3 Series Data (Typical Example)</b>	133
<b>Package</b>	136
<b>⚠ Caution</b>	139
<b>Notice</b>	145
<b>ISO 9001 Certifications</b>	148

● Please refer to "Specifications and Test Methods" at the end of each chapter of **15** - **19** .

## ● Part Numbering

### Chip Monolithic Ceramic Capacitors

(Part Number) 

GR	M	18	8	B1	1H	102	K	A01	K
①	②	③	④	⑤	⑥	⑦	⑧	⑨	⑩

#### ① Product ID

#### ② Series

Product ID	Code	Series
<b>GR</b>	<b>M</b>	Tin Plated Layer
	<b>4</b>	Only for Information Devices / Tip & Ring
	<b>7</b>	Only for Camera Flash Circuit
<b>ER</b>	<b>B</b>	High Frequency Type
<b>GQ</b>	<b>M</b>	High Frequency for Flow/Reflow Soldering
<b>GM</b>	<b>A</b>	Monolithic Microchip
<b>GN</b>	<b>M</b>	Capacitor Array
<b>LL</b>	<b>L</b>	Low ESL Wide Width Type
	<b>A</b>	Eight-termination Low ESL Type
	<b>M</b>	Ten-termination Low ESL Type
<b>GJ</b>	<b>M</b>	High Frequency Low Loss Type Tin Plated Type
<b>GA</b>	<b>2</b>	for AC250V (r.m.s.)
	<b>3</b>	Safety Standard Recognized Type

#### ③ Dimension (L×W)

Code	Dimension (L×W)	EIA
<b>02</b>	0.4×0.2mm	01005
<b>03</b>	0.6×0.3mm	0201
<b>05</b>	0.5×0.5mm	0202
<b>08</b>	0.8×0.8mm	0303
<b>11</b>	1.25×1.0mm	0504
<b>15</b>	1.0×0.5mm	0402
<b>18</b>	1.6×0.8mm	0603
<b>1D</b>	1.4×1.4mm	
<b>1X</b>	Depends on individual standards.	
<b>21</b>	2.0×1.25mm	0805
<b>22</b>	2.8×2.8mm	1111
<b>31</b>	3.2×1.6mm	1206
<b>32</b>	3.2×2.5mm	1210
<b>3X</b>	Depends on individual standards.	
<b>42</b>	4.5×2.0mm	1808
<b>43</b>	4.5×3.2mm	1812
<b>52</b>	5.7×2.8mm	2211
<b>55</b>	5.7×5.0mm	2220

#### ④ Dimension (T)

Code	Dimension (T)
<b>2</b>	0.2mm
<b>2</b>	2-elements (Array Type)
<b>3</b>	0.3mm
<b>4</b>	4-elements (Array Type)
<b>5</b>	0.5mm
<b>6</b>	0.6mm
<b>7</b>	0.7mm
<b>8</b>	0.8mm
<b>9</b>	0.85mm
<b>A</b>	1.0mm
<b>B</b>	1.25mm
<b>C</b>	1.6mm
<b>D</b>	2.0mm
<b>E</b>	2.5mm
<b>F</b>	3.2mm
<b>M</b>	1.15mm
<b>N</b>	1.35mm
<b>R</b>	1.8mm
<b>S</b>	2.8mm
<b>Q</b>	1.5mm
<b>X</b>	Depends on individual standards.

With the array type GNM series, "Dimension(T)" indicates the number of elements.

Continued on the following page.

Continued from the preceding page.

⑤ Temperature Characteristics

Temperature Characteristic Codes			Temperature Characteristics			Operating Temperature Range
Code	Public STD Code		Referance Temperature	Temperature Range	Capacitance Change or Temperature Coefficient	
1X	SL *1	JIS	20°C	20 to 85°C	+350 to -1000ppm/°C	-55 to 125°C
2C	CH *1	JIS	20°C	20 to 125°C	0±60ppm/°C	-55 to 125°C
2P	PH *1	JIS	20°C	20 to 85°C	-150±60ppm/°C	-25 to 85°C
2R	RH *1	JIS	20°C	20 to 85°C	-220±60ppm/°C	-25 to 85°C
2S	SH *1	JIS	20°C	20 to 85°C	-330±60ppm/°C	-25 to 85°C
2T	TH *1	JIS	20°C	20 to 85°C	-470±60ppm/°C	-25 to 85°C
3C	CJ *1	JIS	20°C	20 to 125°C	0±120ppm/°C	-55 to 125°C
3P	PJ *1	JIS	20°C	20 to 85°C	-150±120ppm/°C	-25 to 85°C
3R	RJ *1	JIS	20°C	20 to 85°C	-220±120ppm/°C	-25 to 85°C
3S	SJ *1	JIS	20°C	20 to 85°C	-330±120ppm/°C	-25 to 85°C
3T	TJ *1	JIS	20°C	20 to 85°C	-470±120ppm/°C	-25 to 85°C
3U	UJ *1	JIS	20°C	20 to 85°C	-750±120ppm/°C	-25 to 85°C
4C	CK *1	JIS	20°C	20 to 125°C	0±250ppm/°C	-55 to 125°C
5C	C0G *1	EIA	25°C	25 to 125°C	0±30ppm/°C	-55 to 125°C
5G	X8G *1	EIA	25°C	25 to 150°C	0±30ppm/°C	-55 to 150°C
6C	C0H *1	EIA	25°C	25 to 125°C	0±60ppm/°C	-55 to 125°C
6P	P2H *1	EIA	25°C	25 to 85°C	-150±60ppm/°C	-55 to 125°C
6R	R2H *1	EIA	25°C	25 to 85°C	-220±60ppm/°C	-55 to 125°C
6S	S2H *1	EIA	25°C	25 to 85°C	-330±60ppm/°C	-55 to 125°C
6T	T2H *1	EIA	25°C	25 to 85°C	-470±60ppm/°C	-55 to 125°C
7U	U2J *1	EIA	25°C	25 to 85°C	-750±120ppm/°C	-55 to 125°C
B1	B *2	JIS	20°C	-25 to 85°C	±10%	-25 to 85°C
B3	B	JIS	20°C	-25 to 85°C	±10%	-25 to 85°C
C7	X7S	EIA	25°C	-55 to 125°C	±22%	-55 to 125°C
C8	X6S	EIA	25°C	-55 to 105°C	±22%	-55 to 105°C
F1	F *2	JIS	20°C	-25 to 85°C	+30, -80%	-25 to 85°C
F5	Y5V	EIA	25°C	-30 to 85°C	+22, -82%	-30 to 85°C
L8	X8L	EIA	25°C	-55 to 150°C	+15, -40%	-55 to 150°C
R1	R *2	JIS	20°C	-55 to 125°C	±15%	-55 to 125°C
R3	R	JIS	20°C	-55 to 125°C	±15%	-55 to 125°C
R6	X5R	EIA	25°C	-55 to 85°C	±15%	-55 to 85°C
R7	X7R	EIA	25°C	-55 to 125°C	±15%	-55 to 125°C
R9	X8R	EIA	25°C	-55 to 150°C	±15%	-55 to 150°C
9E	ZLM	*3	20°C	-25 to 20°C	-4700+100/-2500ppm/°C	-25 to 85°C
				20 to 85°C	-4700+500/-1000ppm/°C	
W0	-	-	25°C	-55 to 125°C	±10% *4	-55 to 125°C
					+22, -33% *5	

\*1 Please refer to table for Capacitance Change under reference temperature.

\*2 Capacitance change is specified with 50% rated voltage applied.

\*3 Murata Temperature Characteristic Code.

\*4 Apply DC350V bias.

\*5 No DC bias.

Continued on the following page. 

☐ Continued from the preceding page.

● Capacitance Change from each temperature

JIS Code

Murata Code	Capacitance Change from 20°C (%)					
	-55°C		-25°C		-10°C	
	Max.	Min.	Max.	Min.	Max.	Min.
1X	-	-	-	-	-	-
2C	0.82	-0.45	0.49	-0.27	0.33	-0.18
2P	-	-	1.32	0.41	0.88	0.27
2R	-	-	1.70	0.72	1.13	0.48
2S	-	-	2.30	1.22	1.54	0.81
2T	-	-	3.07	1.85	2.05	1.23
3C	1.37	-0.90	0.82	-0.54	0.55	-0.36
3P	-	-	1.65	0.14	1.10	0.09
3R	-	-	2.03	0.45	1.35	0.30
3S	-	-	2.63	0.95	1.76	0.63
3T	-	-	3.40	1.58	2.27	1.05
3U	-	-	4.94	2.84	3.29	1.89
4C	2.56	-1.88	1.54	-1.13	1.02	-0.75

EIA Code

Murata Code	Capacitance Change from 25°C (%)					
	-55°C		-30°C		-10°C	
	Max.	Min.	Max.	Min.	Max.	Min.
5C/5G	0.58	-0.24	0.40	-0.17	0.25	-0.11
6C	0.87	-0.48	0.59	-0.33	0.38	-0.21
6P	2.33	0.72	1.61	0.50	1.02	0.32
6R	3.02	1.28	2.08	0.88	1.32	0.56
6S	4.09	2.16	2.81	1.49	1.79	0.95
6T	5.46	3.28	3.75	2.26	2.39	1.44
7U	8.78	5.04	6.04	3.47	3.84	2.21

⑥ Rated Voltage

Code	Rated Voltage
0G	DC4V
0J	DC6.3V
1A	DC10V
1C	DC16V
1E	DC25V
1H	DC50V
2A	DC100V
2D	DC200V
2E	DC250V
YD	DC300V
2H	DC500V
2J	DC630V
3A	DC1kV
3D	DC2kV
3F	DC3.15kV
BB	DC350V (for Camera Flash Circuit)
E2	AC250V
GB	X2; AC250V (Safety Standard Recognized Type GB)
GC	X1/Y2; AC250V (Safety Standard Recognized Type GC)
GD	Y3; AC250V (Safety Standard Recognized Type GD)
GF	Y2, X1/Y2; AC250V (Safety Standard Recognized Type GF)

⑦ Capacitance

Expressed by three figures. The unit is pico-farad (pF). The first and second figures are significant digits, and the third figure expresses the number of zeros which follow the two numbers. If there is a decimal point, it is expressed by the capital letter "R". In this case, all figures are significant digits.

Ex.)

Code	Capacitance
R50	0.5pF
1R0	1.0pF
100	10pF
103	10000pF

Continued on the following page. ☐

Continued from the preceding page.

⑧ Capacitance Tolerance

Code	Capacitance Tolerance	TC	Series	Capacitance Step	
<b>B</b>	±0.1pF	CΔ	<b>GRM/GJM</b>	≤5pF	E24 Series, 1pF
<b>C</b>	±0.25pF	CΔ-SL	<b>GRM/ERB/GQM</b>	≤5pF	* 1pF
		CΔ	<b>GJM</b>	<10pF	E24 Series, 1pF
<b>D</b>	±0.5pF	CΔ-SL	<b>GRM</b>	6.0 to 9.0pF	* 1pF
		CΔ	<b>ERB/GQM/GJM</b>	5.1 to 9.1pF	E24 Series
<b>F</b>	±1%	CΔ	<b>GRM03/15, GJM03/15</b>	5.0 to 9.9pF	0.1pF
<b>G</b>	±2%	CΔ	<b>GJM</b>	≥10pF	E12 Series
		CΔ	<b>GQM</b>	≥10pF	E24 Series
		CΔ	<b>GRM03/15, GJM03/15</b>	2.0 to 9.9pF	0.1pF
<b>J</b>	±5%	CΔ-SL	<b>GRM/GA3</b>	≥10pF	E12 Series
		CΔ	<b>ERB/GQM/GJM</b>	≥10pF	E24 Series
		CΔ	<b>GRM03/15, GJM03/15</b>	1.0 to 4.9pF	0.1pF
<b>K</b>	±10%	B, R, X7R, X5R, ZLM	<b>GRM/GR7/GA3</b>	E6 Series	
			<b>GR4</b>	E12 Series	
		CΔ	<b>GRM03/15, GJM03/15</b>	0.2 to 1.9pF	0.1pF
<b>M</b>	±20%	Z5U	<b>GRM</b>	E3 Series	
		B, R, X7R, X7S	<b>GRM/GMA/LLL/LLA/LLM</b>	E6 Series	
		X7R	<b>GA2</b>	E3 Series	
		CΔ	<b>GRM03/15, GJM03/15</b>	0.1 to 0.9pF	0.1pF
<b>Z</b>	+80%, -20%	F, Y5V	<b>GRM</b>	E3 Series	
<b>R</b>			Depends on individual standards.		

\* E24 series is also available.

⑨ Individual Specification Code

Expressed by three figures.

⑩ Packaging

Code	Packaging
<b>L</b>	ø178mm Embossed Taping
<b>D</b>	ø178mm Paper Taping
<b>K</b>	ø330mm Embossed Taping
<b>J</b>	ø330mm Paper Taping
<b>E</b>	ø178mm Special Packaging
<b>F</b>	ø330mm Special Packaging
<b>B</b>	Bulk
<b>C</b>	Bulk Case
<b>T</b>	Bulk Tray

## Selection Guide of Chip Monolithic Ceramic Capacitors

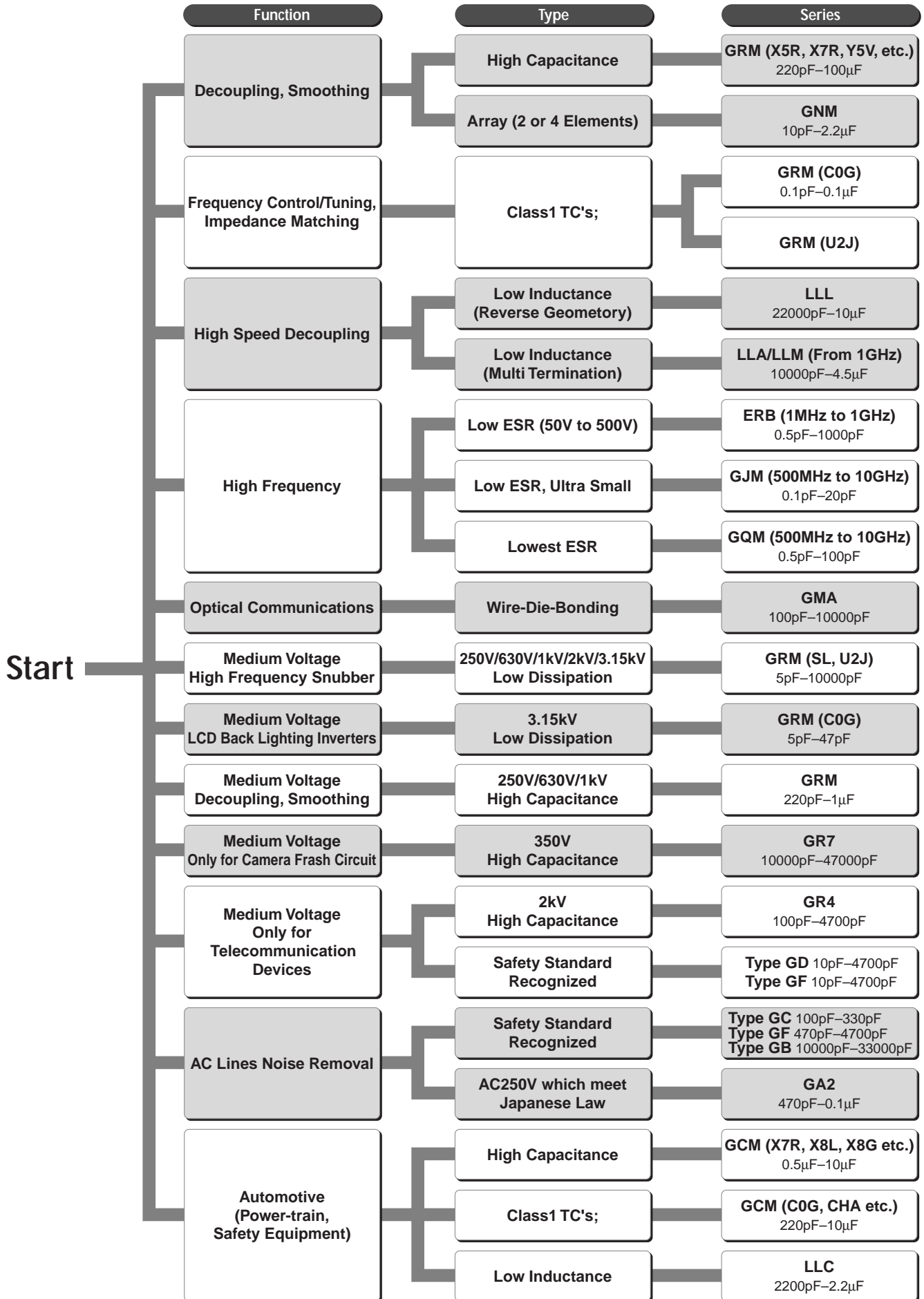



# Chip Monolithic Ceramic Capacitors



## for Flow/Reflow Soldering GRM15/18/21/31 Series

### ■ Features

1. Terminations are made of metal highly resistant to migration.
2. The GRM series is a complete line of chip ceramic capacitors in 6.3V, 10V, 16V, 25V, 50V, 100V, 200V and 500V ratings. These capacitors have temperature characteristics ranging from C0G to Y5V.
3. A wide selection of sizes is available, from the miniature LxWxT: 1.0x0.5x0.5mm to LxWxT: 3.2x1.6x1.6mm.  
 GRM18, 21 and GRM31 types are suited to flow and reflow soldering.  
 GRM15 type is applied to only reflow soldering.

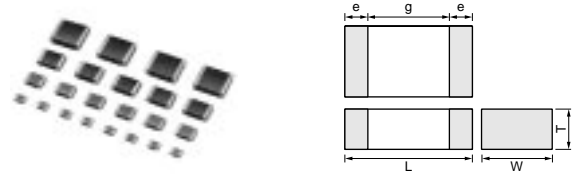

Part Number	Dimensions (mm)				
	L	W	T	e	g min.
<b>GRM155</b>	1.0 ±0.05	0.5 ±0.05	0.5 ±0.05	0.15 to 0.35	0.3
<b>GRM188*</b>	1.6 ±0.1	0.8 ±0.1	0.8 ±0.1	0.2 to 0.5	0.5
<b>GRM216</b>	2.0 ±0.1	1.25 ±0.1	0.6 ±0.1	0.2 to 0.7	0.7
<b>GRM219</b>			0.85 ±0.1		
<b>GRM21A</b>			1.0 +0/-0.2		
<b>GRM21B</b>			1.25 ±0.1		
<b>GRM316</b>	3.2 ±0.15	1.6 ±0.15	0.6 ±0.1	0.3 to 0.8	1.5
<b>GRM319</b>			0.85 ±0.1		
<b>GRM31M</b>			1.15 ±0.1		
<b>GRM31C</b>	3.2 ±0.2	1.6 ±0.2	1.6 ±0.2		

\* Bulk Case : 1.6 ±0.07(L) × 0.8 ±0.07(W) × 0.8 ±0.07(T)

### ■ Applications

General electronic equipment

## Temperature Compensating Type GRM15 Series (1.00x0.50mm) 50/25V

Part Number	GRM15							
L x W [EIA]	1.00x0.50 [0402]							
TC	C0G (5C)	P2H (6P)	R2H (6R)	S2H (6S)	SL (1X)		T2H (6T)	U2J (7U)
Rated Volt.	50 (1H)	50 (1H)	50 (1H)	50 (1H)	50 (1H)	25 (1E)	50 (1H)	50 (1H)
Capacitance (Capacitance part numbering code) and T (mm) Dimension (T Dimension part numbering code)								
0.30pF(R30)	0.50(5)							
0.40pF(R40)	0.50(5)							
0.50pF(R50)	0.50(5)							
0.60pF(R60)	0.50(5)							
0.70pF(R70)	0.50(5)							
0.75pF(R75)	0.50(5)							
0.80pF(R80)	0.50(5)							
0.90pF(R90)	0.50(5)							
1.0pF(1R0)	0.50(5)							
1.1pF(1R1)	0.50(5)							
1.2pF(1R2)	0.50(5)							
1.3pF(1R3)	0.50(5)							
1.4pF(1R4)	0.50(5)							
1.5pF(1R5)	0.50(5)							
1.6pF(1R6)	0.50(5)							
1.7pF(1R7)	0.50(5)							
1.8pF(1R8)	0.50(5)							
1.9pF(1R9)	0.50(5)							
2.0pF(2R0)	0.50(5)							
2.1pF(2R1)	0.50(5)							
2.2pF(2R2)	0.50(5)							
2.3pF(2R3)	0.50(5)							
2.4pF(2R4)	0.50(5)							
2.5pF(2R5)	0.50(5)							
2.6pF(2R6)	0.50(5)							

Continued on the following page.

1

 Continued from the preceding page.

Part Number	GRM15							
L x W [EIA]	1.00x0.50 [0402]							
TC	COG (5C)	P2H (6P)	R2H (6R)	S2H (6S)	SL (1X)		T2H (6T)	U2J (7U)
Rated Volt.	50 (1H)	50 (1H)	50 (1H)	50 (1H)	50 (1H)	25 (1E)	50 (1H)	50 (1H)
Capacitance (Capacitance part numbering code) and T (mm) Dimension (T Dimension part numbering code)								
2.7pF(2R7)	0.50(5)							
2.8pF(2R8)	0.50(5)							
2.9pF(2R9)	0.50(5)							
3.0pF(3R0)	0.50(5)	0.50(5)	0.50(5)	0.50(5)			0.50(5)	0.50(5)
3.1pF(3R1)	0.50(5)							
3.2pF(3R2)	0.50(5)							
3.3pF(3R3)	0.50(5)							
3.4pF(3R4)	0.50(5)							
3.5pF(3R5)	0.50(5)							
3.6pF(3R6)	0.50(5)							
3.7pF(3R7)	0.50(5)							
3.8pF(3R8)	0.50(5)							
3.9pF(3R9)	0.50(5)							
4.0pF(4R0)	0.50(5)	0.50(5)	0.50(5)	0.50(5)			0.50(5)	0.50(5)
4.1pF(4R1)	0.50(5)							
4.2pF(4R2)	0.50(5)							
4.3pF(4R3)	0.50(5)							
4.4pF(4R4)	0.50(5)							
4.5pF(4R5)	0.50(5)							
4.6pF(4R6)	0.50(5)							
4.7pF(4R7)	0.50(5)							
4.8pF(4R8)	0.50(5)							
4.9pF(4R9)	0.50(5)							
5.0pF(5R0)	0.50(5)	0.50(5)	0.50(5)	0.50(5)			0.50(5)	0.50(5)
5.1pF(5R1)	0.50(5)							
5.2pF(5R2)	0.50(5)							
5.3pF(5R3)	0.50(5)							
5.4pF(5R4)	0.50(5)							
5.5pF(5R5)	0.50(5)							
5.6pF(5R6)	0.50(5)							
5.7pF(5R7)	0.50(5)							
5.8pF(5R8)	0.50(5)							
5.9pF(5R9)	0.50(5)							
6.0pF(6R0)	0.50(5)	0.50(5)	0.50(5)	0.50(5)			0.50(5)	0.50(5)
6.1pF(6R1)	0.50(5)							
6.2pF(6R2)	0.50(5)							
6.3pF(6R3)	0.50(5)							
6.4pF(6R4)	0.50(5)							
6.5pF(6R5)	0.50(5)							
6.6pF(6R6)	0.50(5)							
6.7pF(6R7)	0.50(5)							
6.8pF(6R8)	0.50(5)							
6.9pF(6R9)	0.50(5)							
7.0pF(7R0)	0.50(5)	0.50(5)	0.50(5)	0.50(5)			0.50(5)	0.50(5)
7.1pF(7R1)	0.50(5)							
7.2pF(7R2)	0.50(5)							
7.3pF(7R3)	0.50(5)							
7.4pF(7R4)	0.50(5)							
7.5pF(7R5)	0.50(5)							
7.6pF(7R6)	0.50(5)							
7.7pF(7R7)	0.50(5)							
7.8pF(7R8)	0.50(5)							

Continued on the following page. 

Continued from the preceding page.

Part Number	GRM15							
L x W [EIA]	1.00x0.50 [0402]							
TC	COG (5C)	P2H (6P)	R2H (6R)	S2H (6S)	SL (1X)		T2H (6T)	U2J (7U)
Rated Volt.	50 (1H)	50 (1H)	50 (1H)	50 (1H)	50 (1H)	25 (1E)	50 (1H)	50 (1H)
Capacitance (Capacitance part numbering code) and T (mm) Dimension (T Dimension part numbering code)								
7.9pF(7R9)	0.50(5)							
8.0pF(8R0)	0.50(5)	0.50(5)	0.50(5)	0.50(5)			0.50(5)	0.50(5)
8.1pF(8R1)	0.50(5)							
8.2pF(8R2)	0.50(5)							
8.3pF(8R3)	0.50(5)							
8.4pF(8R4)	0.50(5)							
8.5pF(8R5)	0.50(5)							
8.6pF(8R6)	0.50(5)							
8.7pF(8R7)	0.50(5)							
8.8pF(8R8)	0.50(5)							
8.9pF(8R9)	0.50(5)							
9.0pF(9R0)	0.50(5)	0.50(5)	0.50(5)	0.50(5)			0.50(5)	0.50(5)
9.1pF(9R1)	0.50(5)							
9.2pF(9R2)	0.50(5)							
9.3pF(9R3)	0.50(5)							
9.4pF(9R4)	0.50(5)							
9.5pF(9R5)	0.50(5)							
9.6pF(9R6)	0.50(5)							
9.7pF(9R7)	0.50(5)							
9.8pF(9R8)	0.50(5)							
9.9pF(9R9)	0.50(5)							
10pF(100)	0.50(5)	0.50(5)	0.50(5)	0.50(5)			0.50(5)	0.50(5)
12pF(120)	0.50(5)	0.50(5)	0.50(5)	0.50(5)			0.50(5)	0.50(5)
15pF(150)	0.50(5)	0.50(5)	0.50(5)	0.50(5)			0.50(5)	0.50(5)
18pF(180)	0.50(5)	0.50(5)	0.50(5)	0.50(5)			0.50(5)	0.50(5)
22pF(220)	0.50(5)	0.50(5)	0.50(5)	0.50(5)			0.50(5)	0.50(5)
27pF(270)	0.50(5)	0.50(5)	0.50(5)	0.50(5)			0.50(5)	0.50(5)
33pF(330)	0.50(5)		0.50(5)	0.50(5)			0.50(5)	0.50(5)
39pF(390)	0.50(5)			0.50(5)			0.50(5)	0.50(5)
47pF(470)	0.50(5)				0.50(5)		0.50(5)	0.50(5)
56pF(560)	0.50(5)				0.50(5)		0.50(5)	0.50(5)
68pF(680)	0.50(5)				0.50(5)		0.50(5)	0.50(5)
82pF(820)	0.50(5)				0.50(5)		0.50(5)	0.50(5)
100pF(101)	0.50(5)				0.50(5)		0.50(5)	0.50(5)
120pF(121)	0.50(5)				0.50(5)			0.50(5)
150pF(151)	0.50(5)				0.50(5)			0.50(5)
180pF(181)	0.50(5)				0.50(5)			0.50(5)
220pF(221)	0.50(5)					0.50(5)		
270pF(271)	0.50(5)					0.50(5)		
330pF(331)	0.50(5)					0.50(5)		
390pF(391)	0.50(5)					0.50(5)		
470pF(471)	0.50(5)							
560pF(561)	0.50(5)							
680pF(681)	0.50(5)							
820pF(821)	0.50(5)							
1000pF(102)	0.50(5)							

The part numbering code is shown in ( ).  
 Dimensions are shown in mm and Rated Voltage in Vdc.

## Temperature Compensating Type GRM18 Series (1.60x0.80mm) 200/100/50/25V

Part Number	GRM18										
L x W [EIA]	1.60x0.80 [0603]										
TC	C0G (5C)			P2H (6P)	R2H (6R)	S2H (6S)	SL (1X)			T2H (6T)	U2J (7U)
Rated Volt.	200 (2D)	100 (2A)	50 (1H)	50 (1H)	50 (1H)	50 (1H)	200 (2D)	100 (2A)	50 (1H)	50 (1H)	50 (1H)
Capacitance (Capacitance part numbering code) and T (mm) Dimension (T Dimension part numbering code)											
0.50pF( <b>R50</b> )	0.80(8)	0.80(8)	0.80(8)								
0.75pF( <b>R75</b> )	0.80(8)	0.80(8)	0.80(8)								
1.0pF( <b>1R0</b> )	0.80(8)	0.80(8)	0.80(8)								
2.0pF( <b>2R0</b> )	0.80(8)	0.80(8)	0.80(8)								
3.0pF( <b>3R0</b> )	0.80(8)	0.80(8)	0.80(8)	0.80(8)	0.80(8)	0.80(8)				0.80(8)	0.80(8)
4.0pF( <b>4R0</b> )	0.80(8)	0.80(8)	0.80(8)	0.80(8)	0.80(8)	0.80(8)				0.80(8)	0.80(8)
5.0pF( <b>5R0</b> )	0.80(8)	0.80(8)	0.80(8)	0.80(8)	0.80(8)	0.80(8)				0.80(8)	0.80(8)
6.0pF( <b>6R0</b> )	0.80(8)	0.80(8)	0.80(8)	0.80(8)	0.80(8)	0.80(8)				0.80(8)	0.80(8)
7.0pF( <b>7R0</b> )	0.80(8)	0.80(8)	0.80(8)	0.80(8)	0.80(8)	0.80(8)				0.80(8)	0.80(8)
8.0pF( <b>8R0</b> )	0.80(8)	0.80(8)	0.80(8)	0.80(8)	0.80(8)	0.80(8)				0.80(8)	0.80(8)
9.0pF( <b>9R0</b> )	0.80(8)	0.80(8)	0.80(8)	0.80(8)	0.80(8)	0.80(8)				0.80(8)	0.80(8)
10pF( <b>100</b> )	0.80(8)	0.80(8)	0.80(8)	0.80(8)	0.80(8)	0.80(8)				0.80(8)	0.80(8)
12pF( <b>120</b> )		0.80(8)	0.80(8)	0.80(8)	0.80(8)	0.80(8)	0.80(8)			0.80(8)	0.80(8)
15pF( <b>150</b> )		0.80(8)	0.80(8)	0.80(8)	0.80(8)	0.80(8)	0.80(8)			0.80(8)	0.80(8)
18pF( <b>180</b> )		0.80(8)	0.80(8)	0.80(8)	0.80(8)	0.80(8)	0.80(8)			0.80(8)	0.80(8)
22pF( <b>220</b> )		0.80(8)	0.80(8)	0.80(8)	0.80(8)	0.80(8)	0.80(8)			0.80(8)	0.80(8)
27pF( <b>270</b> )		0.80(8)	0.80(8)	0.80(8)	0.80(8)	0.80(8)	0.80(8)			0.80(8)	0.80(8)
33pF( <b>330</b> )		0.80(8)	0.80(8)	0.80(8)	0.80(8)	0.80(8)	0.80(8)			0.80(8)	0.80(8)
39pF( <b>390</b> )		0.80(8)	0.80(8)	0.80(8)	0.80(8)	0.80(8)	0.80(8)			0.80(8)	0.80(8)
47pF( <b>470</b> )		0.80(8)	0.80(8)	0.80(8)	0.80(8)	0.80(8)	0.80(8)			0.80(8)	0.80(8)
56pF( <b>560</b> )		0.80(8)	0.80(8)	0.80(8)	0.80(8)	0.80(8)	0.80(8)			0.80(8)	0.80(8)
68pF( <b>680</b> )		0.80(8)	0.80(8)	0.80(8)	0.80(8)	0.80(8)	0.80(8)		0.80(8)	0.80(8)	0.80(8)
82pF( <b>820</b> )		0.80(8)	0.80(8)	0.80(8)	0.80(8)	0.80(8)	0.80(8)		0.80(8)	0.80(8)	0.80(8)
100pF( <b>101</b> )		0.80(8)	0.80(8)	0.80(8)	0.80(8)	0.80(8)	0.80(8)		0.80(8)	0.80(8)	0.80(8)
120pF( <b>121</b> )		0.80(8)	0.80(8)	0.80(8)	0.80(8)	0.80(8)		0.80(8)	0.80(8)	0.80(8)	0.80(8)
150pF( <b>151</b> )		0.80(8)	0.80(8)	0.80(8)	0.80(8)	0.80(8)		0.80(8)	0.80(8)	0.80(8)	0.80(8)
180pF( <b>181</b> )		0.80(8)	0.80(8)		0.80(8)	0.80(8)		0.80(8)	0.80(8)	0.80(8)	0.80(8)
220pF( <b>221</b> )		0.80(8)	0.80(8)			0.80(8)		0.80(8)	0.80(8)	0.80(8)	0.80(8)
270pF( <b>271</b> )		0.80(8)	0.80(8)					0.80(8)	0.80(8)	0.80(8)	0.80(8)
330pF( <b>331</b> )		0.80(8)	0.80(8)					0.80(8)	0.80(8)	0.80(8)	0.80(8)
390pF( <b>391</b> )		0.80(8)	0.80(8)					0.80(8)	0.80(8)	0.80(8)	0.80(8)
470pF( <b>471</b> )		0.80(8)	0.80(8)						0.80(8)	0.80(8)	0.80(8)
560pF( <b>561</b> )		0.80(8)	0.80(8)						0.80(8)		0.80(8)
680pF( <b>681</b> )		0.80(8)	0.80(8)						0.80(8)		0.80(8)
820pF( <b>821</b> )		0.80(8)	0.80(8)								
1000pF( <b>102</b> )		0.80(8)	0.80(8)						0.80(8)		0.80(8)
1200pF( <b>122</b> )			0.80(8)						0.80(8)		0.80(8)
1500pF( <b>152</b> )			0.80(8)						0.80(8)		0.80(8)
1800pF( <b>182</b> )			0.80(8)						0.80(8)		0.80(8)
2200pF( <b>222</b> )			0.80(8)						0.80(8)		0.80(8)
2700pF( <b>272</b> )			0.80(8)						0.80(8)		0.80(8)
3300pF( <b>332</b> )									0.80(8)		0.80(8)
3900pF( <b>392</b> )									0.80(8)		0.80(8)
4700pF( <b>472</b> )									0.80(8)		0.80(8)
5600pF( <b>562</b> )									0.80(8)		0.80(8)
6800pF( <b>682</b> )									0.80(8)		0.80(8)
8200pF( <b>822</b> )									0.80(8)		0.80(8)
10000pF( <b>103</b> )									0.80(8)		0.80(8)

The part numbering code is shown in ( ).  
 Dimensions are shown in mm and Rated Voltage in Vdc.

## Temperature Compensating Type GRM21 Series (2.00x1.25mm) 200/100/50/25V

Part Number	GRM21										
L x W [EIA]	2.00x1.25 [0805]										
TC	C0G (5C)			P2H (6P)	R2H (6R)	S2H (6S)	SL (1X)			T2H (6T)	U2J (7U)
Rated Volt.	200 (2D)	100 (2A)	50 (1H)	50 (1H)	50 (1H)	50 (1H)	200 (2D)	100 (2A)	50 (1H)	50 (1H)	50 (1H)
Capacitance (Capacitance part numbering code) and T (mm) Dimension (T Dimension part numbering code)											
12pF(120)	0.85(9)	0.85(9)									
15pF(150)	0.85(9)	0.85(9)									
18pF(180)	0.85(9)	0.85(9)									
22pF(220)	0.85(9)	0.85(9)									
27pF(270)	0.85(9)	0.85(9)									
33pF(330)	0.85(9)	0.85(9)									
39pF(390)	0.85(9)	0.85(9)									
47pF(470)	0.85(9)	0.85(9)									
56pF(560)	0.85(9)	0.85(9)									
68pF(680)	1.25(B)										
82pF(820)	1.25(B)										
100pF(101)	1.25(B)										
120pF(121)	1.25(B)						0.85(9)				
150pF(151)	1.25(B)						1.25(B)				
180pF(181)	1.25(B)			0.85(9)			1.25(B)				
220pF(221)	1.25(B)			0.85(9)	0.85(9)		1.25(B)				
270pF(271)				0.85(9)	0.85(9)	0.85(9)	1.25(B)				
330pF(331)				0.85(9)	0.85(9)	0.85(9)	1.25(B)				
390pF(391)				1.25(B)	0.85(9)	0.85(9)	1.25(B)				
470pF(471)				1.25(B)	0.85(9)	0.85(9)	1.25(B)	0.85(9)			
560pF(561)				1.25(B)	1.25(B)	1.25(B)		0.85(9)		1.25(B)	
680pF(681)		0.85(9)			1.25(B)	1.25(B)		0.85(9)		1.25(B)	
820pF(821)		0.85(9)				1.25(B)		1.25(B)	0.60(6)	1.25(B)	0.60(6)
1000pF(102)		0.85(9)						1.25(B)	0.60(6)	1.25(B)	0.60(6)
1200pF(122)		0.85(9)	0.60(6)					1.25(B)	0.60(6)	1.25(B)	0.60(6)
1500pF(152)		0.85(9)	0.60(6)					1.25(B)	0.85(9)	1.25(B)	0.85(9)
1800pF(182)			0.60(6)					1.25(B)	0.85(9)	1.25(B)	0.85(9)
2200pF(222)			0.60(6)						0.85(9)		0.85(9)
2700pF(272)			0.60(6)						1.25(B)		1.25(B)
3300pF(332)			0.60(6)						1.25(B)		1.25(B)
3900pF(392)			0.60(6)								
4700pF(472)			0.60(6)								
5600pF(562)			0.85(9)								
6800pF(682)			0.85(9)								
8200pF(822)			0.85(9)								
10000pF(103)			0.85(9)						0.60(6)		0.60(6)
12000pF(123)			0.85(9)						0.60(6)		0.60(6)
15000pF(153)			0.85(9)						0.60(6)		0.60(6)
18000pF(183)			1.25(B)						0.60(6)		0.60(6)
22000pF(223)			1.25(B)						0.85(9)		0.85(9)
27000pF(273)									0.85(9)		0.85(9)
33000pF(333)									1.00(A)		1.00(A)
39000pF(393)									1.25(B)		1.25(B)
47000pF(473)									1.25(B)		1.25(B)

The part numbering code is shown in ( ).  
 Dimensions are shown in mm and Rated Voltage in Vdc.

## Temperature Compensating Type GRM31 Series (3.20x1.60mm) 500/200/100/50/25V

Part Number	GRM31													
L x W [EIA]	3.20x1.60 [1206]													
TC	C0G (5C)					C0H (6C)	P2H (6P)	R2H (6R)	S2H (6S)	SL (1X)			T2H (6T)	U2J (7U)
Rated Volt.	500 (2H)	200 (2D)	100 (2A)	50 (1H)	25 (1E)	25 (1E)	50 (1H)	50 (1H)	50 (1H)	200 (2D)	100 (2A)	50 (1H)	50 (1H)	50 (1H)
Capacitance (Capacitance part numbering code) and T (mm) Dimension (T Dimension part numbering code)														
1.0pF(1R0)	1.15(M)													
2.0pF(2R0)	1.15(M)													
3.0pF(3R0)	1.15(M)													
4.0pF(4R0)	1.15(M)													
5.0pF(5R0)	1.15(M)													
6.0pF(6R0)	1.15(M)													
7.0pF(7R0)	1.15(M)													
8.0pF(8R0)	1.15(M)													
9.0pF(9R0)	1.15(M)													
10pF(100)	1.15(M)													
12pF(120)	1.15(M)													
15pF(150)	1.15(M)													
18pF(180)	1.15(M)													
22pF(220)	1.15(M)													
27pF(270)	1.15(M)													
33pF(330)	1.15(M)													
39pF(390)	1.15(M)													
47pF(470)	1.15(M)													
56pF(560)	1.15(M)													
68pF(680)	1.15(M)													
82pF(820)	1.15(M)													
270pF(271)		1.15(M)												
330pF(331)		1.15(M)												
390pF(391)		1.15(M)												
470pF(471)		1.15(M)									0.85(9)			
560pF(561)									1.15(M)	0.85(9)				
680pF(681)							0.85(9)			1.15(M)	0.85(9)			
820pF(821)			0.85(9)				0.85(9)	0.85(9)		1.15(M)	0.85(9)			
1000pF(102)			0.85(9)					1.15(M)	1.15(M)	0.85(9)	1.15(M)	0.85(9)		
1200pF(122)			0.85(9)					1.15(M)	1.15(M)	1.15(M)	1.15(M)	0.85(9)		
1500pF(152)			0.85(9)					1.15(M)	1.15(M)	1.15(M)		0.85(9)		
1800pF(182)			0.85(9)							1.15(M)		0.85(9)		
2200pF(222)			0.85(9)								1.15(M)		1.15(M)	
2700pF(272)			0.85(9)								1.15(M)		1.15(M)	
3300pF(332)			0.85(9)	0.85(9)							1.15(M)		1.15(M)	
3900pF(392)			0.85(9)	0.85(9)							1.15(M)	0.85(9)	1.15(M)	0.85(9)
4700pF(472)			0.85(9)	0.85(9)							1.15(M)	0.85(9)		0.85(9)
5600pF(562)			0.85(9)	0.85(9)								0.85(9)		0.85(9)
6800pF(682)				0.85(9)	0.85(9)	0.85(9)						1.15(M)		1.15(M)
8200pF(822)				0.85(9)	1.15(M)	1.15(M)						1.15(M)		1.15(M)
10000pF(103)				0.85(9)	0.85(9)									
12000pF(123)				0.85(9)										
15000pF(153)				0.85(9)										
18000pF(183)				0.85(9)										
22000pF(223)				0.85(9)										
27000pF(273)				0.85(9)										
33000pF(333)				0.85(9)										
39000pF(393)				1.15(M)										
47000pF(473)				1.15(M)										

Continued on the following page.

Continued from the preceding page.

Part Number	GRM31													
L x W [EIA]	3.20x1.60 [1206]													
TC	COG (5C)					COH (6C)	P2H (6P)	R2H (6R)	S2H (6S)	SL (1X)			T2H (6T)	U2J (7U)
Rated Volt.	500 (2H)	200 (2D)	100 (2A)	50 (1H)	25 (1E)	25 (1E)	50 (1H)	50 (1H)	50 (1H)	200 (2D)	100 (2A)	50 (1H)	50 (1H)	50 (1H)
Capacitance (Capacitance part numbering code) and T (mm) Dimension (T Dimension part numbering code)														
56000pF(563)				1.60(C)									0.85(9)	0.85(9)
68000pF(683)				1.60(C)									1.15(M)	1.15(M)
82000pF(823)				1.60(C)									1.15(M)	1.15(M)
0.10μF(104)					1.60(C)								1.15(M)	1.15(M)

The part numbering code is shown in ( ).  
 Dimensions are shown in mm and Rated Voltage in Vdc.

### High Dielectric Constant Type X5R (R6) Characteristics

TC	X5R (R6)									
Part Number	GRM15			GRM18			GRM21		GRM31	
L x W [EIA]	1.00x0.50 [0402]			1.60x0.80 [0603]			2.00x1.25 [0805]		3.20x1.60 [1206]	
Rated Volt.	16 (1C)	10 (1A)	25 (1E)	10 (1A)	6.3 (0J)	10 (1A)	6.3 (0J)	16 (1C)	10 (1A)	6.3 (0J)
Capacitance (Capacitance part numbering code) and T (mm) Dimension (T Dimension part numbering code)										
68000pF(683)		0.50(5)								
0.10μF(104)	0.50(5)	0.50(5)								
0.22μF(224)			0.80(8)							
0.33μF(334)				0.80(8)			0.60(6)			
0.47μF(474)				0.80(8)						
0.68μF(684)				0.80(8)						
1.0μF(105)				0.80(8)	0.80(8)	0.85(9)			0.85(9)	
1.5μF(155)							0.85(9)			
2.2μF(225)							1.25(B)	1.25(B)	0.85(9)	
3.3μF(335)								1.25(B)	1.30(X)	
4.7μF(475)								1.25(B)	1.60(C)	1.15(M)
10μF(106)									1.60(C)	1.60(C)

The part numbering code is shown in each ( ).  
 3.3μF and 4.7μF, 6.3V rated are GRM21 series of L: 2±0.15, W: 1.25±0.15, T: 1.25±0.15.  
 T: 1.15±0.1mm is also available for GRM31 1.0μF for 16V.  
 L: 3.2±0.2, W: 1.6±0.2 for GRM31 16V 1.0μF type. Also L: 3.2±0.2, W: 1.6±0.2, T: 1.15±0.15 for GRM31 16V 1.5μF and 2.2μF type.  
 Dimensions are shown in mm and Rated Voltage in Vdc.

### High Dielectric Constant Type X7R (R7) Characteristics

TC	X7R (R7)																			
Part Number	GRM15					GRM18					GRM21					GRM31				
L x W [EIA]	1.00x0.50 [0402]					1.60x0.80 [0603]					2.00x1.25 [0805]					3.20x1.60 [1206]				
Rated Volt.	50 (1H)	25 (1E)	16 (1C)	10 (1A)	100 (2A)	50 (1H)	25 (1E)	16 (1C)	10 (1A)	100 (2A)	50 (1H)	25 (1E)	16 (1C)	10 (1A)	6.3 (0J)	100 (2A)	50 (1H)	25 (1E)	16 (1C)	10 (1A)
Capacitance (Capacitance part numbering code) and T (mm) Dimension (T Dimension part numbering code)																				
220pF (221)	0.50 (5)				0.80 (8)	0.80 (8)														
330pF (331)	0.50 (5)				0.80 (8)	0.80 (8)														
470pF (471)	0.50 (5)				0.80 (8)	0.80 (8)														
680pF (681)	0.50 (5)				0.80 (8)	0.80 (8)														

Continued on the following page.

Continued from the preceding page.

TC	X7R (R7)																			
Part Number	GRM15				GRM18				GRM21						GRM31					
L x W [EIA]	1.00x0.50 [0402]				1.60x0.80 [0603]				2.00x1.25 [0805]						3.20x1.60 [1206]					
Rated Volt.	50 (1H)	25 (1E)	16 (1C)	10 (1A)	100 (2A)	50 (1H)	25 (1E)	16 (1C)	10 (1A)	100 (2A)	50 (1H)	25 (1E)	16 (1C)	10 (1A)	6.3 (0J)	100 (2A)	50 (1H)	25 (1E)	16 (1C)	10 (1A)
Capacitance (Capacitance part numbering code) and T (mm) Dimension (T Dimension part numbering code)																				
1000pF (102)	0.50 (5)				0.80 (8)	0.80 (8)														
1500pF (152)	0.50 (5)				0.80 (8)	0.80 (8)														
2200pF (222)	0.50 (5)				0.80 (8)	0.80 (8)														
3300pF (332)	0.50 (5)				0.80 (8)	0.80 (8)														
4700pF (472)	0.50 (5)					0.80 (8)				0.85 (9)										
6800pF (682)		0.50 (5)				0.80 (8)				0.85 (9)										
10000pF (103)		0.50 (5)				0.80 (8)				1.25 (B)										
15000pF (153)		0.50 (5)	0.50 (5)			0.80 (8)				1.25 (B)										
22000pF (223)		0.50 (5)	0.50 (5)			0.80 (8)				1.25 (B)										
33000pF (333)		0.50 (5)	0.50 (5)	0.50 (5)		0.80 (8)	0.80 (8)			1.25 (B)	0.85 (9)					1.15 (M)				
47000pF (473)		0.50 (5)		0.50 (5)		0.80 (8)	0.80 (8)			1.25 (B)	1.25 (B)					1.15 (M)				
68000pF (683)			0.50 (5)			0.80 (8)	0.80 (8)				1.25 (B)					1.15 (M)				
0.10μF (104)			0.50 (5)	0.50 (5)		0.80 (8)	0.80 (8)	0.80 (8)			1.25 (B)	1.25 (B)								
0.15μF (154)							0.80 (8)	0.80 (8)	0.80 (8)		1.25 (B)	1.25 (B)								
0.22μF (224)							0.80 (8)	0.80 (8)	0.80 (8)		1.25 (B)	0.85 (9)								
0.33μF (334)								0.80 (8)			0.85 (9)	1.25 (B)		0.60 (6)			0.85 (9)			
0.47μF (474)									0.80 (8)		1.25 (B)	0.85 (9)	0.85 (9)				1.15 (M)		0.85 (9)	
0.68μF (684)													0.85 (9)					0.85 (9)		
1.0μF (105)												1.25 (B)	1.25 (B)				1.15 (M)	1.15 (M)	0.85 (9)	0.85 (9)
1.5μF (155)												1.25 (B)					1.60 (C)		1.15 (M)	
2.2μF (225)														1.25 (B)	1.25 (B)		1.60 (C)	1.15 (M)	1.15 (M)	1.15 (M)
3.3μF (335)																		1.60 (C)	1.60 (C)	
4.7μF (475)																		1.60 (C)	1.60 (C)	1.60 (C)
10μF (106)																				1.60 (C)

The part numbering code is shown in each ( ).

The tolerance will be changed to L: 3.2±0.2, W: 1.6±0.2 for GRM31 16V 1.0μF type. Also L: 3.2±0.2, W: 1.6±0.2, T: 1.15±0.15 for GRM31 16V 1.5μF and 2.2μF type.

Dimensions are shown in mm and Rated Voltage in Vdc.



## High Dielectric Constant Type Y5V (F5) Characteristics

TC	Y5V (F5)																	
Part Number	GRM15				GRM18				GRM21				GRM31					
L x W [EIA]	1.00x0.50 [0402]				1.60x0.80 [0603]				2.00x1.25 [0805]				3.20x1.60 [1206]					
Rated Volt.	50 (1H)	25 (1E)	16 (1C)	10 (1A)	100 (2A)	50 (1H)	25 (1E)	16 (1C)	10 (1A)	50 (1H)	25 (1E)	16 (1C)	10 (1A)	50 (1H)	25 (1E)	16 (1C)	10 (1A)	6.3 (0J)
Capacitance (Capacitance part numbering code) and T (mm) Dimension (T Dimension part numbering code)																		
2200pF (222)	0.50 (5)																	
4700pF (472)	0.50 (5)				0.80 (8)													
10000pF (103)	0.50 (5)				0.80 (8)													
22000pF (223)		0.50 (5)			0.80 (8)													
47000pF (473)		0.50 (5)	0.50 (5)		0.80 (8)													
0.10μF (104)		0.50 (5)	0.50 (5)		0.80 (8)	0.80 (8)				0.85 (9)								
0.22μF (224)			0.50 (5)		0.80 (8)		0.80 (8)			1.25 (B)	0.85 (9)							
0.47μF (474)			0.50 (5)	0.50 (5)		0.80 (8)	0.80 (8)	0.80 (8)	0.85 (9)	1.25 (B)				1.15 (M)				
1.0μF (105)							0.80 (8)	0.80 (8)	0.85 (9)	0.85 (9)	0.85 (9)	0.85 (9)			1.15 (M)	0.85 (9)		
2.2μF (225)											1.25 (B)	1.25 (B)	1.25 (B)				1.15 (M)	0.85 (9)
4.7μF (475)													1.25 (B)	1.60 (C)	1.15 (M)	1.15 (M)	1.15 (M)	
10μF (106)															1.60 (C)		1.15 (M)	1.15 (M)

The part numbering code is shown in each ( ).  
 T: 1.25±0.1mm is also available for GRM21 25V or 16V 1.0μF type.  
 Dimensions are shown in mm and Rated Voltage in Vdc.

# Chip Monolithic Ceramic Capacitors



## for Reflow Soldering GRM32/43/55 Series

2

### ■ Features

1. Terminations are made of metal highly resistant to migration.
2. The GRM series is a complete line of chip ceramic capacitors in 10V, 16V, 25V, 50V, 100V and 200V ratings. These capacitors have temperature characteristics ranging from C0G to Y5V.
3. This series consists of type LxWxT: 3.2x2.5x0.85mm to LxWxT: 5.7x5.0x2.5mm. These are suited to only reflow soldering.

Part Number	Dimensions (mm)				
	L	W	T	e min.	g min.
GRM329	3.2 ±0.3	2.5 ±0.2	0.85 ±0.1	0.3	1.0
GRM32M			1.15 ±0.1		
GRM32N			1.35 ±0.15		
GRM32R			1.8 ±0.2		
GRM32E			2.5 ±0.2		
GRM43M	4.5 ±0.4	3.2 ±0.3	1.15 ±0.1	0.3	2.0
GRM43R			1.35 ±0.15		
GRM43D			2.0 ±0.2		
GRM43E			2.5 ±0.2		
GRM55M			5.7 ±0.4		
GRM55N	1.35 ±0.15				
GRM55C	1.6 ±0.2				
GRM55R	1.8 ±0.2				
GRM55D	2.0 ±0.2				
GRM55E	2.5 ±0.2				

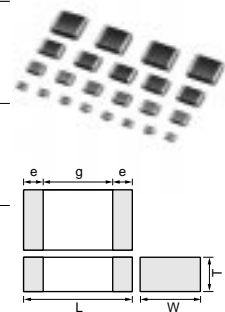

### ■ Applications

General electronic equipment

## Temperature Compensating Type GRM32/43/55 Series

Part Number	TC Code (Standard)	Rated Voltage (Vdc)	Capacitance (pF)	Length L (mm)	Width W (mm)	Thickness T (mm)
GRM32N5C2D561JV01	C0G (EIA)	200	560 ±5%	3.20	2.50	1.35
GRM32N5C2D681JY21	C0G (EIA)	200	680 ±5%	3.20	2.50	1.35
GRM32N5C2D821JY21	C0G (EIA)	200	820 ±5%	3.20	2.50	1.35
GRM32N5C2D102JY21	C0G (EIA)	200	1000 ±5%	3.20	2.50	1.35
GRM43R5C2D122JV01	C0G (EIA)	200	1200 ±5%	4.50	3.20	1.80
GRM43R5C2D152JV01	C0G (EIA)	200	1500 ±5%	4.50	3.20	1.80
GRM43R5C2D182JY21	C0G (EIA)	200	1800 ±5%	4.50	3.20	1.80
GRM43R5C2D222JY21	C0G (EIA)	200	2200 ±5%	4.50	3.20	1.80
GRM43R5C2D272JY21	C0G (EIA)	200	2700 ±5%	4.50	3.20	1.80
GRM55N5C2D332JY21	C0G (EIA)	200	3300 ±5%	5.70	5.00	1.35
GRM55R5C2D392JY21	C0G (EIA)	200	3900 ±5%	5.70	5.00	1.80
GRM55R5C2D472JY21	C0G (EIA)	200	4700 ±5%	5.70	5.00	1.80
GRM55R5C2D562JY21	C0G (EIA)	200	5600 ±5%	5.70	5.00	1.80
GRM32N1X2D152JV01	SL (JIS)	200	1500 ±5%	3.20	2.50	1.35
GRM43N1X2D182JV01	SL (JIS)	200	1800 ±5%	4.50	3.20	1.35
GRM43N1X2D222JV01	SL (JIS)	200	2200 ±5%	4.50	3.20	1.35
GRM43R1X2D272JV01	SL (JIS)	200	2700 ±5%	4.50	3.20	1.80
GRM43R1X2D332JV01	SL (JIS)	200	3300 ±5%	4.50	3.20	1.80
GRM43R1X2D392JV01	SL (JIS)	200	3900 ±5%	4.50	3.20	1.80
GRM55N1X2D472JV01	SL (JIS)	200	4700 ±5%	5.70	5.00	1.35
GRM55R1X2D562JV01	SL (JIS)	200	5600 ±5%	5.70	5.00	1.80
GRM55R1X2D682JV01	SL (JIS)	200	6800 ±5%	5.70	5.00	1.80
GRM55R1X2D822JV01	SL (JIS)	200	8200 ±5%	5.70	5.00	1.80
GRM32N1X2A562JZ01	SL (JIS)	100	5600 ±5%	3.20	2.50	1.35
GRM32N1X2A682JZ01	SL (JIS)	100	6800 ±5%	3.20	2.50	1.35
GRM43N1X2A822JZ01	SL (JIS)	100	8200 ±5%	4.50	3.20	1.35
GRM43R1X2A103JZ01	SL (JIS)	100	10000 ±5%	4.50	3.20	1.80
GRM43R1X2A123JZ01	SL (JIS)	100	12000 ±5%	4.50	3.20	1.80
GRM43R1X2A153JZ01	SL (JIS)	100	15000 ±5%	4.50	3.20	1.80
GRM55M1X2A183JZ01	SL (JIS)	100	18000 ±5%	5.70	5.00	1.15
GRM55N1X2A223JZ01	SL (JIS)	100	22000 ±5%	5.70	5.00	1.35
GRM55R1X2A273JZ01	SL (JIS)	100	27000 ±5%	5.70	5.00	1.80
GRM55R1X2A333JZ01	SL (JIS)	100	33000 ±5%	5.70	5.00	1.80
GRM55R1X2A393JZ01	SL (JIS)	100	39000 ±5%	5.70	5.00	1.80

Continued on the following page.

Continued from the preceding page.

Part Number	TC Code (Standard)	Rated Voltage (Vdc)	Capacitance (pF)	Length L (mm)	Width W (mm)	Thickness T (mm)
GRM32N1X1H103JZ01	SL (JIS)	50	10000 ±5%	3.20	2.50	1.35
GRM32N1X1H123JZ01	SL (JIS)	50	12000 ±5%	3.20	2.50	1.35
GRM43R1X1H153JZ01	SL (JIS)	50	15000 ±5%	4.50	3.20	1.80
GRM55M1X1H183JZ01	SL (JIS)	50	18000 ±5%	5.70	5.00	1.15
GRM55N1X1H223JZ01	SL (JIS)	50	22000 ±5%	5.70	5.00	1.35
GRM55R1X1H273JZ01	SL (JIS)	50	27000 ±5%	5.70	5.00	1.80
GRM55R1X1H333JZ01	SL (JIS)	50	33000 ±5%	5.70	5.00	1.80
GRM55R1X1H393JZ01	SL (JIS)	50	39000 ±5%	5.70	5.00	1.80

### High Dielectric Constant Type Type GRM32 Series (3.20x2.50mm)

Part Number	TC Code (Standard)	Rated Voltage (Vdc)	Capacitance	Length L (mm)	Width W (mm)	Thickness T (mm)
GRM32ER61A106KA01	X5R (EIA)	10	10μF ±10%	3.20	2.50	2.50
GRM32NR72A683KA01	X7R (EIA)	100	68000pF ±10%	3.20	2.50	1.35
GRM32NR72A104KA01	X7R (EIA)	100	0.10μF ±10%	3.20	2.50	1.35
GRM32CR72A684KA01	X7R (EIA)	100	0.68μF ±10%	3.20	2.50	1.60
GRM32CR72A105KA35	X7R (EIA)	100	1.0μF ±10%	3.20	2.50	1.60
GRM32ER72A105KA01	X7R (EIA)	100	1.0μF ±10%	3.20	2.50	2.50
GRM32DR72A155KA35	X7R (EIA)	100	1.5μF ±10%	3.20	2.50	2.00
GRM32ER72A225KA35	X7R (EIA)	100	2.2μF ±10%	3.20	2.50	2.50
GRM32NR71H684KA01	X7R (EIA)	50	0.68μF ±10%	3.20	2.50	1.35
GRM32DR71H335KA88	X7R (EIA)	50	3.3μF ±10%	3.20	2.50	2.00
GRM32ER71H475KA88	X7R (EIA)	50	4.7μF ±10%	3.20	2.50	2.50
GRM32NR71E155KA01	X7R (EIA)	25	1.5μF ±10%	3.20	2.50	1.35
GRM32RR71E225KA01	X7R (EIA)	25	2.2μF ±10%	3.20	2.50	1.80
GRM32DR71E335KA01	X7R (EIA)	25	3.3μF ±10%	3.20	2.50	2.00
GRM32DR71E475KA61	X7R (EIA)	25	4.7μF ±10%	3.20	2.50	2.00
GRM32MR71C225KA01	X7R (EIA)	16	2.2μF ±10%	3.20	2.50	1.15
GRM32NR71C335KA01	X7R (EIA)	16	3.3μF ±10%	3.20	2.50	1.35
GRM32RR71C475KA01	X7R (EIA)	16	4.7μF ±10%	3.20	2.50	1.80
GRM32DR71C106KA01	X7R (EIA)	16	10μF ±10%	3.20	2.50	2.00
GRM32NF52A104ZA01	Y5V (EIA)	100	0.10μF +80/-20%	3.20	2.50	1.35
GRM32RF51H105ZA01	Y5V (EIA)	50	1.0μF +80/-20%	3.20	2.50	1.80
GRM32DF51H106ZA01	Y5V (EIA)	50	10μF +80/-20%	3.20	2.50	2.00
GRM329F51E475ZA01	Y5V (EIA)	25	4.7μF +80/-20%	3.20	2.50	0.85
GRM32NF51E106ZA01	Y5V (EIA)	25	10μF +80/-20%	3.20	2.50	1.35
GRM32NF51C106ZA01	Y5V (EIA)	16	10μF +80/-20%	3.20	2.50	1.35

### High Dielectric Constant Type Type GRM43 Series (4.50x3.20mm)

Part Number	TC Code (Standard)	Rated Voltage (Vdc)	Capacitance (μF)	Length L (mm)	Width W (mm)	Thickness T (mm)
GRM43RR72A154KA01	X7R (EIA)	100	0.15 ±10%	4.50	3.20	1.80
GRM43RR72A224KA01	X7R (EIA)	100	0.22 ±10%	4.50	3.20	1.80
GRM43DR72A474KA01	X7R (EIA)	100	0.47 ±10%	4.50	3.20	2.00
GRM43DR72A155KA01	X7R (EIA)	100	1.5 ±10%	4.50	3.20	2.00
GRM43ER72A225KA01	X7R (EIA)	100	2.2 ±10%	4.50	3.20	2.50
GRM43DR71H155KA01	X7R (EIA)	50	1.5 ±10%	4.50	3.20	2.00
GRM43ER71H225KA01	X7R (EIA)	50	2.2 ±10%	4.50	3.20	2.50
GRM43ER71E475KA01	X7R (EIA)	25	4.7 ±10%	4.50	3.20	2.50
GRM43RF52A224ZD01	Y5V (EIA)	100	0.22 +80/-20%	4.50	3.20	1.80

## High Dielectric Constant Type GRM55 Series (5.70x5.00mm)

2

Part Number	TC Code (Standard)	Rated Voltage (Vdc)	Capacitance (μF)	Length L (mm)	Width W (mm)	Thickness T (mm)
<b>GRM55DR61H106KA88</b>	X5R (EIA)	50	10 ±10%	5.70	5.00	2.00
<b>GRM55DR72A105KA01</b>	X7R (EIA)	100	1.0 ±10%	5.70	5.00	2.00
<b>GRM55ER72A475KA01</b>	X7R (EIA)	100	4.7 ±10%	5.70	5.00	2.50
<b>GRM55RR71H105KA01</b>	X7R (EIA)	50	1.0 ±10%	5.70	5.00	1.80
<b>GRM55RR71H155KA01</b>	X7R (EIA)	50	1.5 ±10%	5.70	5.00	1.80
<b>GRM55ER11H475KA01</b>	X7R (EIA)	50	4.7 ±10%	5.70	5.00	2.50
<b>GRM55ER71H475KA01</b>	X7R (EIA)	50	4.7 ±10%	5.70	5.00	2.50
<b>GRM55RF52A474ZA01</b>	Y5V (EIA)	100	0.47 +80/-20%	5.70	5.00	1.80

# Chip Monolithic Ceramic Capacitors



## Ultra-small GRM02/03 Series

### ■ Features

1. Small chip size (LxWxT: 0.4x0.2x0.2, 0.6x0.3x0.3 mm)
2. Terminations are made of metal highly resistant to migration.
3. GRM02, GRM03 series is suited to only reflow soldering.
4. Stringent dimensional tolerances allow highly reliable, high speed automatic chip placement on PCBs.
5. GRM02, GRM03 series are suited to miniature micro wave module, portable equipment and high frequency circuits.

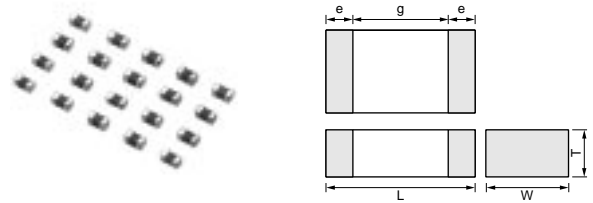

Part Number	Dimensions (mm)				
	L	W	T	e	g min.
<b>GRM022</b>	0.4 ±0.02	0.2 ±0.02	0.2 ±0.02	0.07 to 0.14	0.13
<b>GRM033</b>	0.6 ±0.03	0.3 ±0.03	0.3 ±0.03	0.1 to 0.2	0.2

### ■ Applications

1. Miniature micro wave module
2. Portable equipment
3. High frequency circuit

Part Number	<b>GRM02</b>		<b>GRM03</b>										
	L x W	0.4x0.2 [01005]	0.6x0.3 [0201]										
TC	C0G (5C)	C0G (5C)	R2H (6R)	S2H (6S)	T2H (6T)	U2J (7U)	X5R (R6)	X7R (R7)				Y5V (F5)	
Rated Volt.	16 (1C)	25 (1E)	25 (1E)	25 (1E)	25 (1E)	50 (1H)	25 (1E)	10 (1A)	25 (1E)	16 (1C)	10 (1A)	6.3 (0J)	10 (1A)
Capacitance (Capacitance part numbering code) and T (mm) Dimension (T Dimension part numbering code)													
0.30pF (R30)		0.3(3)											
0.40pF (R40)		0.3(3)											
0.50pF (R50)		0.3(3)											
0.60pF (R60)		0.3(3)											
0.70pF (R70)		0.3(3)											
0.75pF (R75)		0.3(3)											
0.80pF (R80)		0.3(3)											
0.90pF (R90)		0.3(3)											
1.0pF (1R0)	0.2(2)	0.3(3)											
1.1pF (1R1)		0.3(3)											
1.2pF (1R2)		0.3(3)											
1.3pF (1R3)		0.3(3)											
1.4pF (1R4)		0.3(3)											
1.5pF (1R5)		0.3(3)											
1.6pF (1R6)		0.3(3)											
1.7pF (1R7)		0.3(3)											
1.8pF (1R8)		0.3(3)											
1.9pF (1R9)		0.3(3)											
2.0pF (2R0)	0.2(2)	0.3(3)											
2.1pF (2R1)		0.3(3)											
2.2pF (2R2)		0.3(3)											
2.3pF (2R3)		0.3(3)											
2.4pF (2R4)		0.3(3)											
2.5pF (2R5)		0.3(3)											
2.6pF (2R6)		0.3(3)											
2.7pF (2R7)		0.3(3)											

Continued on the following page.

Continued from the preceding page.

Part Number	GRM02		GRM03										
L x W	0.4x0.2 [01005]		0.6x0.3 [0201]										
TC	C0G (5C)	C0G (5C)	R2H (6R)	S2H (6S)	T2H (6T)	U2J (7U)		X5R (R6)	X7R (R7)				Y5V (F5)
Rated Volt.	16 (1C)	25 (1E)	25 (1E)	25 (1E)	25 (1E)	50 (1H)	25 (1E)	10 (1A)	25 (1E)	16 (1C)	10 (1A)	6.3 (0J)	10 (1A)
Capacitance (Capacitance part numbering code) and T (mm) Dimension (T Dimension part numbering code)													
2.8pF(2R8)		0.3(3)											
2.9pF(2R9)		0.3(3)											
3.0pF(3R0)	0.2(2)	0.3(3)	0.3(3)	0.3(3)	0.3(3)	0.3(3)							
3.1pF(3R1)		0.3(3)											
3.2pF(3R2)		0.3(3)											
3.3pF(3R3)		0.3(3)											
3.4pF(3R4)		0.3(3)											
3.5pF(3R5)		0.3(3)											
3.6pF(3R6)		0.3(3)											
3.7pF(3R7)		0.3(3)											
3.8pF(3R8)		0.3(3)											
3.9pF(3R9)		0.3(3)											
4.0pF(4R0)	0.2(2)	0.3(3)	0.3(3)	0.3(3)	0.3(3)	0.3(3)							
4.1pF(4R1)		0.3(3)											
4.2pF(4R2)		0.3(3)											
4.3pF(4R3)		0.3(3)											
4.4pF(4R4)		0.3(3)											
4.5pF(4R5)		0.3(3)											
4.6pF(4R6)		0.3(3)											
4.7pF(4R7)		0.3(3)											
4.8pF(4R8)		0.3(3)											
4.9pF(4R9)		0.3(3)											
5.0pF(5R0)	0.2(2)	0.3(3)	0.3(3)	0.3(3)	0.3(3)	0.3(3)							
5.1pF(5R1)		0.3(3)											
5.2pF(5R2)		0.3(3)											
5.3pF(5R3)		0.3(3)											
5.4pF(5R4)		0.3(3)											
5.5pF(5R5)		0.3(3)											
5.6pF(5R6)		0.3(3)											
5.7pF(5R7)		0.3(3)											
5.8pF(5R8)		0.3(3)											
5.9pF(5R9)		0.3(3)											
6.0pF(6R0)	0.2(2)	0.3(3)	0.3(3)	0.3(3)	0.3(3)	0.3(3)							
6.1pF(6R1)		0.3(3)											
6.2pF(6R2)		0.3(3)											
6.3pF(6R3)		0.3(3)											
6.4pF(6R4)		0.3(3)											
6.5pF(6R5)		0.3(3)											
6.6pF(6R6)		0.3(3)											
6.7pF(6R7)		0.3(3)											
6.8pF(6R8)		0.3(3)											
6.9pF(6R9)		0.3(3)											
7.0pF(7R0)	0.2(2)	0.3(3)	0.3(3)	0.3(3)	0.3(3)	0.3(3)							
7.1pF(7R1)		0.3(3)											
7.2pF(7R2)		0.3(3)											
7.3pF(7R3)		0.3(3)											
7.4pF(7R4)		0.3(3)											
7.5pF(7R5)		0.3(3)											
7.6pF(7R6)		0.3(3)											
7.7pF(7R7)		0.3(3)											
7.8pF(7R8)		0.3(3)											
7.9pF(7R9)		0.3(3)											

Continued on the following page. 

Continued from the preceding page.

Part Number	GRM02		GRM03										
L x W	0.4x0.2 [01005]		0.6x0.3 [0201]										
TC	C0G (5C)	C0G (5C)	R2H (6R)	S2H (6S)	T2H (6T)	U2J (7U)		X5R (R6)	X7R (R7)			Y5V (F5)	
Rated Volt.	16 (1C)	25 (1E)	25 (1E)	25 (1E)	25 (1E)	50 (1H)	25 (1E)	10 (1A)	25 (1E)	16 (1C)	10 (1A)	6.3 (0J)	10 (1A)
Capacitance (Capacitance part numbering code) and T (mm) Dimension (T Dimension part numbering code)													
8.0pF(8R0)	0.2(2)	0.3(3)	0.3(3)	0.3(3)	0.3(3)	0.3(3)							
8.1pF(8R1)		0.3(3)											
8.2pF(8R2)		0.3(3)											
8.3pF(8R3)		0.3(3)											
8.4pF(8R4)		0.3(3)											
8.5pF(8R5)		0.3(3)											
8.6pF(8R6)		0.3(3)											
8.7pF(8R7)		0.3(3)											
8.8pF(8R8)		0.3(3)											
8.9pF(8R9)		0.3(3)											
9.0pF(9R0)	0.2(2)	0.3(3)	0.3(3)	0.3(3)	0.3(3)	0.3(3)							
9.1pF(9R1)		0.3(3)											
9.2pF(9R2)		0.3(3)											
9.3pF(9R3)		0.3(3)											
9.4pF(9R4)		0.3(3)											
9.5pF(9R5)		0.3(3)											
9.6pF(9R6)		0.3(3)											
9.7pF(9R7)		0.3(3)											
9.8pF(9R8)		0.3(3)											
9.9pF(9R9)		0.3(3)											
10pF(100)	0.2(2)	0.3(3)	0.3(3)	0.3(3)	0.3(3)	0.3(3)							
12pF(120)	0.2(2)	0.3(3)	0.3(3)	0.3(3)	0.3(3)	0.3(3)							
15pF(150)	0.2(2)	0.3(3)	0.3(3)	0.3(3)	0.3(3)	0.3(3)							
18pF(180)		0.3(3)	0.3(3)	0.3(3)	0.3(3)		0.3(3)						
22pF(220)		0.3(3)	0.3(3)	0.3(3)	0.3(3)		0.3(3)						
27pF(270)		0.3(3)	0.3(3)	0.3(3)	0.3(3)		0.3(3)						
33pF(330)		0.3(3)	0.3(3)	0.3(3)	0.3(3)		0.3(3)						
39pF(390)		0.3(3)	0.3(3)	0.3(3)	0.3(3)		0.3(3)						
47pF(470)		0.3(3)	0.3(3)	0.3(3)	0.3(3)		0.3(3)						
56pF(560)		0.3(3)	0.3(3)	0.3(3)	0.3(3)		0.3(3)						
68pF(680)		0.3(3)	0.3(3)	0.3(3)	0.3(3)		0.3(3)						
82pF(820)		0.3(3)	0.3(3)	0.3(3)	0.3(3)		0.3(3)						
100pF(101)		0.3(3)	0.3(3)	0.3(3)	0.3(3)		0.3(3)		0.3(3)	0.3(3)			
150pF(151)									0.3(3)	0.3(3)			
220pF(221)									0.3(3)	0.3(3)			
330pF(331)									0.3(3)	0.3(3)			
470pF(471)									0.3(3)	0.3(3)			
680pF(681)									0.3(3)	0.3(3)			
1000pF(102)									0.3(3)	0.3(3)			
1500pF(152)								0.3(3)	0.3(3)			0.3(3)	
2200pF(222)								0.3(3)		0.3(3)	0.3(3)	0.3(3)	0.3(3)
3300pF(332)								0.3(3)		0.3(3)	0.3(3)	0.3(3)	
4700pF(472)								0.3(3)		0.3(3)	0.3(3)	0.3(3)	0.3(3)
6800pF(682)								0.3(3)		0.3(3)	0.3(3)		
10000pF(103)								0.3(3)		0.3(3)	0.3(3)	0.3(3)	0.3(3)

The part numbering code is shown in ( ).  
 Dimensions are shown in mm and Rated Voltage in Vdc.

# Chip Monolithic Ceramic Capacitors



## Tight Tolerance GRM03/15 Series

4

### ■ Features

1. Terminations are made of metal highly resistant to migration.
2. A wide selection of sizes is available, from the miniature LxWxT: 0.6x0.3x0.3mm or LxWxT: 1.0x0.5x0.5mm.
3. The GRM03 type is a complete line of chip ceramic capacitors in 25V ratings, The GRM15 type is a complete line of chip ceramic capacitors in 50V ratings.
4. These capacitors have temperature characteristics ranging COG.
5. GRM03 and GRM15 type are applied to only reflow soldering.
6. Stringent dimensional tolerances allow highly reliable, high speed automatic chip placement on PCBs.
7. The GRM series is available in paper tape and reel packaging for automatic placement.

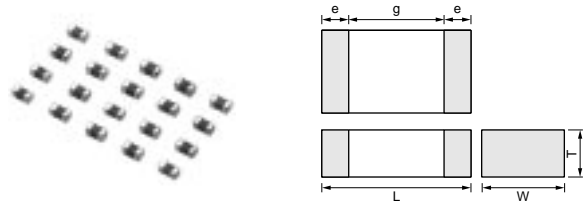

Part Number	Dimensions (mm)				
	L	W	T	e	g min.
<b>GRM033</b>	0.6±0.03	0.3±0.03	0.3±0.03	0.1 to 0.2	0.2
<b>GRM155</b>	1.0±0.05	0.5±0.05	0.5±0.05	0.15 to 0.3	0.4

### ■ Applications

General electronic equipment

## Temperature Compensating Type GRM03/15 Series

Part Number	GRM03	GRM15
L x W [EIA]	0.60x0.30 [0201]	1.00x0.50 [0402]
TC	COG (5C)	COG (5C)
Rated Volt.	25 (1E)	50 (1H)
Capacitance, Capacitance Tolerance and T Dimension		
0.10pF(R10)	<b>M, N</b> 0.30(3)	0.50(5)
0.20pF(R20)	<b>K, M</b> 0.30(3)	0.50(5)
0.30pF(R30)	<b>K, M</b> 0.30(3)	0.50(5)
0.40pF(R40)	<b>K, M</b> 0.30(3)	0.50(5)
0.50pF(R50)	<b>K, M</b> 0.30(3)	0.50(5)
0.60pF(R60)	<b>K, M</b> 0.30(3)	0.50(5)
0.70pF(R70)	<b>K, M</b> 0.30(3)	0.50(5)
0.80pF(R80)	<b>K, M</b> 0.30(3)	0.50(5)
0.90pF(R90)	<b>K, M</b> 0.30(3)	0.50(5)
1.0pF(1R0)	<b>J, K</b> 0.30(3)	0.50(5)
1.1pF(1R1)	<b>J, K</b> 0.30(3)	0.50(5)
1.2pF(1R2)	<b>J, K</b> 0.30(3)	0.50(5)
1.3pF(1R3)	<b>J, K</b> 0.30(3)	0.50(5)
1.4pF(1R4)	<b>J, K</b> 0.30(3)	0.50(5)
1.5pF(1R5)	<b>J, K</b> 0.30(3)	0.50(5)
1.6pF(1R6)	<b>J, K</b> 0.30(3)	0.50(5)
1.7pF(1R7)	<b>J, K</b> 0.30(3)	0.50(5)
1.8pF(1R8)	<b>J, K</b> 0.30(3)	0.50(5)
1.9pF(1R9)	<b>J, K</b> 0.30(3)	0.50(5)

The part numbering code is shown in ( ).  
 Dimensions are shown in mm and Rated Voltage in Vdc.

Continued on the following page.





 Continued from the preceding page.

Part Number		GRM03	GRM15
L x W [EIA]		0.60x0.30 [0201]	1.00x0.50 [0402]
TC		COG (5C)	COG (5C)
Rated Volt.		25 (1E)	50 (1H)
<b>Capacitance, Capacitance Tolerance and T Dimension</b>			
2.0pF(2R0)	G, J	0.30(3)	0.50(5)
2.1pF(2R1)	G, J	0.30(3)	0.50(5)
2.2pF(2R2)	G, J	0.30(3)	0.50(5)
2.3pF(2R3)	G, J	0.30(3)	0.50(5)
2.4pF(2R4)	G, J	0.30(3)	0.50(5)
2.5pF(2R5)	G, J	0.30(3)	0.50(5)
2.6pF(2R6)	G, J	0.30(3)	0.50(5)
2.7pF(2R7)	G, J	0.30(3)	0.50(5)
2.8pF(2R8)	G, J	0.30(3)	0.50(5)
2.9pF(2R9)	G, J	0.30(3)	0.50(5)
3.0pF(3R0)	G, J	0.30(3)	0.50(5)
3.1pF(3R1)	G, J	0.30(3)	0.50(5)
3.2pF(3R2)	G, J	0.30(3)	0.50(5)
3.3pF(3R3)	G, J	0.30(3)	0.50(5)
3.4pF(3R4)	G, J	0.30(3)	0.50(5)
3.5pF(3R5)	G, J	0.30(3)	0.50(5)
3.6pF(3R6)	G, J	0.30(3)	0.50(5)
3.7pF(3R7)	G, J	0.30(3)	0.50(5)
3.8pF(3R8)	G, J	0.30(3)	0.50(5)
3.9pF(3R9)	G, J	0.30(3)	0.50(5)
4.0pF(4R0)	G, J	0.30(3)	0.50(5)
4.1pF(4R1)	G, J	0.30(3)	0.50(5)
4.2pF(4R2)	G, J	0.30(3)	0.50(5)
4.3pF(4R3)	G, J	0.30(3)	0.50(5)
4.4pF(4R4)	G, J	0.30(3)	0.50(5)
4.5pF(4R5)	G, J	0.30(3)	0.50(5)
4.6pF(4R6)	G, J	0.30(3)	0.50(5)
4.7pF(4R7)	G, J	0.30(3)	0.50(5)
4.8pF(4R8)	G, J	0.30(3)	0.50(5)
4.9pF(4R9)	G, J	0.30(3)	0.50(5)
5.0pF(5R0)	F, G	0.30(3)	0.50(5)
5.1pF(5R1)	F, G	0.30(3)	0.50(5)
5.2pF(5R2)	F, G	0.30(3)	0.50(5)
5.3pF(5R3)	F, G	0.30(3)	0.50(5)
5.4pF(5R4)	F, G	0.30(3)	0.50(5)
5.5pF(5R5)	F, G	0.30(3)	0.50(5)
5.6pF(5R6)	F, G	0.30(3)	0.50(5)
5.7pF(5R7)	F, G	0.30(3)	0.50(5)
5.8pF(5R8)	F, G	0.30(3)	0.50(5)
5.9pF(5R9)	F, G	0.30(3)	0.50(5)
6.0pF(6R0)	F, G	0.30(3)	0.50(5)
6.1pF(6R1)	F, G	0.30(3)	0.50(5)
6.2pF(6R2)	F, G	0.30(3)	0.50(5)
6.3pF(6R3)	F, G	0.30(3)	0.50(5)
6.4pF(6R4)	F, G	0.30(3)	0.50(5)
6.5pF(6R5)	F, G	0.30(3)	0.50(5)
6.6pF(6R6)	F, G	0.30(3)	0.50(5)
6.7pF(6R7)	F, G	0.30(3)	0.50(5)
6.8pF(6R8)	F, G	0.30(3)	0.50(5)
6.9pF(6R9)	F, G	0.30(3)	0.50(5)

The part numbering code is shown in ( ).  
Dimensions are shown in mm and Rated Voltage in Vdc.

Continued on the following page. 

Continued from the preceding page.

Part Number		GRM03	GRM15
L x W [EIA]		0.60x0.30 [0201]	1.00x0.50 [0402]
TC		COG (5C)	COG (5C)
Rated Volt.		25 (1E)	50 (1H)
Capacitance, Capacitance Tolerance and T Dimension			
7.0pF(7R0)	F, G	0.30(3)	0.50(5)
7.1pF(7R1)	F, G	0.30(3)	0.50(5)
7.2pF(7R2)	F, G	0.30(3)	0.50(5)
7.3pF(7R3)	F, G	0.30(3)	0.50(5)
7.4pF(7R4)	F, G	0.30(3)	0.50(5)
7.5pF(7R5)	F, G	0.30(3)	0.50(5)
7.6pF(7R6)	F, G	0.30(3)	0.50(5)
7.7pF(7R7)	F, G	0.30(3)	0.50(5)
7.8pF(7R8)	F, G	0.30(3)	0.50(5)
7.9pF(7R9)	F, G	0.30(3)	0.50(5)
8.0pF(8R0)	F, G	0.30(3)	0.50(5)
8.1pF(8R1)	F, G	0.30(3)	0.50(5)
8.2pF(8R2)	F, G	0.30(3)	0.50(5)
8.3pF(8R3)	F, G	0.30(3)	0.50(5)
8.4pF(8R4)	F, G	0.30(3)	0.50(5)
8.5pF(8R5)	F, G	0.30(3)	0.50(5)
8.6pF(8R6)	F, G	0.30(3)	0.50(5)
8.7pF(8R7)	F, G	0.30(3)	0.50(5)
8.8pF(8R8)	F, G	0.30(3)	0.50(5)
8.9pF(8R9)	F, G	0.30(3)	0.50(5)
9.0pF(9R0)	F, G	0.30(3)	0.50(5)
9.1pF(9R1)	F, G	0.30(3)	0.50(5)
9.2pF(9R2)	F, G	0.30(3)	0.50(5)
9.3pF(9R3)	F, G	0.30(3)	0.50(5)
9.4pF(9R4)	F, G	0.30(3)	0.50(5)
9.5pF(9R5)	F, G	0.30(3)	0.50(5)
9.6pF(9R6)	F, G	0.30(3)	0.50(5)
9.7pF(9R7)	F, G	0.30(3)	0.50(5)
9.8pF(9R8)	F, G	0.30(3)	0.50(5)
9.9pF(9R9)	F, G	0.30(3)	0.50(5)

The part numbering code is shown in ( ).

Dimensions are shown in mm and Rated Voltage in Vdc.

# Chip Monolithic Ceramic Capacitors



## Thin Type (Flow/Reflow)

### ■ Features

1. This series is suited to flow and reflow soldering. Capacitor terminations are made of metal highly resistant to migration.
2. Large capacitance values enable excellent bypass effects to be realized.
3. Its thin package makes this series ideally suited for the production of small electronic products and for mounting underneath ICs.

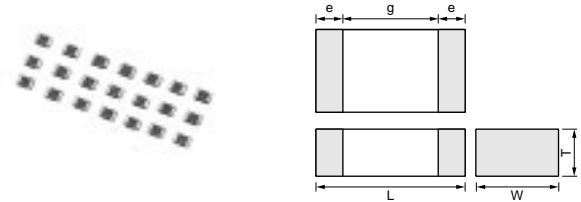

Part Number	Dimensions (mm)				
	L	W	T	e	g min.
<b>GRM15X</b>	1.0 ±0.05	0.5 ±0.05	0.25 ±0.05	0.1 to 0.3	0.4

### ■ Applications

Thin equipment such as IC cards

## Temperature Compensating Type

Part Number	TC Code (Standard)	Rated Voltage (Vdc)	Capacitance (pF)	Length L (mm)	Width W (mm)	Thickness T (mm)	EIA
<b>GRM15X5C1H1R0CDB4</b>	COG (EIA)	50	1.0 ±0.25pF	1.00	0.50	0.25	0402
<b>GRM15X5C1H2R0CDB4</b>	COG (EIA)	50	2.0 ±0.25pF	1.00	0.50	0.25	0402
<b>GRM15X5C1H3R0CDB4</b>	COG (EIA)	50	3.0 ±0.25pF	1.00	0.50	0.25	0402
<b>GRM15X5C1H4R0CDB4</b>	COG (EIA)	50	4.0 ±0.25pF	1.00	0.50	0.25	0402
<b>GRM15X5C1H5R0CDB4</b>	COG (EIA)	50	5.0 ±0.25pF	1.00	0.50	0.25	0402
<b>GRM15X5C1H6R0DDB4</b>	COG (EIA)	50	6.0 ±0.5pF	1.00	0.50	0.25	0402
<b>GRM15X5C1H7R0DDB4</b>	COG (EIA)	50	7.0 ±0.5pF	1.00	0.50	0.25	0402
<b>GRM15X5C1H8R0DDB4</b>	COG (EIA)	50	8.0 ±0.5pF	1.00	0.50	0.25	0402
<b>GRM15X5C1H9R0DDB4</b>	COG (EIA)	50	9.0 ±0.5pF	1.00	0.50	0.25	0402
<b>GRM15X5C1H100JDB4</b>	COG (EIA)	50	10 ±5%	1.00	0.50	0.25	0402
<b>GRM15X5C1H120JDB4</b>	COG (EIA)	50	12 ±5%	1.00	0.50	0.25	0402
<b>GRM15X5C1H150JDB4</b>	COG (EIA)	50	15 ±5%	1.00	0.50	0.25	0402
<b>GRM15X5C1H180JDB4</b>	COG (EIA)	50	18 ±5%	1.00	0.50	0.25	0402
<b>GRM15X5C1H220JDB4</b>	COG (EIA)	50	22 ±5%	1.00	0.50	0.25	0402
<b>GRM15X5C1H270JDB4</b>	COG (EIA)	50	27 ±5%	1.00	0.50	0.25	0402
<b>GRM15X5C1H330JDB4</b>	COG (EIA)	50	33 ±5%	1.00	0.50	0.25	0402
<b>GRM15X5C1H390JDB4</b>	COG (EIA)	50	39 ±5%	1.00	0.50	0.25	0402
<b>GRM15X5C1H470JDB4</b>	COG (EIA)	50	47 ±5%	1.00	0.50	0.25	0402
<b>GRM15X5C1H560JDB4</b>	COG (EIA)	50	56 ±5%	1.00	0.50	0.25	0402
<b>GRM15X5C1H680JDB4</b>	COG (EIA)	50	68 ±5%	1.00	0.50	0.25	0402
<b>GRM15X5C1H820JDB4</b>	COG (EIA)	50	82 ±5%	1.00	0.50	0.25	0402
<b>GRM15X5C1H101JDB4</b>	COG (EIA)	50	100 ±5%	1.00	0.50	0.25	0402
<b>GRM15X5C1E121JDB4</b>	COG (EIA)	25	120 ±5%	1.00	0.50	0.25	0402
<b>GRM15X5C1E151JDB4</b>	COG (EIA)	25	150 ±5%	1.00	0.50	0.25	0402
<b>GRM15X5C1E181JDB4</b>	COG (EIA)	25	180 ±5%	1.00	0.50	0.25	0402
<b>GRM15X5C1E221JDB4</b>	COG (EIA)	25	220 ±5%	1.00	0.50	0.25	0402

## High Dielectric Constant Type

Part Number	TC Code (Standard)	Rated Voltage (Vdc)	Capacitance (pF)	Length L (mm)	Width W (mm)	Thickness T (mm)	EIA
<b>GRM15XR71H221KA86</b>	X7R (EIA)	50	220 ±10%	1.00	0.50	0.25	0402
<b>GRM15XR71H331KA86</b>	X7R (EIA)	50	330 ±10%	1.00	0.50	0.25	0402
<b>GRM15XR71H471KA86</b>	X7R (EIA)	50	470 ±10%	1.00	0.50	0.25	0402
<b>GRM15XR71H681KA86</b>	X7R (EIA)	50	680 ±10%	1.00	0.50	0.25	0402
<b>GRM15XR71H102KA86</b>	X7R (EIA)	50	1000 ±10%	1.00	0.50	0.25	0402
<b>GRM15XR71H152KA86</b>	X7R (EIA)	50	1500 ±10%	1.00	0.50	0.25	0402
<b>GRM15XR71E222KA86</b>	X7R (EIA)	25	2200 ±10%	1.00	0.50	0.25	0402
<b>GRM15XR71C332KA86</b>	X7R (EIA)	16	3300 ±10%	1.00	0.50	0.25	0402
<b>GRM15XR71C472KA86</b>	X7R (EIA)	16	4700 ±10%	1.00	0.50	0.25	0402
<b>GRM15XR71C682KA86</b>	X7R (EIA)	16	6800 ±10%	1.00	0.50	0.25	0402
<b>GRM15XR61A223KA86</b>	X5R (EIA)	10	22000 ±10%	1.00	0.50	0.25	0402
<b>GRM15XR61A333KA86</b>	X5R (EIA)	10	33000 ±10%	1.00	0.50	0.25	0402

## GRM Series Specifications and Test Methods

No.	Item	Specifications		Test Method																
		Temperature Compensating Type	High Dielectric Type																	
1	Operating Temperature Range	-55 to +125°C	B1, B3, F1, R6 : -25 to +85°C R1, R7 : -55 to +125°C E4 : +10 to +85°C F5 : -30 to +85°C	Reference temperature : 25°C (2Δ, 3Δ, 4Δ, B1, B3, F1, R1, R6 : 20°C)																
2	Rated Voltage	See the previous pages.		The rated voltage is defined as the maximum voltage which may be applied continuously to the capacitor. When AC voltage is superimposed on DC voltage, $V^{P-P}$ or $V^{O-P}$ , whichever is larger, should be maintained within the rated voltage range.																
3	Appearance	No defects or abnormalities		Visual inspection																
4	Dimensions	Within the specified dimensions		Using calipers																
5	Dielectric Strength	No defects or abnormalities		No failure should be observed when *300% of the rated voltage (temperature compensating type) or 250% of the rated voltage (high dielectric constant type) is applied between the terminations for 1 to 5 seconds, provided the charge/discharge current is less than 50mA. *200% for 500V																
6	Insulation Resistance	$C \leq 0.047\mu\text{F}$ : More than 10,000MΩ $C > 0.047\mu\text{F}$ : $500\Omega \cdot \text{F}$ C : Nominal Capacitance		The insulation resistance should be measured with a DC voltage not exceeding the rated voltage at 20/25°C and 75%RH max. and within 2 minutes of charging, provided the charge/discharge current is less than 50mA.																
7	Capacitance	Within the specified tolerance		The capacitance/Q/D.F. should be measured at 20/25°C at the frequency and voltage shown in the table.																
8	Q/ Dissipation Factor (D.F.)	30pF and over : $Q \geq 1000$ 30pF and below : $Q \geq 400 + 20C$ C : Nominal Capacitance (pF)	[B1, B3, R1, R6, R7, E4, C8] W.V. : 25V min. : 0.025 max. W.V. : 16/10V : 0.035 max. W.V. : 6.3/4V : 0.05 max. ( $C < 3.3\mu\text{F}$ ) : 0.1 max. ( $C \geq 3.3\mu\text{F}$ ) [F1, F5] W.V. : 25V min. : 0.05 max. ( $C < 0.1\mu\text{F}$ ) : 0.09 max. ( $C \geq 0.1\mu\text{F}$ ) W.V. : 16/10V : 0.125 max. W.V. : 6.3V : 0.15 max.	<table border="1" style="width: 100%; text-align: center;"> <thead> <tr> <th>Char.</th> <th><math>\Delta C</math> to <math>\Delta U</math>, 1X (1000pF and below)</th> <th><math>\Delta C</math> to <math>\Delta U</math>, 1X (more than 1000pF) R6, R7, F5 B1, B3, F1</th> <th>E4</th> </tr> </thead> <tbody> <tr> <td>Item</td> <td></td> <td></td> <td></td> </tr> <tr> <td>Frequency</td> <td>1±0.1MHz</td> <td>1±0.1kHz</td> <td>1±0.1kHz</td> </tr> <tr> <td>Voltage</td> <td>0.5 to 5Vrms</td> <td>1±0.2Vrms</td> <td>0.5±0.05Vrms</td> </tr> </tbody> </table>	Char.	$\Delta C$ to $\Delta U$ , 1X (1000pF and below)	$\Delta C$ to $\Delta U$ , 1X (more than 1000pF) R6, R7, F5 B1, B3, F1	E4	Item				Frequency	1±0.1MHz	1±0.1kHz	1±0.1kHz	Voltage	0.5 to 5Vrms	1±0.2Vrms	0.5±0.05Vrms
Char.	$\Delta C$ to $\Delta U$ , 1X (1000pF and below)	$\Delta C$ to $\Delta U$ , 1X (more than 1000pF) R6, R7, F5 B1, B3, F1	E4																	
Item																				
Frequency	1±0.1MHz	1±0.1kHz	1±0.1kHz																	
Voltage	0.5 to 5Vrms	1±0.2Vrms	0.5±0.05Vrms																	

Continued on the following page.

## GRM Series Specifications and Test Methods

Continued from the preceding page.

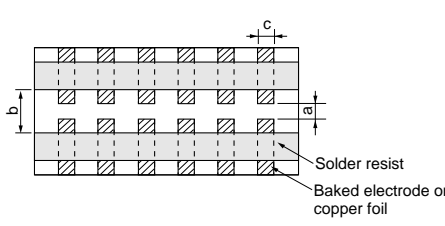
No.	Item	Specifications		Test Method																																						
		Temperature Compensating Type	High Dielectric Type																																							
9	Capacitance Temperature Characteristics	No bias	B1, B3 : Within $\pm 10\%$ (−25 to +85°C) R1, R7 : Within $\pm 15\%$ (−55 to +125°C) R6 : Within $\pm 15\%$ (−55 to +85°C) E4 : Within +22/−56% (+10 to +85°C) F1 : Within +30/−80% (−25 to +85°C) F5 : Within +22/−82% (−30 to +85°C) C8 : Within $\pm 22\%$ (−55 to +105°C)	The capacitance change should be measured after 5 min. at each specified temp. stage. (1) Temperature Compensating Type The temperature coefficient is determined using the capacitance measured in step 3 as a reference. When cycling the temperature sequentially from step 1 through 5 (5C : +25 to +125°C/ $\Delta C$ : +20 to +125°C : other temp. coeffs. : +25 to +85°C/+20 to +85°C) the capacitance should be within the specified tolerance for the temperature coefficient and capacitance change as Table A-1. The capacitance drift is calculated by dividing the differences between the maximum and minimum measured values in the step 1, 3 and 5 by the cap. value in step 3.																																						
		50% of the Rated Voltage	B1 : Within +10/−30% R1 : Within +15/−40% F1 : Within +30/−95%																																							
9	Capacitance Drift	Within $\pm 0.2\%$ or $\pm 0.05\text{pF}$ (Whichever is larger.) *Not apply to 1X/25V	*Initial measurement for high dielectric constant type Perform a heat treatment at 150+0/−10°C for one hour and then set for 24±2 hours at room temperature. Perform the initial measurement.	(2) High Dielectric Constant Type The ranges of capacitance change compared with the 20°C value over the temperature ranges shown in the table should be within the specified ranges.* In case of applying voltage, the capacitance change should be measured after 1 more min. with applying voltage in equilibration of each temp. stage.																																						
10	Adhesive Strength of Termination	No removal of the terminations or other defect should occur.		Solder the capacitor to the test jig (glass epoxy board) shown in Fig. 1a using an eutectic solder. Then apply 10N* force in parallel with the test jig for 10±1 sec. The soldering should be done either with an iron or using the reflow method and should be conducted with care so that the soldering is uniform and free of defects such as heat shock. *1N (GRM02), 2N (GR□03), 5N (GR□15, GRM18)																																						
		 <p>Fig. 1a</p>			<table border="1"> <thead> <tr> <th>Type</th> <th>a</th> <th>b</th> <th>c</th> </tr> </thead> <tbody> <tr> <td>GRM02</td> <td>0.2</td> <td>0.56</td> <td>0.23</td> </tr> <tr> <td>GR□03</td> <td>0.3</td> <td>0.9</td> <td>0.3</td> </tr> <tr> <td>GR□15</td> <td>0.4</td> <td>1.5</td> <td>0.5</td> </tr> <tr> <td>GRM18</td> <td>1.0</td> <td>3.0</td> <td>1.2</td> </tr> <tr> <td>GRM21</td> <td>1.2</td> <td>4.0</td> <td>1.65</td> </tr> <tr> <td>GRM31</td> <td>2.2</td> <td>5.0</td> <td>2.0</td> </tr> <tr> <td>GRM32</td> <td>2.2</td> <td>5.0</td> <td>2.9</td> </tr> <tr> <td>GRM43</td> <td>3.5</td> <td>7.0</td> <td>3.7</td> </tr> <tr> <td>GRM55</td> <td>4.5</td> <td>8.0</td> <td>5.6</td> </tr> </tbody> </table>	Type	a	b	c	GRM02	0.2	0.56	0.23	GR□03	0.3	0.9	0.3	GR□15	0.4	1.5	0.5	GRM18	1.0	3.0	1.2	GRM21	1.2	4.0	1.65	GRM31	2.2	5.0	2.0	GRM32	2.2	5.0	2.9	GRM43	3.5	7.0	3.7	GRM55
Type	a	b	c																																							
GRM02	0.2	0.56	0.23																																							
GR□03	0.3	0.9	0.3																																							
GR□15	0.4	1.5	0.5																																							
GRM18	1.0	3.0	1.2																																							
GRM21	1.2	4.0	1.65																																							
GRM31	2.2	5.0	2.0																																							
GRM32	2.2	5.0	2.9																																							
GRM43	3.5	7.0	3.7																																							
GRM55	4.5	8.0	5.6																																							

Continued on the following page. 

## GRM Series Specifications and Test Methods

Continued from the preceding page.

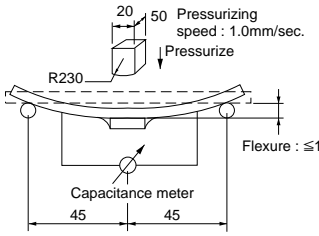
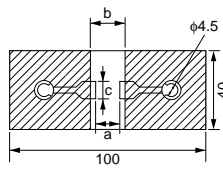
No.	Item	Specifications		Test Method																																						
		Temperature Compensating Type	High Dielectric Type																																							
11	Appearance	No defects or abnormalities		Solder the capacitor on the test jig (glass epoxy board) in the same manner and under the same conditions as (10). The capacitor should be subjected to a simple harmonic motion having a total amplitude of 1.5mm, the frequency being varied uniformly between the approximate limits of 10 and 55Hz. The frequency range, from 10 to 55Hz and return to 10Hz, should be traversed in approximately 1 minute. This motion should be applied for a period of 2 hours in each 3 mutually perpendicular directions (total of 6 hours).																																						
	Capacitance	Within the specified tolerance																																								
Vibration Resistance	Q/D.F.	30pF and over : $Q \geq 1000$ 30pF and below : $Q \geq 400+20C$  C : Nominal Capacitance (pF)	[B1, B3, R1, R6, R7, E4, C8] W.V. : 25V min. : 0.025 max. W.V. : 16/10V : 0.035 max. W.V. : 6.3/4V : 0.05 max. (C<3.3μF) : 0.1 max. (C≥3.3μF)  [F1, F5] W.V. : 25V min. : 0.05 max. (C<0.1μF) : 0.09 max. (C≥0.1μF) W.V. : 16/10V : 0.125 max. W.V. : 6.3V : 0.15 max.																																							
12	Deflection	No crack or marked defect should occur.		Solder the capacitor on the test jig (glass epoxy board) shown in Fig. 2a using an eutectic solder. Then apply a force in the direction shown in Fig. 3a for 5±1 sec. The soldering should be done either with an iron or using the reflow method and should be conducted with care so that the soldering is uniform and free of defects such as heat shock.																																						
		 <p style="text-align: center;">Fig. 3a</p>			 <p style="text-align: center;">Fig. 2a t : 1.6mm (GR□02/03/15 : t : 0.8mm)</p> <table border="1" style="margin-left: auto; margin-right: auto;"> <thead> <tr> <th>Type</th> <th>a</th> <th>b</th> <th>c</th> </tr> </thead> <tbody> <tr> <td>GRM02</td> <td>0.2</td> <td>0.56</td> <td>0.23</td> </tr> <tr> <td>GR□03</td> <td>0.3</td> <td>0.9</td> <td>0.3</td> </tr> <tr> <td>GR□15</td> <td>0.4</td> <td>1.5</td> <td>0.5</td> </tr> <tr> <td>GRM18</td> <td>1.0</td> <td>3.0</td> <td>1.2</td> </tr> <tr> <td>GRM21</td> <td>1.2</td> <td>4.0</td> <td>1.65</td> </tr> <tr> <td>GRM31</td> <td>2.2</td> <td>5.0</td> <td>2.0</td> </tr> <tr> <td>GRM32</td> <td>2.2</td> <td>5.0</td> <td>2.9</td> </tr> <tr> <td>GRM43</td> <td>3.5</td> <td>7.0</td> <td>3.7</td> </tr> <tr> <td>GRM55</td> <td>4.5</td> <td>8.0</td> <td>5.6</td> </tr> </tbody> </table> <p style="text-align: right;">(in mm)</p>	Type	a	b	c	GRM02	0.2	0.56	0.23	GR□03	0.3	0.9	0.3	GR□15	0.4	1.5	0.5	GRM18	1.0	3.0	1.2	GRM21	1.2	4.0	1.65	GRM31	2.2	5.0	2.0	GRM32	2.2	5.0	2.9	GRM43	3.5	7.0	3.7	GRM55
Type	a	b	c																																							
GRM02	0.2	0.56	0.23																																							
GR□03	0.3	0.9	0.3																																							
GR□15	0.4	1.5	0.5																																							
GRM18	1.0	3.0	1.2																																							
GRM21	1.2	4.0	1.65																																							
GRM31	2.2	5.0	2.0																																							
GRM32	2.2	5.0	2.9																																							
GRM43	3.5	7.0	3.7																																							
GRM55	4.5	8.0	5.6																																							
13	Solderability of Termination	75% of the terminations are to be soldered evenly and continuously.		Immerse the capacitor in a solution of ethanol (JIS-K-8101) and rosin (JIS-K-5902) (25% rosin in weight proportion) . Preheat at 80 to 120°C for 10 to 30 seconds. After preheating, immerse in an eutectic solder solution for 2±0.5 seconds at 230±5°C or Sn-3.0Ag-0.5Cu solder solution for 2±0.5 seconds at 245±5°C.																																						
14	The measured and observed characteristics should satisfy the specifications in the following table.			Preheat the capacitor at 120 to 150°C for 1 minute. Immerse the capacitor in an eutectic solder or Sn-3.0Ag-0.5Cu solder solution at 270±5°C for 10±0.5 seconds. Set at room temperature for 24±2 hours, then measure.																																						
	Appearance	No defects or abnormalities																																								
	Capacitance Change	Within ±2.5% or ±0.25pF (Whichever is larger)	B1, B3, R1, R6, R7, C8 : Within ±7.5% F1, F5, E4 : Within ±20%																																							
	Resistance to Soldering Heat	Q/D.F.	30pF and over : $Q \geq 1000$ 30pF and below : $Q \geq 400+20C$  C : Nominal Capacitance (pF)		[B1, B3, R1, R6, R7, E4, C8] W.V. : 25V min. : 0.025 max. W.V. : 16/10V : 0.035 max. W.V. : 6.3/4V : 0.05 max. (C<3.3μF) : 0.1 max. (C≥3.3μF)  [F1, F5] W.V. : 25V min. : 0.05 max. (C<0.1μF) : 0.09 max. (C≥0.1μF) W.V. : 16/10V : 0.125 max. W.V. : 6.3V : 0.15 max.																																					
			I.R.		More than 10,000MΩ or 500Ω · F (Whichever is smaller)																																					
Dielectric Strength	No defects		Perform a heat treatment at 150+0/-10°C for one hour and then set at room temperature for 24±2 hours. Perform the initial measurement.																																							
			•Preheating for GRM32/43/55																																							
			<table border="1" style="margin-left: auto; margin-right: auto;"> <thead> <tr> <th>Step</th> <th>Temperature</th> <th>Time</th> </tr> </thead> <tbody> <tr> <td>1</td> <td>100 to 120°C</td> <td>1 min.</td> </tr> <tr> <td>2</td> <td>170 to 200°C</td> <td>1 min.</td> </tr> </tbody> </table>	Step	Temperature	Time	1	100 to 120°C	1 min.	2	170 to 200°C	1 min.																														
Step	Temperature	Time																																								
1	100 to 120°C	1 min.																																								
2	170 to 200°C	1 min.																																								

Continued on the following page. ↗

## GRM Series Specifications and Test Methods

Continued from the preceding page.

No.	Item	Specifications		Test Method															
		Temperature Compensating Type	High Dielectric Type																
15	Temperature Cycle	The measured and observed characteristics should satisfy the specifications in the following table.		Fix the capacitor to the supporting jig in the same manner and under the same conditions as (10). Perform the five cycles according to the four heat treatments shown in the following table. Set for 24±2 hours at room temperature, then measure. <table border="1" style="margin: 10px auto;"> <thead> <tr> <th>Step</th> <th>1</th> <th>2</th> <th>3</th> <th>4</th> </tr> </thead> <tbody> <tr> <td>Temp. (°C)</td> <td>Min. Operating Temp. +0/-3</td> <td>Room Temp.</td> <td>Max. Operating Temp. +3/-0</td> <td>Room Temp.</td> </tr> <tr> <td>Time (min.)</td> <td>30±3</td> <td>2 to 3</td> <td>30±3</td> <td>2 to 3</td> </tr> </tbody> </table> •Initial measurement for high dielectric constant type Perform a heat treatment at 150+0/-10°C for one hour and then set at room temperature for 24±2 hours. Perform the initial measurement.	Step	1	2	3	4	Temp. (°C)	Min. Operating Temp. +0/-3	Room Temp.	Max. Operating Temp. +3/-0	Room Temp.	Time (min.)	30±3	2 to 3	30±3	2 to 3
		Step	1		2	3	4												
		Temp. (°C)	Min. Operating Temp. +0/-3		Room Temp.	Max. Operating Temp. +3/-0	Room Temp.												
		Time (min.)	30±3		2 to 3	30±3	2 to 3												
		Appearance	No defects or abnormalities																
		Capacitance Change	Within ±2.5% or ±0.25pF (Whichever is larger)		B1, B3, R1, R6, R7, C8 : Within ±7.5% F1, F5, E4 : Within ±20%														
Q/D.F.	30pF and over : Q≥1000 30pF and below : Q≥400+20C C : Nominal Capacitance (pF)	[B1, B3, R1, R6, R7, E4, C8] W.V. : 25V min. : 0.025 max. W.V. : 16/10V : 0.035 max. W.V. : 6.3/4V : 0.05 max. (C<3.3μF) : 0.1 max. (C≥3.3μF) [F1, F5] W.V. : 25V min. : 0.05 max. (C<0.1μF) : 0.09 max. (C≥0.1μF) W.V. : 16/10V : 0.125 max. W.V. : 6.3V : 0.15 max.																	
I.R.	More than 10,000MΩ or 500Ω · F (Whichever is smaller)																		
Dielectric Strength	No defects																		
16	Humidity (Steady State)	The measured and observed characteristics should satisfy the specifications in the following table.		Set the capacitor at 40±2°C and in 90 to 95% humidity for 500±12 hours. Remove and set for 24±2 hours at room temperature, then measure.															
		Appearance	No defects or abnormalities																
		Capacitance Change	Within ±5% or ±0.5pF (Whichever is larger)		B1, B3, R1, R6, R7, C8 : Within ±12.5% F1, F5 : Within ±30%														
		Q/D.F.	30pF and over : Q≥350 10pF and over : Q≥275+2.5C 30pF and below : Q≥200+10C C : Nominal Capacitance (pF)		[B1, B3, R1, R6, R7, E4, C8] W.V. : 25V min. : 0.05 max. W.V. : 16/10V : 0.05 max. W.V. : 6.3/4V : 0.075 max. (C<3.3μF) : 0.125 max. (C≥3.3μF) [F1, F5] W.V. : 25V min. : 0.075 max. (C<0.1μF) : 0.125 max. (C≥0.1μF) W.V. : 16/10V : 0.15 max. W.V. : 6.3V : 0.2 max.														
		I.R.	More than 1,000MΩ or 50Ω · F (Whichever is smaller)																

Continued on the following page.



## GRM Series Specifications and Test Methods

Continued from the preceding page.

No.	Item	Specifications		Test Method
		Temperature Compensating Type	High Dielectric Type	
17		The measured and observed characteristics should satisfy the specifications in the following table.		Apply the rated voltage at 40±2°C and 90 to 95% humidity for 500±12 hours. Remove and set for 24±2 hours at room temperature, then measure. The charge/discharge current is less than 50mA.  •Initial measurement for F1, F5/10V max. Apply the rated DC voltage for 1 hour at 40±2°C. Remove and set for 24±2 hours at room temperature. Perform initial measurement.
	Appearance	No defects or abnormalities		
	Capacitance Change	Within ±7.5% or ±0.75pF (Whichever is larger)	B1, B3, R1, R6, R7, C8 : Within ±12.5% F1, F5, E4 : Within ±30% [W.V. : 10V max.] F1, F5 : Within +30/-40%	
	Q/D.F.	30pF and over : Q≥200 30pF and below : Q≥100+10C/3  C : Nominal Capacitance (pF)	[B1, B3, R1, R6, R7, E4, C8] W.V. : 25V min. : 0.05 max. W.V. : 16/10V : 0.05 max. W.V. : 6.3V : 0.075 max. (C<3.3μF) : 0.125 max. (C≥3.3μF)  [F1, F5] W.V. : 25V min. : 0.075 max. (C<0.1μF) : 0.125 max. (C≥0.1μF) W.V. : 16/10V : 0.15 max. W.V. : 6.3V : 0.2 max.	
	I.R.	More than 500MΩ or 25Ω · F (Whichever is smaller)		
18		The measured and observed characteristics should satisfy the specifications in the following table.		Apply *200% of the rated voltage at the maximum operating temperature ±3°C for 1000±12 hours. Set for 24±2 hours at room temperature, then measure. The charge/discharge current is less than 50mA.  •Initial measurement for high dielectric constant type. Apply 200% of the rated DC voltage at the maximum operating temperature ±3°C for one hour. Remove and set for 24±2 hours at room temperature. Perform initial measurement.  *150% for 500V
	Appearance	No defects or abnormalities		
	Capacitance Change	Within ±3% or ±0.3pF (Whichever is larger)	B1, B3, R1, R6, R7, C8 : Within ±12.5% F1, F5, E4 : Within ±30% [Except 10V max. and. C≥1.0μF] F1, F5 : Within +30/-40% [10V max. and C≥1.0μF]	
	Q/D.F.	30pF and over : Q≥350 10pF and over : Q≥275+2.5C 10pF and below : Q≥200+10C  C : Nominal Capacitance (pF)	[B1, B3, R1, R6, R7, E4, C8] W.V. : 25V min. : 0.05 max. W.V. : 16/10V : 0.05 max. W.V. : 6.3V : 0.075 max. (C<3.3μF) : 0.125 max. (C≥3.3μF)  [F1, F5] W.V. : 25V min. : 0.075 max. (C<0.1μF) : 0.125 max. (C≥0.1μF) W.V. : 16/10V : 0.15 max. W.V. : 6.3V : 0.2 max.	
	I.R.	More than 1,000MΩ or 50Ω · F (Whichever is smaller)		

# Chip Monolithic Ceramic Capacitors



## Large Capacitance Type

### ■ Features

1. Smaller size and higher capacitance value
2. High reliability and no polarity
3. Excellent pulse responsibility and noise reduction due to the low impedance at high frequency
4. Ta replacement

### ■ Applications

General electronic equipment

Part Number	Dimensions (mm)				
	L	W	T	e min.	g min.
GRM033	0.6 ±0.03	0.3 ±0.03	0.3 ±0.03	0.1 to 0.2	0.2
GRM155	1.0 ±0.05	0.5 ±0.05	0.5 ±0.05	0.15 to 0.35	0.3
GRM185	1.6 ±0.1	0.8 ±0.1	0.5 ±0.2	0.2 to 0.5	0.5
GRM188	1.6 ±0.1	0.8 ±0.1	0.8 ±0.1	0.2 to 0.5	0.5
GRM216	2.0 ±0.1	1.25 ±0.1	0.6 ±0.1	0.2 to 0.7	0.7
GRM219			0.85 ±0.1		
GRM21B			1.25 ±0.1		
GRM316	3.2 ±0.15	1.6 ±0.15	0.6 ±0.1	0.3 to 0.8	1.5
GRM319			0.85 ±0.1		
GRM31M			1.15 ±0.1		
GRM219	3.2 ±0.2	1.6 ±0.2	1.6 ±0.2	0.3	1.0
GRM31C	3.2 ±0.2	1.6 ±0.2	1.6 ±0.2		
GRM32C	3.2 ±0.3	2.5 ±0.2	2.0 ±0.2		
GRM32D	3.2 ±0.3	2.5 ±0.2	2.0 ±0.2	0.3	2.0
GRM32E			2.5 ±0.2		
GRM43D			2.0 ±0.2		
GRM43E	4.5 ±0.4	3.2 ±0.3	2.5 ±0.2	0.3	2.0
GRM43S			2.8 ±0.2		
GRM55F	5.7 ±0.4	5.0 ±0.4	3.2 ±0.2	0.3	2.0

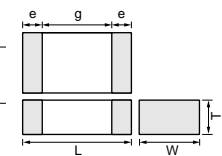

6

## High Dielectric Constant Type X5R (R6) Characteristics

Part Number	TC Code (Standard)	Rated Voltage (Vdc)	Capacitance	Length L (mm)	Width W (mm)	Thickness T (mm)
GRM188R61E474KA12	X5R (EIA)	25	0.47μF ±10%	1.60	0.80	0.80
GRM188R61E105KA12	X5R (EIA)	25	1.0μF ±10%	1.60	0.80	0.80
GRM21BR61E105KA99	X5R (EIA)	25	1.0μF ±10%	2.00	1.25	1.25
GRM219R61E225KA12	X5R (EIA)	25	2.2μF ±10%	2.00	1.25	0.85
GRM21BR61E225KA12	X5R (EIA)	25	2.2μF ±10%	2.00	1.25	1.25
GRM21BR61E335KA12	X5R (EIA)	25	3.3μF ±10%	2.00	1.25	1.25
GRM21BR61E475KA12	X5R (EIA)	25	4.7μF ±10%	2.00	1.25	1.25
GRM319R61E475KA12	X5R (EIA)	25	4.7μF ±10%	3.20	1.60	0.85
GRM31CR61E106KA12	X5R (EIA)	25	10μF ±10%	3.20	1.60	1.60
GRM32ER61E226KE15	X5R (EIA)	25	22μF ±10%	3.20	2.50	2.50
GRM188R61C474KA93	X5R (EIA)	16	0.47μF ±10%	1.60	0.80	0.80
GRM185R61C105KE44	X5R (EIA)	16	1.0μF ±10%	1.60	0.80	0.50
GRM188R61C105KA93	X5R (EIA)	16	1.0μF ±10%	1.60	0.80	0.80
GRM216R61C105KA88	X5R (EIA)	16	1.0μF ±10%	2.00	1.25	0.60
GRM188R61C225KE15	X5R (EIA)	16	2.2μF ±10%	1.60	0.80	0.80
GRM219R61C225KA88	X5R (EIA)	16	2.2μF ±10%	2.00	1.25	0.85
GRM21BR61C225KA88	X5R (EIA)	16	2.2μF ±10%	2.00	1.25	1.25
GRM316R61C225KA88	X5R (EIA)	16	2.2μF ±10%	3.20	1.60	0.60
GRM21BR61C335KA88	X5R (EIA)	16	3.3μF ±10%	2.00	1.25	1.25
GRM21BR61C475KA88	X5R (EIA)	16	4.7μF ±10%	2.00	1.25	1.25
GRM319R61C475KA88	X5R (EIA)	16	4.7μF ±10%	3.20	1.60	0.85
GRM32ER61C226KE20	X5R (EIA)	16	22μF ±10%	3.20	2.50	2.50
GRM43ER61C226KE01	X5R (EIA)	16	22μF ±10%	4.50	3.20	2.50
GRM32ER61C476KE15	X5R (EIA)	16	47μF ±10%	3.20	2.50	2.50
GRM155R61A154KE19	X5R (EIA)	10	0.15μF ±10%	1.00	0.50	0.50
GRM155R61A224KE19	X5R (EIA)	10	0.22μF ±10%	1.00	0.50	0.50
GRM185R61A105KE36	X5R (EIA)	10	1.0μF ±10%	1.60	0.80	0.50
GRM188R61A225KE34	X5R (EIA)	10	2.2μF ±10%	1.60	0.80	0.80
GRM188R61A225ME34	X5R (EIA)	10	2.2μF ±10%	1.60	0.80	0.80
GRM216R61A225KE24	X5R (EIA)	10	2.2μF ±10%	2.00	1.25	0.60
GRM219R61A225KA01	X5R (EIA)	10	2.2μF ±10%	2.00	1.25	0.85
GRM316R61A225KA01	X5R (EIA)	10	2.2μF ±10%	3.20	1.60	0.60
GRM219R61A335KE19	X5R (EIA)	10	3.3μF ±10%	2.00	1.25	0.85
GRM21BR61A335KA73	X5R (EIA)	10	3.3μF ±10%	2.00	1.25	1.25
GRM316R61A335KE19	X5R (EIA)	10	3.3μF ±10%	3.20	1.60	0.60
GRM219R61A475KE34	X5R (EIA)	10	4.7μF ±10%	2.00	1.25	0.85

Continued on the following page.

 Continued from the preceding page.

Part Number	TC Code (Standard)	Rated Voltage (Vdc)	Capacitance	Length L (mm)	Width W (mm)	Thickness T (mm)
GRM21BR61A475KA73	X5R (EIA)	10	4.7μF ±10%	2.00	1.25	1.25
GRM316R61A475KE19	X5R (EIA)	10	4.7μF ±10%	3.20	1.60	0.60
GRM319R61A475KA01	X5R (EIA)	10	4.7μF ±10%	3.20	1.60	0.85
GRM21BR61A106KE19	X5R (EIA)	10	10μF ±10%	2.00	1.25	1.25
GRM21BR61A106ME19	X5R (EIA)	10	10μF ±20%	2.00	1.25	1.25
GRM319R61A106KA19	X5R (EIA)	10	10μF ±10%	3.20	1.60	0.85
GRM31MR61A106KE19	X5R (EIA)	10	10μF ±10%	3.20	1.60	1.15
GRM32NR61A226KE19	X5R (EIA)	10	22μF ±10%	3.20	2.50	1.35
GRM32ER61A476KE20	X5R (EIA)	10	47μF ±10%	3.20	2.50	2.50
GRM43ER61A476KE19	X5R (EIA)	10	47μF ±10%	4.50	3.20	2.50
GRM033R60J153KE01	X5R (EIA)	6.3	15000pF ±10%	0.60	0.30	0.30
GRM033R60J223KE01	X5R (EIA)	6.3	22000pF ±10%	0.60	0.30	0.30
GRM033R60J333KE01	X5R (EIA)	6.3	33000pF ±10%	0.60	0.30	0.30
GRM033R60J393KE19	X5R (EIA)	6.3	39000pF ±10%	0.60	0.30	0.30
GRM033R60J473KE19	X5R (EIA)	6.3	47000pF ±10%	0.60	0.30	0.30
GRM033R60J683KE19	X5R (EIA)	6.3	68000pF ±10%	0.60	0.30	0.30
GRM033R60J104KE19	X5R (EIA)	6.3	0.10μF ±10%	0.60	0.30	0.30
GRM155R60J154KE01	X5R (EIA)	6.3	0.15μF ±10%	1.00	0.50	0.50
GRM155R60J224KE01	X5R (EIA)	6.3	0.22μF ±10%	1.00	0.50	0.50
GRM155R60J334KE01	X5R (EIA)	6.3	0.33μF ±10%	1.00	0.50	0.50
GRM155R60J474KE19	X5R (EIA)	6.3	0.47μF ±10%	1.00	0.50	0.50
GRM155R60J105KE19	X5R (EIA)	6.3	1.0μF ±10%	1.00	0.50	0.50
GRM185R60J105KE21	X5R (EIA)	6.3	1.0μF ±10%	1.60	0.80	0.50
GRM185R60J105KE26	X5R (EIA)	6.3	1.0μF ±10%	1.60	0.80	0.50
GRM185R60J225KE26	X5R (EIA)	6.3	2.2μF ±10%	1.60	0.80	0.50
GRM188R60J225KE01	X5R (EIA)	6.3	2.2μF ±10%	1.60	0.80	0.80
GRM188R60J225KE19	X5R (EIA)	6.3	2.2μF ±10%	1.60	0.80	0.80
GRM188R60J475KE19	X5R (EIA)	6.3	4.7μF ±10%	1.60	0.80	0.80
GRM219R60J475KE01	X5R (EIA)	6.3	4.7μF ±10%	2.00	1.25	0.85
GRM219R60J475KE19	X5R (EIA)	6.3	4.7μF ±10%	2.00	1.25	0.85
GRM219R60J475KE32	X5R (EIA)	6.3	4.7μF ±10%	2.00	1.25	0.85
GRM219R60J106KE19	X5R (EIA)	6.3	10μF ±10%	2.00	1.25	0.85
GRM219R60J106ME19	X5R (EIA)	6.3	10μF ±20%	2.00	1.25	0.85
GRM21BR60J106KE01	X5R (EIA)	6.3	10μF ±10%	2.00	1.25	1.25
GRM21BR60J106KE19	X5R (EIA)	6.3	10μF ±10%	2.00	1.25	1.25
GRM21BR60J106ME01	X5R (EIA)	6.3	10μF ±20%	2.00	1.25	1.25
GRM21BR60J106ME19	X5R (EIA)	6.3	10μF ±20%	2.00	1.25	1.25
GRM319R60J106KE01	X5R (EIA)	6.3	10μF ±10%	3.20	1.60	0.85
GRM319R60J106KE19	X5R (EIA)	6.3	10μF ±10%	3.20	1.60	0.85
GRM31MR60J106KE19	X5R (EIA)	6.3	10μF ±10%	3.20	1.60	1.15
GRM31CR60J156KE19	X5R (EIA)	6.3	15μF ±10%	3.20	1.60	1.60
GRM21BR60J226ME39	X5R (EIA)	6.3	22μF ±20%	2.00	1.25	1.25
GRM31CR60J226KE19	X5R (EIA)	6.3	22μF ±10%	3.20	1.60	1.60
GRM31CR60J226ME19	X5R (EIA)	6.3	22μF ±20%	3.20	1.60	1.60
GRM32DR60J226KA01	X5R (EIA)	6.3	22μF ±10%	3.20	2.50	2.00
GRM32DR60J336ME19	X5R (EIA)	6.3	33μF ±10%	3.20	2.50	2.00
GRM43DR60J336KE01	X5R (EIA)	6.3	33μF ±10%	4.50	3.20	2.00
GRM31CR60J476ME19	X5R (EIA)	6.3	47μF ±20%	3.20	1.60	1.60
GRM32ER60J476ME20	X5R (EIA)	6.3	47μF ±20%	3.20	2.50	2.50
GRM43ER60J476KE01	X5R (EIA)	6.3	47μF ±10%	4.50	3.20	2.50
GRM32ER60J107ME20	X5R (EIA)	6.3	100μF ±20%	3.20	2.50	2.50
GRM43SR60J107ME20	X5R (EIA)	6.3	100μF ±20%	4.50	3.20	2.80
GRM188R60G106ME47	X5R (EIA)	4	10μF ±20%	1.60	0.80	0.80

### High Dielectric Constant Type X6S/X7R/X7S (C8/R7/C7) Characteristics

Part Number	TC Code (Standard)	Rated Voltage (Vdc)	Capacitance (μF)	Length L (mm)	Width W (mm)	Thickness T (mm)
GRM188C80G475KE19	X6S(EIA)	4	4.7 ±10%	1.60	0.80	0.80
GRM21BR71E225KA73	X7R (EIA)	25	2.2 ±10%	2.00	1.25	1.25
GRM55ER71E156KA01	X7R (EIA)	25	15 ±10%	5.70	5.00	2.50
GRM31CR71C106KAC7	X7R (EIA)	16	10 ±10%	3.20	1.60	1.60
GRM32ER71A226KE20	X7R (EIA)	10	22 ±10%	3.20	2.50	2.50
GRM32ER71A226ME20	X7R (EIA)	10	22 ±20%	3.20	2.50	2.50
GRM43ER71A226KE01	X7R (EIA)	10	22 ±10%	4.50	3.20	2.50
GRM21BC71A335KA73	X7S(EIA)	10	3.3 ±10%	2.00	1.25	1.25
GRM21BC71A475KA73	X7S(EIA)	10	4.7 ±10%	2.00	1.25	1.25

6

### High Dielectric Constant Type Y5V (F5) Characteristics

Part Number	TC Code (Standard)	Rated Voltage (Vdc)	Capacitance (μF)	Length L (mm)	Width W (mm)	Thickness T (mm)
GRM188F51A225ZE01	Y5V (EIA)	10	2.2 +80/-20%	1.60	0.80	0.80
GRM188F51A475ZE20	Y5V (EIA)	10	4.7 +80/-20%	1.60	0.80	0.80
GRM31CF51A226ZE01	Y5V (EIA)	10	22 +80/-20%	3.20	1.60	1.60
GRM32CF51A226ZA01	Y5V (EIA)	10	22 +80/-20%	3.20	2.50	1.60
GRM155F50J105ZE01	Y5V (EIA)	6.3	1.0 +80/-20%	1.00	0.50	0.50
GRM188F50J225ZE01	Y5V (EIA)	6.3	2.2 +80/-20%	1.60	0.80	0.80
GRM188F50J475ZE20	Y5V (EIA)	6.3	4.7 +80/-20%	1.60	0.80	0.80
GRM21BF50J106ZE01	Y5V (EIA)	6.3	10 +80/-20%	2.00	1.25	1.25
GRM31CF50J226ZE01	Y5V (EIA)	6.3	22 +80/-20%	3.20	1.60	1.60
GRM32EF50J107ZE20	Y5V (EIA)	6.3	100 +80/-20%	3.20	2.50	2.50

## Specifications and Test Methods

No.	Item	Specifications	Test Method																					
1	Operating Temperature Range	B1, B3, F1 : -25 to +85°C R6 : -55 to +85°C F5 : -30 to +85°C C8 : -55 to +105°C, C7 : -55 to +125°C	Reference temperature : 25°C (B1, B3, F1 : 20°C)																					
2	Rated Voltage	See the previous pages.	The rated voltage is defined as the maximum voltage which may be applied continuously to the capacitor. When AC voltage is superimposed on DC voltage, V <sup>P-P</sup> or V <sup>O-P</sup> , whichever is larger, should be maintained within the rated voltage range.																					
3	Appearance	No defects or abnormalities	Visual inspection																					
4	Dimensions	Within the specified dimensions	Using calipers																					
5	Dielectric Strength	No defects or abnormalities	No failure should be observed when 250% of the rated voltage is applied between the terminations for 1 to 5 seconds, provided the charge/discharge current is less than 50mA.																					
6	Insulation Resistance	More than 50Ω · F	The insulation resistance should be measured with a DC voltage not exceeding the rated voltage at reference temperature and 75%RH max. and within 1 minutes of charging, provided the charge/discharge current is less than 50mA.																					
7	Capacitance	Within the specified tolerance  *Table 1 <u>GRM155 B3/R6 1A 124 to 224</u> <u>GRM185 B3/R6 1A 105</u> <u>GRM188 B3/R6 1C/1A 225</u> <u>GRM219 B3/R6 1A 475</u> <u>GRM21B B3/R6 1C/1A 106</u>	The capacitance should be measured at reference temperature at the frequency and voltage shown in the table. <table border="1" style="margin-left: auto; margin-right: auto;"><thead><tr><th>Capacitance</th><th>Frequency</th><th>Voltage</th></tr></thead><tbody><tr><td>C≤10μF (10V min.)*1</td><td>1±0.1kHz</td><td>1.0±0.2Vrms</td></tr><tr><td>C≤10μF (6.3V max.)</td><td>1±0.1kHz</td><td>0.5±0.1Vrms</td></tr><tr><td>C&gt;10μF</td><td>120±24Hz</td><td>0.5±0.1Vrms</td></tr></tbody></table> *1 However the voltage is 0.5±0.1Vrms about Table 1 items on the left side.	Capacitance	Frequency	Voltage	C≤10μF (10V min.)*1	1±0.1kHz	1.0±0.2Vrms	C≤10μF (6.3V max.)	1±0.1kHz	0.5±0.1Vrms	C>10μF	120±24Hz	0.5±0.1Vrms									
Capacitance	Frequency	Voltage																						
C≤10μF (10V min.)*1	1±0.1kHz	1.0±0.2Vrms																						
C≤10μF (6.3V max.)	1±0.1kHz	0.5±0.1Vrms																						
C>10μF	120±24Hz	0.5±0.1Vrms																						
8	Dissipation Factor (D.F.)	B1, B3, R6, C7, C8 : 0.1 max. F1, F5 : 0.2 max.  *Table 1 <u>GRM155 B3/R6 1A 124 to 224</u> <u>GRM185 B3/R6 1A 105</u> <u>GRM188 B3/R6 1C/1A 225</u> <u>GRM219 B3/R6 1A 475</u> <u>GRM21B B3/R6 1C/1A 106</u>	The D.F. should be measured at reference temperature at the frequency and voltage shown in the table. <table border="1" style="margin-left: auto; margin-right: auto;"><thead><tr><th>Capacitance</th><th>Frequency</th><th>Voltage</th></tr></thead><tbody><tr><td>C≤10μF (10V min.)*1</td><td>1±0.1kHz</td><td>1.0±0.2Vrms</td></tr><tr><td>C≤10μF (6.3V max.)</td><td>1±0.1kHz</td><td>0.5±0.1Vrms</td></tr><tr><td>C&gt;10μF</td><td>120±24Hz</td><td>0.5±0.1Vrms</td></tr></tbody></table> *1 However the voltage is 0.5±0.1Vrms about Table 1 items on the left side.	Capacitance	Frequency	Voltage	C≤10μF (10V min.)*1	1±0.1kHz	1.0±0.2Vrms	C≤10μF (6.3V max.)	1±0.1kHz	0.5±0.1Vrms	C>10μF	120±24Hz	0.5±0.1Vrms									
Capacitance	Frequency	Voltage																						
C≤10μF (10V min.)*1	1±0.1kHz	1.0±0.2Vrms																						
C≤10μF (6.3V max.)	1±0.1kHz	0.5±0.1Vrms																						
C>10μF	120±24Hz	0.5±0.1Vrms																						
9	No bias	B1, B3 : Within ±10% (-25 to +85°C) F1 : Within +30/-80% (-25 to +85°C) R6 : Within ±15% (-55 to +85°C) F5 : Within +22/-82% (-30 to +85°C) C7 : Within ±22% (-55 to +125°C) C8 : Within ±22% (-55 to +105°C)	The capacitance change should be measured after 5 min. at each specified temp. stage. The ranges of capacitance change compared with the reference temperature value over the temperature ranges shown in the table should be within the specified ranges.* In case of applying voltage, the capacitance change should be measured after 1 more min. with applying voltage in equilibration of each temp. stage.  *GRM43 B1/R6 0J/1A 336/476 only : 1.0±0.2Vrms <table border="1" style="margin-left: auto; margin-right: auto;"><thead><tr><th>Step</th><th>Temperature (°C)</th><th>Applying Voltage (V)</th></tr></thead><tbody><tr><td>1</td><td>Reference temperature ±2</td><td rowspan="3">No bias</td></tr><tr><td>2</td><td>-55±3 (for R6, C7, C8)/ -25±3 (for B1, B3, F1) -30±3 (for F5)</td></tr><tr><td>3</td><td>Reference temperature ±2</td></tr><tr><td>4</td><td>85±3 (for B1, B3, F1, R6, F5) 125±3 (for C7)/ 105±3 (for C8)</td><td rowspan="5">50% of the rated voltage</td></tr><tr><td>5</td><td>20±2</td></tr><tr><td>6</td><td>-25±3 (for B1, F1)</td></tr><tr><td>7</td><td>20±2</td></tr><tr><td>8</td><td>85±3 (for B1, F1)</td></tr></tbody></table> •Initial measurement for high dielectric constant type Perform a heat treatment at 150 +0/-10°C for one hour and then set for 24±2 hours at room temperature. Perform the initial measurement.	Step	Temperature (°C)	Applying Voltage (V)	1	Reference temperature ±2	No bias	2	-55±3 (for R6, C7, C8)/ -25±3 (for B1, B3, F1) -30±3 (for F5)	3	Reference temperature ±2	4	85±3 (for B1, B3, F1, R6, F5) 125±3 (for C7)/ 105±3 (for C8)	50% of the rated voltage	5	20±2	6	-25±3 (for B1, F1)	7	20±2	8	85±3 (for B1, F1)
	Step	Temperature (°C)		Applying Voltage (V)																				
1	Reference temperature ±2	No bias																						
2	-55±3 (for R6, C7, C8)/ -25±3 (for B1, B3, F1) -30±3 (for F5)																							
3	Reference temperature ±2																							
4	85±3 (for B1, B3, F1, R6, F5) 125±3 (for C7)/ 105±3 (for C8)	50% of the rated voltage																						
5	20±2																							
6	-25±3 (for B1, F1)																							
7	20±2																							
8	85±3 (for B1, F1)																							
50% of the Rated Voltage	B1: Within +10/-30% F1: Within +30/-95%																							

Continued on the following page.

6

## Specifications and Test Methods

Continued from the preceding page.

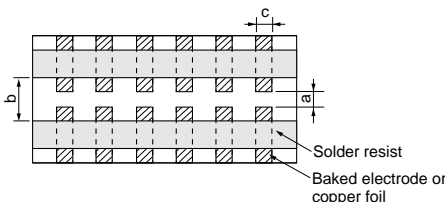
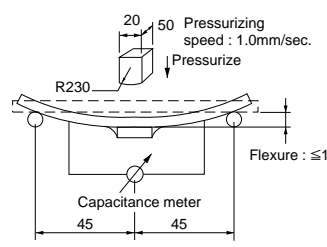
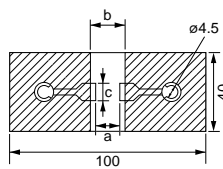
No.	Item	Specifications	Test Method																																				
10	Adhesive Strength of Termination	No removal of the terminations or other defects should occur.	<p>Solder the capacitor on the test jig (glass epoxy board) shown in Fig. 1a using an eutectic solder. Then apply 10N* force in parallel with the test jig for 10±1sec.</p> <p>The soldering should be done either with an iron or using the reflow method and should be conducted with care so that the soldering is uniform and free of defects such as heat shock.</p> <p>*5N : GR□15/GRM18, 2N : GR□33</p> <table border="1"> <thead> <tr> <th>Type</th> <th>a</th> <th>b</th> <th>c</th> </tr> </thead> <tbody> <tr> <td>GR□03</td> <td>0.3</td> <td>0.9</td> <td>0.3</td> </tr> <tr> <td>GR□15</td> <td>0.4</td> <td>1.5</td> <td>0.5</td> </tr> <tr> <td>GRM18</td> <td>1.0</td> <td>3.0</td> <td>1.2</td> </tr> <tr> <td>GRM21</td> <td>1.2</td> <td>4.0</td> <td>1.65</td> </tr> <tr> <td>GRM31</td> <td>2.2</td> <td>5.0</td> <td>2.0</td> </tr> <tr> <td>GRM32</td> <td>2.2</td> <td>5.0</td> <td>2.9</td> </tr> <tr> <td>GRM43</td> <td>3.5</td> <td>7.0</td> <td>3.7</td> </tr> <tr> <td>GRM55</td> <td>4.5</td> <td>8.0</td> <td>5.6</td> </tr> </tbody> </table>	Type	a	b	c	GR□03	0.3	0.9	0.3	GR□15	0.4	1.5	0.5	GRM18	1.0	3.0	1.2	GRM21	1.2	4.0	1.65	GRM31	2.2	5.0	2.0	GRM32	2.2	5.0	2.9	GRM43	3.5	7.0	3.7	GRM55	4.5	8.0	5.6
		Type		a	b	c																																	
GR□03	0.3	0.9	0.3																																				
GR□15	0.4	1.5	0.5																																				
GRM18	1.0	3.0	1.2																																				
GRM21	1.2	4.0	1.65																																				
GRM31	2.2	5.0	2.0																																				
GRM32	2.2	5.0	2.9																																				
GRM43	3.5	7.0	3.7																																				
GRM55	4.5	8.0	5.6																																				
 <p>Fig. 1a</p>																																							
11	Vibration	Appearance	No defects or abnormalities																																				
		Capacitance	Within the specified tolerance																																				
		D.F.	B1, B3, R6, C7, C8 : 0.1 max. F1, F5 : 0.2 max.																																				
12	Deflection	No cracking or marking defects should occur.	<p>Solder the capacitor on the test jig (glass epoxy board) shown in Fig. 2a using an eutectic solder. Then apply a force in the direction shown in Fig. 3a for 5±1 sec. The soldering should be done either with an iron or using the reflow method and should be conducted with care so that the soldering is uniform and free of defects such as heat shock.</p> <table border="1"> <thead> <tr> <th>Type</th> <th>a</th> <th>b</th> <th>c</th> </tr> </thead> <tbody> <tr> <td>GR□03</td> <td>0.3</td> <td>0.9</td> <td>0.3</td> </tr> <tr> <td>GR□15</td> <td>0.4</td> <td>1.5</td> <td>0.5</td> </tr> <tr> <td>GRM18</td> <td>1.0</td> <td>3.0</td> <td>1.2</td> </tr> <tr> <td>GRM21</td> <td>1.2</td> <td>4.0</td> <td>1.65</td> </tr> <tr> <td>GRM31</td> <td>2.2</td> <td>5.0</td> <td>2.0</td> </tr> <tr> <td>GRM32</td> <td>2.2</td> <td>5.0</td> <td>2.9</td> </tr> <tr> <td>GRM43</td> <td>3.5</td> <td>7.0</td> <td>3.7</td> </tr> <tr> <td>GRM55</td> <td>4.5</td> <td>8.0</td> <td>5.6</td> </tr> </tbody> </table> <p>(in mm)</p>	Type	a	b	c	GR□03	0.3	0.9	0.3	GR□15	0.4	1.5	0.5	GRM18	1.0	3.0	1.2	GRM21	1.2	4.0	1.65	GRM31	2.2	5.0	2.0	GRM32	2.2	5.0	2.9	GRM43	3.5	7.0	3.7	GRM55	4.5	8.0	5.6
		Type		a	b	c																																	
GR□03	0.3	0.9	0.3																																				
GR□15	0.4	1.5	0.5																																				
GRM18	1.0	3.0	1.2																																				
GRM21	1.2	4.0	1.65																																				
GRM31	2.2	5.0	2.0																																				
GRM32	2.2	5.0	2.9																																				
GRM43	3.5	7.0	3.7																																				
GRM55	4.5	8.0	5.6																																				
 <p>Fig.3a</p>																																							
13	Solderability of Termination	75% of the terminations is to be soldered evenly and continuously.	<p>Immerse the capacitor in a solution of ethanol (JIS-K-8101) and rosin (JIS-K-5902) (25% rosin in weight proportion) .</p> <p>Preheat at 80 to 120°C for 10 to 30 seconds.</p> <p>After preheating, immerse in an eutectic solder solution for 2±0.5 seconds at 230±5°C or Sn-3.0Ag-0.5Cu solder solution for 2±0.5 seconds at 245±5°C.</p>																																				
				 <p>Fig. 2a</p> <p>t : 1.6mm</p> <p>(GR□03, GR□15 : t : 0.8mm)</p>																																			

Continued on the following page. ↗

## Specifications and Test Methods

Continued from the preceding page.

No.	Item	Specifications	Test Method															
14	Resistance to Soldering Heat	Appearance	No defects or abnormalities															
		Capacitance Change	B1, B3, R6, C7, C8 : Within $\pm 7.5\%$ F1, F5 : Within $\pm 20\%$															
		Q/D.F.	B1, B3, R6, C7, C8 : 0.1 max. F1, F5 : 0.2 max.															
		I.R.	More than $50\Omega \cdot F$															
		Dielectric Strength	No defects															
			<p>Preheat the capacitor at 120 to 150°C for 1 minute.                      Immerse the capacitor in an eutectic solder or Sn-3.0Ag-0.5Cu solder solution at 270<math>\pm</math>5°C for 10<math>\pm</math>0.5 seconds. Set at room temperature for 24<math>\pm</math>2 hours, then measure.</p> <p>•Initial measurement for high dielectric constant type                      Perform a heat treatment at 150+0/−10°C for one hour and then set at room temperature for 24<math>\pm</math>2 hours.                      Perform the initial measurement.</p> <p>*Preheating for GRM32/43/55</p> <table border="1" style="margin-left: auto; margin-right: auto;"> <thead> <tr> <th>Step</th> <th>Temperature</th> <th>Time</th> </tr> </thead> <tbody> <tr> <td>1</td> <td>100 to 120°C</td> <td>1 min.</td> </tr> <tr> <td>2</td> <td>170 to 200°C</td> <td>1 min.</td> </tr> </tbody> </table>	Step	Temperature	Time	1	100 to 120°C	1 min.	2	170 to 200°C	1 min.						
Step	Temperature	Time																
1	100 to 120°C	1 min.																
2	170 to 200°C	1 min.																
15	Temperature Sudden Change	Appearance	No defects or abnormalities															
		Capacitance Change	B1, B3, R6, C7, C8 : Within $\pm 7.5\%$ F1, F5 : Within $\pm 20\%$															
		D.F.	B1, B3, R6, C7, C8 : 0.1 max. F1, F5 : 0.2 max.															
		I.R.	More than $50\Omega \cdot F$															
		Dielectric Strength	No defects															
			<p>Fix the capacitor to the supporting jig in the same manner and under the same conditions as (10).                      Perform the five cycles according to the four heat treatments shown in the following table.                      Set for 24<math>\pm</math>2 hours at room temperature, then measure.</p> <table border="1" style="margin-left: auto; margin-right: auto;"> <thead> <tr> <th>Step</th> <th>1</th> <th>2</th> <th>3</th> <th>4</th> </tr> </thead> <tbody> <tr> <td>Temp. (°C)</td> <td>Min. Operating Temp. +0/−3</td> <td>Room Temp.</td> <td>Max. Operating Temp. +3/−0</td> <td>Room Temp.</td> </tr> <tr> <td>Time (min.)</td> <td>30<math>\pm</math>3</td> <td>2 to 3</td> <td>30<math>\pm</math>3</td> <td>2 to 3</td> </tr> </tbody> </table> <p>•Initial measurement for high dielectric constant type                      Perform a heat treatment at 150+0/−10°C for one hour and then set at room temperature for 24<math>\pm</math>2 hours.                      Perform the initial measurement.</p>	Step	1	2	3	4	Temp. (°C)	Min. Operating Temp. +0/−3	Room Temp.	Max. Operating Temp. +3/−0	Room Temp.	Time (min.)	30 $\pm$ 3	2 to 3	30 $\pm$ 3	2 to 3
Step	1	2	3	4														
Temp. (°C)	Min. Operating Temp. +0/−3	Room Temp.	Max. Operating Temp. +3/−0	Room Temp.														
Time (min.)	30 $\pm$ 3	2 to 3	30 $\pm$ 3	2 to 3														
16	High Temperature High Humidity (Steady)	Appearance	No defects or abnormalities															
		Capacitance Change	B1, B3, R6, C7, C8 : Within $\pm 12.5\%$ F1, F5 : Within $\pm 30\%$															
		D.F.	B1, B3, R6, C7, C8 : 0.2 max. F1, F5 : 0.4 max.															
		I.R.	More than $12.5\Omega \cdot F$															
			<p>Apply the rated voltage at 40<math>\pm</math>2°C and 90 to 95% humidity for 500<math>\pm</math>12 hours. The charge/discharge current is less than 50mA.</p> <p>•Initial measurement                      Perform a heat treatment at 150+0/−10°C for one hour and then let sit for 24<math>\pm</math>2 hours at room temperature. Perform the initial measurement.</p> <p>•Measurement after test                      Perform a heat treatment at 150+0/−10°C for one hour and then let sit for 24<math>\pm</math>2 hours at room temperature, then measure.</p>															
17	Durability	Appearance	No defects or abnormalities															
		Capacitance Change	B1, B3, R6, C7, C8 : Within $\pm 12.5\%$ F1, F5 : Within $\pm 30\%$															
		D.F.	B1, B3, R6, C7, C8 : 0.1 max. F1, F5 : 0.4 max.															
		I.R.	More than $25\Omega \cdot F$															
			<p>Apply 150% of the rated voltage for 1000<math>\pm</math>12 hours at the maximum operating temperature <math>\pm 3^\circ\text{C}</math>. Let sit for 24<math>\pm</math>2 hours at room temperature, then measure.                      The charge/discharge current is less than 50mA.</p> <p>•Initial measurement                      Perform a heat treatment at 150+0/−10°C for one hour and then let sit for 24<math>\pm</math>2 hours at room temperature. Perform the initial measurement.</p> <p>•Measurement after test                      Perform a heat treatment at 150+0/−10°C for one hour and then let sit for 24<math>\pm</math>2 hours at room temperature, then measure.</p>															

6

# Chip Monolithic Ceramic Capacitors



## High-Q GJM Series

### ■ Features

1. Mobile Telecommunication and RF module, mainly
2. Quality improvement of telephone call, Low power Consumption, yield ratio improvement

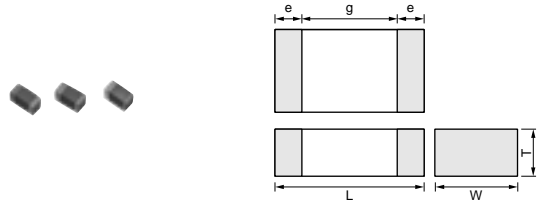

### ■ Applications

VCO, PA, Mobile Telecommunication

Part Number	Dimensions (mm)				
	L	W	T	e	g min.
<b>GJM03</b>	0.6 ±0.03	0.3 ±0.03	0.3 ±0.03	0.1 to 0.2	0.2
<b>GJM15</b>	1.0 ±0.05	0.5 ±0.05	0.5 ±0.05	0.15 to 0.3	0.4

7

Part Number	<b>GJM03</b>	<b>GJM15</b>
L x W [EIA]	0.60x0.30 [0201]	1.00x0.50 [0402]
TC	COG <b>(5C)</b>	COG <b>(5C)</b>
Rated Volt.	25 <b>(1E)</b>	50 <b>(1H)</b>
Capacitance (Capacitance part numbering code) and T (mm) Dimension (T Dimension part numbering code)		
0.30pF( <b>R30</b> )	0.30( <b>3</b> )	0.50( <b>5</b> )
0.40pF( <b>R40</b> )	0.30( <b>3</b> )	0.50( <b>5</b> )
0.50pF( <b>R50</b> )	0.30( <b>3</b> )	0.50( <b>5</b> )
0.60pF( <b>R60</b> )	0.30( <b>3</b> )	0.50( <b>5</b> )
0.70pF( <b>R70</b> )	0.30( <b>3</b> )	0.50( <b>5</b> )
0.75pF( <b>R75</b> )	0.30( <b>3</b> )	0.50( <b>5</b> )
0.80pF( <b>R80</b> )	0.30( <b>3</b> )	0.50( <b>5</b> )
0.90pF( <b>R90</b> )	0.30( <b>3</b> )	0.50( <b>5</b> )
1.0pF( <b>1R0</b> )	0.30( <b>3</b> )	0.50( <b>5</b> )
1.1pF( <b>1R1</b> )	0.30( <b>3</b> )	0.50( <b>5</b> )
1.2pF( <b>1R2</b> )	0.30( <b>3</b> )	0.50( <b>5</b> )
1.3pF( <b>1R3</b> )	0.30( <b>3</b> )	0.50( <b>5</b> )
1.4pF( <b>1R4</b> )	0.30( <b>3</b> )	0.50( <b>5</b> )
1.5pF( <b>1R5</b> )	0.30( <b>3</b> )	0.50( <b>5</b> )
1.6pF( <b>1R6</b> )	0.30( <b>3</b> )	0.50( <b>5</b> )
1.7pF( <b>1R7</b> )	0.30( <b>3</b> )	0.50( <b>5</b> )
1.8pF( <b>1R8</b> )	0.30( <b>3</b> )	0.50( <b>5</b> )
1.9pF( <b>1R9</b> )	0.30( <b>3</b> )	0.50( <b>5</b> )
2.0pF( <b>2R0</b> )	0.30( <b>3</b> )	0.50( <b>5</b> )
2.1pF( <b>2R1</b> )	0.30( <b>3</b> )	0.50( <b>5</b> )
2.2pF( <b>2R2</b> )	0.30( <b>3</b> )	0.50( <b>5</b> )
2.3pF( <b>2R3</b> )	0.30( <b>3</b> )	0.50( <b>5</b> )
2.4pF( <b>2R4</b> )	0.30( <b>3</b> )	0.50( <b>5</b> )
2.5pF( <b>2R5</b> )	0.30( <b>3</b> )	0.50( <b>5</b> )
2.6pF( <b>2R6</b> )	0.30( <b>3</b> )	0.50( <b>5</b> )
2.7pF( <b>2R7</b> )	0.30( <b>3</b> )	0.50( <b>5</b> )
2.8pF( <b>2R8</b> )	0.30( <b>3</b> )	0.50( <b>5</b> )
2.9pF( <b>2R9</b> )	0.30( <b>3</b> )	0.50( <b>5</b> )
3.0pF( <b>3R0</b> )	0.30( <b>3</b> )	0.50( <b>5</b> )
3.1pF( <b>3R1</b> )	0.30( <b>3</b> )	0.50( <b>5</b> )
3.2pF( <b>3R2</b> )	0.30( <b>3</b> )	0.50( <b>5</b> )
3.3pF( <b>3R3</b> )	0.30( <b>3</b> )	0.50( <b>5</b> )
3.4pF( <b>3R4</b> )	0.30( <b>3</b> )	0.50( <b>5</b> )

Continued on the following page.





 Continued from the preceding page.

Part Number	GJM03	GJM15
L x W [EIA]	0.60x0.30 [0201]	1.00x0.50 [0402]
TC	COG (5C)	COG (5C)
Rated Volt.	25 (1E)	50 (1H)
Capacitance (Capacitance part numbering code) and T (mm) Dimension (T Dimension part numbering code)		
3.5pF(3R5)	0.30(3)	0.50(5)
3.6pF(3R6)	0.30(3)	0.50(5)
3.7pF(3R7)	0.30(3)	0.50(5)
3.8pF(3R8)	0.30(3)	0.50(5)
3.9pF(3R9)	0.30(3)	0.50(5)
4.0pF(4R0)	0.30(3)	0.50(5)
4.1pF(4R1)	0.30(3)	0.50(5)
4.2pF(4R2)	0.30(3)	0.50(5)
4.3pF(4R3)	0.30(3)	0.50(5)
4.4pF(4R4)	0.30(3)	0.50(5)
4.5pF(4R5)	0.30(3)	0.50(5)
4.6pF(4R6)	0.30(3)	0.50(5)
4.7pF(4R7)	0.30(3)	0.50(5)
4.8pF(4R8)	0.30(3)	0.50(5)
4.9pF(4R9)	0.30(3)	0.50(5)
5.0pF(5R0)	0.30(3)	0.50(5)
5.1pF(5R1)	0.30(3)	0.50(5)
5.2pF(5R2)	0.30(3)	0.50(5)
5.3pF(5R3)	0.30(3)	0.50(5)
5.4pF(5R4)	0.30(3)	0.50(5)
5.5pF(5R5)	0.30(3)	0.50(5)
5.6pF(5R6)	0.30(3)	0.50(5)
5.7pF(5R7)	0.30(3)	0.50(5)
5.8pF(5R8)	0.30(3)	0.50(5)
5.9pF(5R9)	0.30(3)	0.50(5)
6.0pF(6R0)	0.30(3)	0.50(5)
6.1pF(6R1)	0.30(3)	0.50(5)
6.2pF(6R2)	0.30(3)	0.50(5)
6.3pF(6R3)	0.30(3)	0.50(5)
6.4pF(6R4)	0.30(3)	0.50(5)
6.5pF(6R5)	0.30(3)	0.50(5)
6.6pF(6R6)	0.30(3)	0.50(5)
6.7pF(6R7)	0.30(3)	0.50(5)
6.8pF(6R8)	0.30(3)	0.50(5)
6.9pF(6R9)		0.50(5)
7.0pF(7R0)		0.50(5)
7.1pF(7R1)		0.50(5)
7.2pF(7R2)		0.50(5)
7.3pF(7R3)		0.50(5)
7.4pF(7R4)		0.50(5)
7.5pF(7R5)		0.50(5)
7.6pF(7R6)		0.50(5)
7.7pF(7R7)		0.50(5)
7.8pF(7R8)		0.50(5)
7.9pF(7R9)		0.50(5)
8.0pF(8R0)		0.50(5)
8.1pF(8R1)		0.50(5)
8.2pF(8R2)		0.50(5)
8.3pF(8R3)		0.50(5)
8.4pF(8R4)		0.50(5)
8.5pF(8R5)		0.50(5)
8.6pF(8R6)		0.50(5)

Continued on the following page. 

Continued from the preceding page.

Part Number	GJM03	GJM15
L x W [EIA]	0.60x0.30 [0201]	1.00x0.50 [0402]
TC	COG (5C)	COG (5C)
Rated Volt.	25 (1E)	50 (1H)
Capacitance (Capacitance part numbering code) and T (mm) Dimension (T Dimension part numbering code)		
8.7pF(8R7)		0.50(5)
8.8pF(8R8)		0.50(5)
8.9pF(8R9)		0.50(5)
9.0pF(9R0)		0.50(5)
9.1pF(9R1)		0.50(5)
9.2pF(9R2)		0.50(5)
9.3pF(9R3)		0.50(5)
9.4pF(9R4)		0.50(5)
9.5pF(9R5)		0.50(5)
9.6pF(9R6)		0.50(5)
9.7pF(9R7)		0.50(5)
9.8pF(9R8)		0.50(5)
9.9pF(9R9)		0.50(5)
10pF(100)		0.50(5)
12pF(120)		0.50(5)
15pF(150)		0.50(5)
18pF(180)		0.50(5)
20pF(200)		0.50(5)

The part numbering code is shown in ( ).  
 Dimensions are shown in mm and Rated Voltage in Vdc.

7

# Chip Monolithic Ceramic Capacitors



## Tight Tolerance High-Q GJM Series

### ■ Features

1. Mobile Telecommunication and RF module, mainly
2. Quality improvement of telephone call, Low power Consumption, yield ratio improvement

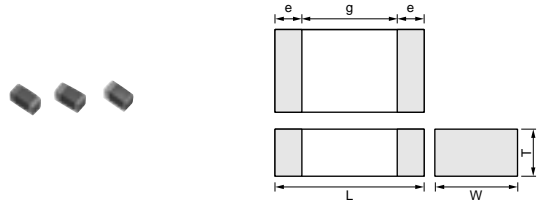

### ■ Applications

VCO, PA, Mobile Telecommunication

Part Number	Dimensions (mm)				
	L	W	T	e	g min.
<b>GJM03</b>	0.6 ±0.03	0.3 ±0.03	0.3 ±0.03	0.1 to 0.2	0.2
<b>GJM15</b>	1.0 ±0.05	0.5 ±0.05	0.5 ±0.05	0.15 to 0.3	0.4

Part Number	<b>GJM03</b>		<b>GJM15</b>	
L x W [EIA]	0.60x0.30 [0201]		1.00x0.50 [0402]	
TC	COG (5C)		COG (5C)	
Rated Volt.	25 (1E)		50 (1H)	
Capacitance, Capacitance Tolerance and T Dimension				
0.20pF(R20)	M, N	0.30(3)	0.50(5)	
0.30pF(R30)	K, M	0.30(3)	0.50(5)	
0.40pF(R40)	K, M	0.30(3)	0.50(5)	
0.50pF(R50)	K, M	0.30(3)	0.50(5)	
0.60pF(R60)	K, M	0.30(3)	0.50(5)	
0.70pF(R70)	K, M	0.30(3)	0.50(5)	
0.80pF(R80)	K, M	0.30(3)	0.50(5)	
0.90pF(R90)	K, M	0.30(3)	0.50(5)	
1.0pF(1R0)	K, M	0.30(3)	0.50(5)	
1.1pF(1R1)	K, M	0.30(3)	0.50(5)	
1.2pF(1R2)	K, M	0.30(3)	0.50(5)	
1.3pF(1R3)	K, M	0.30(3)	0.50(5)	
1.4pF(1R4)	K, M	0.30(3)	0.50(5)	
1.5pF(1R5)	K, M	0.30(3)	0.50(5)	
1.6pF(1R6)	K, M	0.30(3)	0.50(5)	
1.7pF(1R7)	K, M	0.30(3)	0.50(5)	
1.8pF(1R8)	K, M	0.30(3)	0.50(5)	
1.9pF(1R9)	K, M	0.30(3)	0.50(5)	
2.0pF(2R0)	G, J	0.30(3)	0.50(5)	
2.1pF(2R1)	G, J	0.30(3)	0.50(5)	
2.2pF(2R2)	G, J	0.30(3)	0.50(5)	
2.3pF(2R3)	G, J	0.30(3)	0.50(5)	
2.4pF(2R4)	G, J	0.30(3)	0.50(5)	
2.5pF(2R5)	G, J	0.30(3)	0.50(5)	
2.6pF(2R6)	G, J	0.30(3)	0.50(5)	
2.7pF(2R7)	G, J	0.30(3)	0.50(5)	
2.8pF(2R8)	G, J	0.30(3)	0.50(5)	
2.9pF(2R9)	G, J	0.30(3)	0.50(5)	
3.0pF(3R0)	G, J	0.30(3)	0.50(5)	
3.1pF(3R1)	G, J	0.30(3)	0.50(5)	
3.2pF(3R2)	G, J	0.30(3)	0.50(5)	
3.3pF(3R3)	G, J	0.30(3)	0.50(5)	
3.4pF(3R4)	G, J	0.30(3)	0.50(5)	

Continued on the following page.

 Continued from the preceding page.

Part Number	GJM03		GJM15	
L x W [EIA]	0.60x0.30 [0201]		1.00x0.50 [0402]	
TC	COG (5C)		COG (5C)	
Rated Volt.	25 (1E)		50 (1H)	
Capacitance, Capacitance Tolerance and T Dimension				
3.5pF(3R5)	G, J	0.30(3)	0.50(5)	
3.6pF(3R6)	G, J	0.30(3)	0.50(5)	
3.7pF(3R7)	G, J	0.30(3)	0.50(5)	
3.8pF(3R8)	G, J	0.30(3)	0.50(5)	
3.9pF(3R9)	G, J	0.30(3)	0.50(5)	
4.0pF(4R0)	G, J	0.30(3)	0.50(5)	
4.1pF(4R1)	G, J	0.30(3)	0.50(5)	
4.2pF(4R2)	G, J	0.30(3)	0.50(5)	
4.3pF(4R3)	G, J	0.30(3)	0.50(5)	
4.4pF(4R4)	G, J	0.30(3)	0.50(5)	
4.5pF(4R5)	G, J	0.30(3)	0.50(5)	
4.6pF(4R6)	G, J	0.30(3)	0.50(5)	
4.7pF(4R7)	G, J	0.30(3)	0.50(5)	
4.8pF(4R8)	G, J	0.30(3)	0.50(5)	
4.9pF(4R9)	G, J	0.30(3)	0.50(5)	
5.0pF(5R0)	F, G	0.30(3)	0.50(5)	
5.1pF(5R1)	F, G	0.30(3)	0.50(5)	
5.2pF(5R2)	F, G	0.30(3)	0.50(5)	
5.3pF(5R3)	F, G	0.30(3)	0.50(5)	
5.4pF(5R4)	F, G	0.30(3)	0.50(5)	
5.5pF(5R5)	F, G	0.30(3)	0.50(5)	
5.6pF(5R6)	F, G	0.30(3)	0.50(5)	
5.7pF(5R7)	F, G	0.30(3)	0.50(5)	
5.8pF(5R8)	F, G	0.30(3)	0.50(5)	
5.9pF(5R9)	F, G	0.30(3)	0.50(5)	
6.0pF(6R0)	F, G	0.30(3)	0.50(5)	
6.1pF(6R1)	F, G	0.30(3)	0.50(5)	
6.2pF(6R2)	F, G	0.30(3)	0.50(5)	
6.3pF(6R3)	F, G	0.30(3)	0.50(5)	
6.4pF(6R4)	F, G	0.30(3)	0.50(5)	
6.5pF(6R5)	F, G	0.30(3)	0.50(5)	
6.6pF(6R6)	F, G	0.30(3)	0.50(5)	
6.7pF(6R7)	F, G	0.30(3)	0.50(5)	
6.8pF(6R8)	F, G	0.30(3)	0.50(5)	
6.9pF(6R9)	F, G		0.50(5)	
7.0pF(7R0)	F, G		0.50(5)	
7.1pF(7R1)	F, G		0.50(5)	
7.2pF(7R2)	F, G		0.50(5)	
7.3pF(7R3)	F, G		0.50(5)	
7.4pF(7R4)	F, G		0.50(5)	
7.5pF(7R5)	F, G		0.50(5)	
7.6pF(7R6)	F, G		0.50(5)	
7.7pF(7R7)	F, G		0.50(5)	
7.8pF(7R8)	F, G		0.50(5)	
7.9pF(7R9)	F, G		0.50(5)	
8.0pF(8R0)	F, G		0.50(5)	
8.1pF(8R1)	F, G		0.50(5)	
8.2pF(8R2)	F, G		0.50(5)	
8.3pF(8R3)	F, G		0.50(5)	
8.4pF(8R4)	F, G		0.50(5)	
8.5pF(8R5)	F, G		0.50(5)	
8.6pF(8R6)	F, G		0.50(5)	

Continued on the following page. 

Continued from the preceding page.

Part Number	<b>GJM03</b>		<b>GJM15</b>	
L x W [EIA]	0.60x0.30 [0201]		1.00x0.50 [0402]	
TC	COG (5C)		COG (5C)	
Rated Volt.	25 (1E)		50 (1H)	
<b>Capacitance, Capacitance Tolerance and T Dimension</b>				
8.7pF(8R7)	<b>F, G</b>		0.50(5)	
8.8pF(8R8)	<b>F, G</b>		0.50(5)	
8.9pF(8R9)	<b>F, G</b>		0.50(5)	
9.0pF(9R0)	<b>F, G</b>		0.50(5)	
9.1pF(9R1)	<b>F, G</b>		0.50(5)	
9.2pF(9R2)	<b>F, G</b>		0.50(5)	
9.3pF(9R3)	<b>F, G</b>		0.50(5)	
9.4pF(9R4)	<b>F, G</b>		0.50(5)	
9.5pF(9R5)	<b>F, G</b>		0.50(5)	
9.6pF(9R6)	<b>F, G</b>		0.50(5)	
9.7pF(9R7)	<b>F, G</b>		0.50(5)	
9.8pF(9R8)	<b>F, G</b>		0.50(5)	
9.9pF(9R9)	<b>F, G</b>		0.50(5)	

The part numbering code is shown in ( ).  
 Dimensions are shown in mm and Rated Voltage in Vdc.

## Specifications and Test Methods

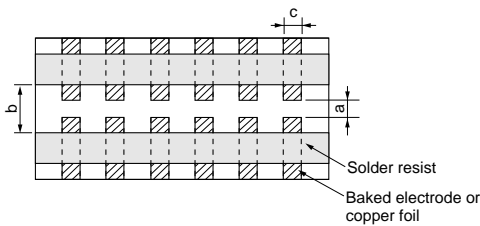
No.	Item	Specifications		Test Method												
		Temperature Compensating Type														
1	Operating Temperature Range	-55 to +125°C		Reference Temperature : 25°C (2C, 3C, 4C : 20°C)												
2	Rated Voltage	See the previous pages.		The rated voltage is defined as the maximum voltage which may be applied continuously to the capacitor. When AC voltage is superimposed on DC voltage, $V^{P-P}$ or $V^{O-P}$ , whichever is larger, should be maintained within the rated voltage range.												
3	Appearance	No defects or abnormalities		Visual inspection												
4	Dimensions	Within the specified dimensions		Using calipers												
5	Dielectric Strength	No defects or abnormalities		No failure should be observed when 300% of the rated voltage is applied between the terminations for 1 to 5 seconds, provided the charge/discharge current is less than 50mA.												
6	Insulation Resistance (I.R.)	10,000MΩ min. or 500Ω · F min. (Whichever is smaller)		The insulation resistance should be measured with a DC voltage not exceeding the rated voltage at 25°C and 75%RH max. and within 2 minutes of charging.												
7	Capacitance	Within the specified tolerance		The capacitance/Q should be measured at 25°C at the frequency and voltage shown in the table.												
8	Q	30pF max. : $Q \geq 400 + 20C$ C : Nominal Capacitance (pF)		<table border="1"> <tr> <td>Frequency</td> <td>1±0.1MHz</td> </tr> <tr> <td>Voltage</td> <td>0.5 to 5Vrms</td> </tr> </table>	Frequency	1±0.1MHz	Voltage	0.5 to 5Vrms								
		Frequency	1±0.1MHz													
Voltage	0.5 to 5Vrms															
9	Capacitance Temperature Characteristics	Capacitance Change	Within the specified tolerance (Table A)	The capacitance change should be measured after 5 min. at each specified temperature stage. Temperature Compensating Type The temperature coefficient is determined using the capacitance measured in step 3 as a reference. When cycling the temperature sequentially from step 1 through 5, (5C : +25 to 125°C : other temp. coeffs. : +20 to 125°C) the capacitance should be within the specified tolerance for the temperature coefficient and capacitance change as Table A. The capacitance drift is calculated by dividing the differences between the maximum and minimum measured values in steps 1, 3 and 5 by the capacitance value in step 3.												
		Temperature Coefficient	Within the specified tolerance (Table A)													
		Capacitance Drift	Within ±0.2% or ±0.05pF (Whichever is larger.)													
10	Adhesive Strength of Termination	No removal of the terminations or other defect should occur.		Solder the capacitor to the test jig (glass epoxy board) shown in Fig. 1 using a eutectic solder. Then apply a 5N* force in parallel with the test jig for 10±1 sec. The soldering should be done either with an iron or using the reflow method and should be conducted with care so that the soldering is uniform and free of defects such as heat shock. <p style="text-align: right;">*2N (GJM03)</p>  <table border="1"> <thead> <tr> <th>Type</th> <th>a</th> <th>b</th> <th>c</th> </tr> </thead> <tbody> <tr> <td>GJM03</td> <td>0.3</td> <td>0.9</td> <td>0.3</td> </tr> <tr> <td>GJM15</td> <td>0.4</td> <td>1.5</td> <td>0.5</td> </tr> </tbody> </table> <p style="text-align: right;">(in mm)</p>	Type	a	b	c	GJM03	0.3	0.9	0.3	GJM15	0.4	1.5	0.5
		Type	a	b	c											
GJM03	0.3	0.9	0.3													
GJM15	0.4	1.5	0.5													
				Fig. 1												

Continued on the following page. 

## Specifications and Test Methods

Continued from the preceding page.

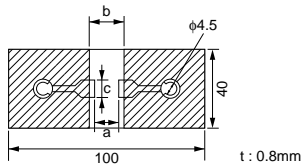
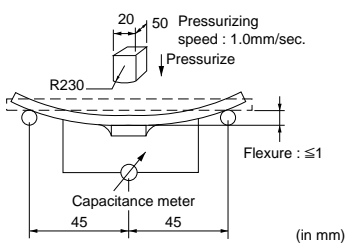
No.	Item	Specifications		Test Method															
		Temperature Compensating Type																	
11	Vibration Resistance	Appearance	No defects or abnormalities	Solder the capacitor to the test jig (glass epoxy board) in the same manner and under the same conditions as (10). The capacitor should be subjected to a simple harmonic motion having a total amplitude of 1.5mm, the frequency being varied uniformly between the approximate limits of 10 and 55Hz. The frequency range, from 10 to 55Hz and return to 10Hz, should be traversed in approximately 1 minute. This motion should be applied for a period of 2 hours in each of 3 mutually perpendicular directions (total of 6 hours).															
		Capacitance	Within the specified tolerance																
		Q	$Q \geq 400 + 20C$ C : Nominal Capacitance (pF)																
12	Deflection	No cracking or marking defects should occur.		Solder the capacitor to the test jig (glass epoxy boards) shown in Fig. 2 using a eutectic solder. Then apply a force in the direction shown in Fig. 3. The soldering should be done either with an iron or using the reflow method and should be conducted with care so that the soldering is uniform and free of defects such as heat shock.															
		 <table border="1" style="margin: 10px auto; border-collapse: collapse;"> <thead> <tr> <th>Type</th> <th>a</th> <th>b</th> <th>c</th> </tr> </thead> <tbody> <tr> <td>GJM03</td> <td>0.3</td> <td>0.9</td> <td>0.3</td> </tr> <tr> <td>GJM15</td> <td>0.4</td> <td>1.5</td> <td>0.5</td> </tr> </tbody> </table> <p style="text-align: center;">(in mm)</p>			Type	a	b	c	GJM03	0.3	0.9	0.3	GJM15	0.4	1.5	0.5			
Type	a	b	c																
GJM03	0.3	0.9	0.3																
GJM15	0.4	1.5	0.5																
		 <p style="text-align: center;">(in mm)</p>		Fig. 3															
13	Solderability of Termination	75% of the terminations are to be soldered evenly and continuously.		Immerse the capacitor in a solution of ethanol (JIS-K-8101) and rosin (JIS-K-5902) (25% rosin in weight proportion). Preheat at 80 to 120°C for 10 to 30 seconds. After preheating, immerse in eutectic solder solution for 2±0.5 seconds at 230±5°C or Sn-3.0Ag-0.5Cu solder solution for 2±0.5 seconds at 245±5°C.															
14	Resistance to Soldering Heat	The measured and observed characteristics should satisfy the specifications in the following table.		Preheat the capacitor at 120 to 150°C for 1 minute. Immerse the capacitor in a eutectic solder or Sn-3.0Ag-0.5Cu solder solution at 270±5°C for 10±0.5 seconds. Let sit at room temperature for 24±2 hours.															
		Appearance	No marking defects																
		Capacitance Change	Within ±2.5% or ±0.25pF (Whichever is larger)																
		Q	$Q \geq 400 + 20C$ C : Nominal Capacitance (pF)																
		I.R.	More than 10,000MΩ or 500Ω · F (Whichever is smaller)																
	Dielectric Strength	No failure																	
15	Temperature Cycle	The measured and observed characteristics should satisfy the specifications in the following table.		Fix the capacitor to the supporting jig in the same manner and under the same conditions as (10). Perform the five cycles according to the four heat treatments listed in the following table. Let sit for 24±2 hours at room temperature, then measure.															
		Appearance	No marking defects																
		Capacitance Change	Within ±2.5% or ±0.25pF (Whichever is larger)																
		Q	$Q \geq 400 + 20C$ C : Nominal Capacitance (pF)																
		I.R.	More than 10,000MΩ or 500Ω · F (Whichever is smaller)																
	Dielectric Strength	No failure																	
		<table border="1" style="margin: 0 auto; border-collapse: collapse;"> <thead> <tr> <th>Step</th> <th>1</th> <th>2</th> <th>3</th> <th>4</th> </tr> </thead> <tbody> <tr> <td>Temp. (°C)</td> <td>Min. Operating Temp. <math>+30</math></td> <td>Room Temp.</td> <td>Max. Operating Temp. <math>+30</math></td> <td>Room Temp.</td> </tr> <tr> <td>Time (min.)</td> <td>30±3</td> <td>2 to 3</td> <td>30±3</td> <td>2 to 3</td> </tr> </tbody> </table>		Step	1	2	3	4	Temp. (°C)	Min. Operating Temp. $+30$	Room Temp.	Max. Operating Temp. $+30$	Room Temp.	Time (min.)	30±3	2 to 3	30±3	2 to 3	
Step	1	2	3	4															
Temp. (°C)	Min. Operating Temp. $+30$	Room Temp.	Max. Operating Temp. $+30$	Room Temp.															
Time (min.)	30±3	2 to 3	30±3	2 to 3															
16	Humidity, Steady State	The measured and observed characteristics should satisfy the specifications in the following table.		Let the capacitor sit at 40±2°C and 90 to 95% humidity for 500±12 hours. Remove and let sit for 24±2 hours (temperature compensating type) at room temperature, then measure.															
		Appearance	No marking defects																
		Capacitance Change	Within ±5% or ±0.5pF (Whichever is larger)																
		Q	10pF and over, 30pF and below : $Q \geq 275 + \frac{C}{2}$ 10pF and below : $Q \geq 200 + 10C$ C : Nominal Capacitance (pF)																
	I.R.	More than 10,000MΩ or 500Ω · F (Whichever is smaller)																	

Continued on the following page. ↗

## Specifications and Test Methods

Continued from the preceding page.

No.	Item	Specifications		Test Method
		Temperature Compensating Type		
17	Humidity Load	The measured and observed characteristics should satisfy the specifications in the following table.		Apply the rated voltage at 40±2°C and 90 to 95% humidity for 500±12 hours. Remove and let sit for 24±2 hours at room temperature, then measure. The charge/discharge current is less than 50mA.
		Appearance	No marking defects	
		Capacitance Change	Within ±7.5% or ±0.75pF (Whichever is larger)	
		Q	30pF and below : $Q \geq 100 + \frac{10}{C}$ C : Nominal Capacitance (pF)	
		I.R.	More than 500MΩ or 25Ω · F (Whichever is smaller)	
	Dielectric Strength	No failure		
18	High Temperature Load	The measured and observed characteristics should satisfy the specifications in the following table.		Apply 200% of the rated voltage for 1000±12 hours at the maximum operating temperature ±3°C. Let sit for 24±2 hours (temperature compensating type) at room temperature, then measure. The charge/discharge current is less than 50mA.
		Appearance	No marking defects	
		Capacitance Change	Within ±3% or ±0.3pF (Whichever is larger)	
		Q	10pF and over, 30pF and below : $Q \geq 275 + \frac{5}{C}$ 10pF and below : $Q \geq 200 + 10C$ C : Nominal Capacitance (pF)	
		I.R.	More than 1,000MΩ or 50Ω · F (Whichever is smaller)	
	Dielectric Strength	No failure		
19	ESR	0.5pF ≤ C ≤ 1pF : 350mΩ below 1pF < C ≤ 5pF : 300mΩ below 5pF < C ≤ 10pF : 250mΩ below		The ESR should be measured at room Temperature. and frequency 1±0.2GHz with the equivalent of BOONTON Model 34A.
		10pF < C ≤ 20pF : 400mΩ below		The ESR should be measured at room Temperature. and frequency 500±50MHz with the equivalent of HP8753B.

Table A  
(1)

Char. Code	Temp. Coeff. (ppm/°C) *1	Capacitance Change from 25°C Value (%)					
		-55°C		-30°C		-10°C	
		Max.	Min.	Max.	Min.	Max.	Min.
5C	0±30	0.58	-0.24	0.40	-0.17	0.25	-0.11

\*1 : Nominal values denote the temperature coefficient within a range of 25 to 125°C.

(2)

Char.	Nominal Values (ppm/°C) *2	Capacitance Change from 20°C Value (%)					
		-55°C		-25°C		-10°C	
		Max.	Min.	Max.	Min.	Max.	Min.
2C	0±60	0.82	-0.45	0.49	-0.27	0.33	-0.18
3C	0±120	0.37	-0.90	0.82	-0.54	0.55	-0.36
4C	0±250	0.56	-0.88	1.54	-1.13	1.02	-0.75

\*2 : Nominal values denote the temperature coefficient within a range of 20 to 125°C.



# GRM Series Data

## ■ Capacitance-Temperature Characteristics

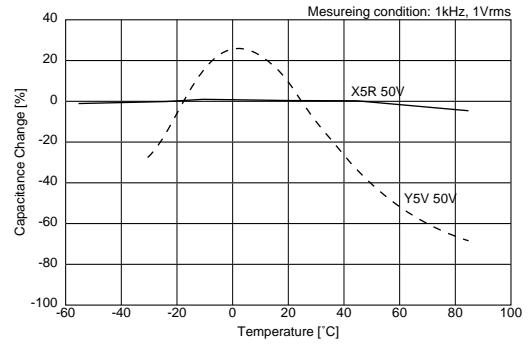
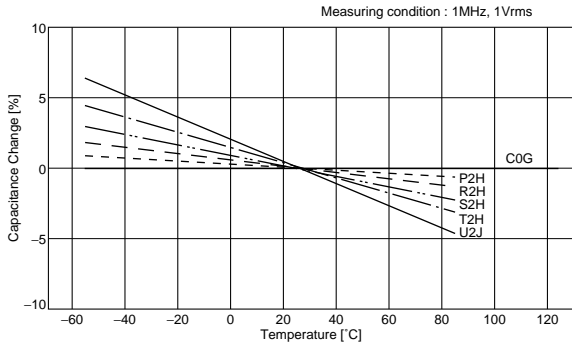

## ■ Capacitance-DC Voltage Characteristics

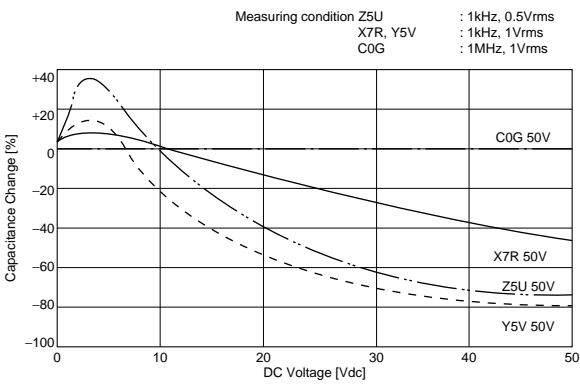

## ■ Capacitance-AC Voltage Characteristics

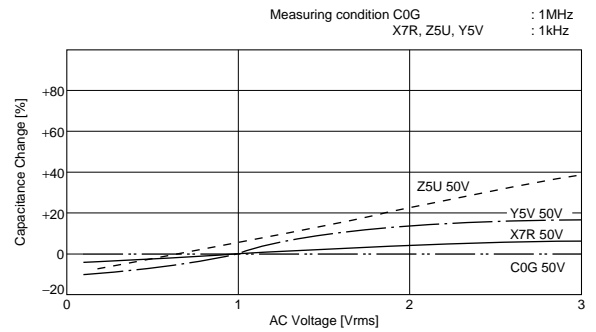

## ■ Capacitance Change-Aging

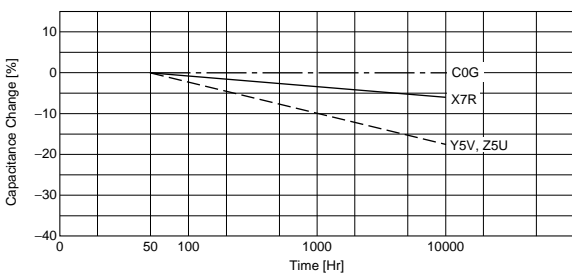

## ■ Impedance-Frequency Characteristics

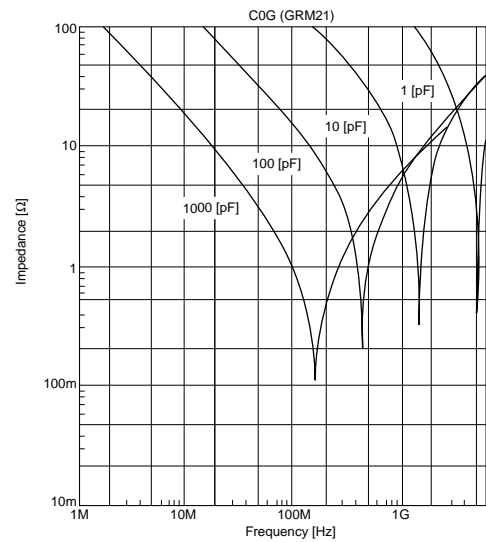

Continued on the following page. ↗

## GRM Series Data

Continued from the preceding page.

### Allowable Voltage-Frequency

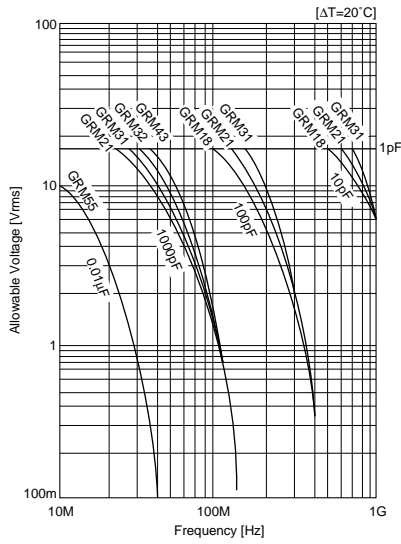

### Allowable Current-Frequency

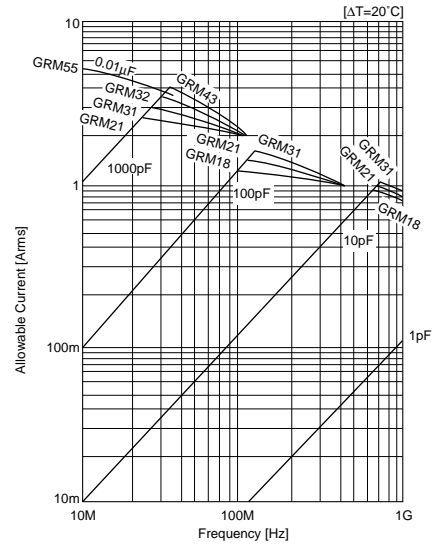

### Allowable Apparent Power

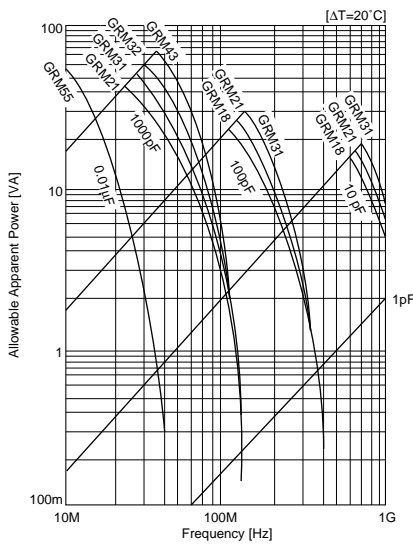

# Chip Monolithic Ceramic Capacitors



## Microchips GMA Series

### ■ Features

1. Better micro wave characteristics
2. Suitable for by-passing
3. High density mounting

### ■ Applications

1. Optical device for telecommunication
2. IC, IC packaging built-in
3. Measuring equipment

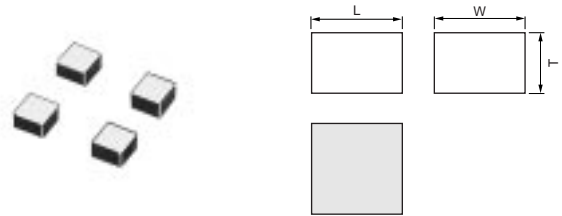

Part Number	Dimensions (mm)		
	L	W	T
<b>GMA05X</b>	0.5 ±0.05	0.5 ±0.05	0.35 ±0.05
<b>GMA085</b>	0.8 ±0.05	0.8 ±0.05	0.5 ±0.1

Part Number	TC Code (Standard)	Rated Voltage (Vdc)	Capacitance	Length L (mm)	Width W (mm)	Thickness T (mm)
<b>GMA05XR72A101MD01</b>	X7R (EIA)	100	100pF ±20%	0.5	0.5	0.35
<b>GMA05XR72A151MD01</b>	X7R (EIA)	100	150pF ±20%	0.5	0.5	0.35
<b>GMA05XR72A221MD01</b>	X7R (EIA)	100	220pF ±20%	0.5	0.5	0.35
<b>GMA085R72A331MD01</b>	X7R (EIA)	100	330pF ±20%	0.8	0.8	0.5
<b>GMA085R72A471MD01</b>	X7R (EIA)	100	470pF ±20%	0.8	0.8	0.5
<b>GMA085R72A681MD01</b>	X7R (EIA)	100	680pF ±20%	0.8	0.8	0.5
<b>GMA085R72A102MD01</b>	X7R (EIA)	100	1000pF ±20%	0.8	0.8	0.5
<b>GMA05XF52A102ZD01</b>	Y5V (EIA)	100	1000pF +80/-20%	0.5	0.5	0.35
<b>GMA085F52A103ZD01</b>	Y5V (EIA)	100	10000pF +80/-20%	0.8	0.8	0.5
<b>GMA05XR71H331MD01</b>	X7R (EIA)	50	330pF ±20%	0.5	0.5	0.35
<b>GMA05XR71H471MD01</b>	X7R (EIA)	50	470pF ±20%	0.5	0.5	0.35
<b>GMA05XR71C681MD01</b>	X7R (EIA)	16	680pF ±20%	0.5	0.5	0.35
<b>GMA05XR71C102MD01</b>	X7R (EIA)	16	1000pF ±20%	0.5	0.5	0.35
<b>GMA085R71C102MD01</b>	X7R (EIA)	16	1000pF ±20%	0.8	0.8	0.5
<b>GMA05XR71C152MD01</b>	X7R (EIA)	16	1500pF ±20%	0.5	0.5	0.35
<b>GMA085R71C152MD01</b>	X7R (EIA)	16	1500pF ±20%	0.8	0.8	0.5
<b>GMA05XR71C222MD01</b>	X7R (EIA)	16	2200pF ±20%	0.5	0.5	0.35
<b>GMA085R71C222MD01</b>	X7R (EIA)	16	2200pF ±20%	0.8	0.8	0.5
<b>GMA085R71C332MD01</b>	X7R (EIA)	16	3300pF ±20%	0.8	0.8	0.5
<b>GMA085R71C472MD01</b>	X7R (EIA)	16	4700pF ±20%	0.8	0.8	0.5
<b>GMA085R71C682MD01</b>	X7R (EIA)	16	6800pF ±20%	0.8	0.8	0.5
<b>GMA085R71C103MD01</b>	X7R (EIA)	16	10000pF ±20%	0.8	0.8	0.5
<b>GMA05XF51C472ZD01</b>	Y5V (EIA)	16	4700pF +80/-20%	0.5	0.5	0.35
<b>GMA05XF51C682ZD01</b>	Y5V (EIA)	16	6800pF +80/-20%	0.5	0.5	0.35
<b>GMA05XF51C103ZD01</b>	Y5V (EIA)	16	10000pF +80/-20%	0.5	0.5	0.35
<b>GMA085F51C473ZD01</b>	Y5V (EIA)	16	47000pF +80/-20%	0.8	0.8	0.5
<b>GMA05XF51A153ZD01</b>	Y5V (EIA)	10	15000pF +80/-20%	0.5	0.5	0.35
<b>GMA085F51A104ZD01</b>	Y5V (EIA)	10	0.1μF +80/-20%	0.8	0.8	0.5

## Specifications and Test Methods

No.	Item	Specifications	Test Method															
1	Operating Temperature Range	R7 : -55 to +125°C F5 : -30 to +85°C	Reference Temperature:25°C															
2	Rated Voltage	See the previous pages.	The rated voltage is defined as the maximum voltage which may be applied continuously to the capacitor. When AC voltage is superimposed on DC voltage, $V^{P-P}$ or $V^{O-P}$ , whichever is larger, should be maintained within the rated voltage range.															
3	Appearance	No defects or abnormality	Visual inspection															
4	Dimensions	See the previous pages.	Visual inspection															
5	Dielectric Strength	No defects or abnormality	No failure should be observed when a voltage of 250% of the rated voltage is applied between the both terminations for 1 to 5 seconds, provided the charge/discharge current is less than 50mA.															
6	Insulation Resistance	10,000MΩ min.	The insulation resistance should be measured with a DC voltage not exceeding the rated voltage at normal temperature and humidity and within 2 minutes of charging.															
7	Capacitance	Within the specified tolerance	The capacitance/D.F. should be measured at reference temperature at the frequency and voltage shown in the table.															
8	Dissipation Factor (D.F.)	R7 : 0.035 max. F5 : 0.09 max. (for 16V) : 0.125 max. (for 10V)	<table border="1"> <tr> <td>Frequency</td> <td>1±0.1kHz</td> </tr> <tr> <td>Voltage</td> <td>1±0.2Vrms</td> </tr> </table>	Frequency	1±0.1kHz	Voltage	1±0.2Vrms											
Frequency	1±0.1kHz																	
Voltage	1±0.2Vrms																	
9	Capacitance Temperature Characteristics	No bias R7 : Within +/-15% (-55 to +125°C) F5 : Within +22/-82% (-30 to +85°C)	<p>The capacitance change should be measured after 5min. at each specified temp. stage.</p> <ul style="list-style-type: none"> <li>The ranges of capacitance change compared with the Reference Temperature value over the temperature ranges shown in the table should be within the specified ranges.*</li> </ul> <p>In case of applying voltage, the capacitance change should be measured after 1 more min. with applying voltage in equilibration of each temp. stage.</p> <table border="1"> <thead> <tr> <th>Step</th> <th>Temperature (°C)</th> <th>Applying Voltage (V)</th> </tr> </thead> <tbody> <tr> <td>1</td> <td>Reference Temperature±2</td> <td rowspan="4">No bias</td> </tr> <tr> <td>2</td> <td>-55±3 (for R7) -30±3 (for F5)</td> </tr> <tr> <td>3</td> <td>Reference Temperature±2</td> </tr> <tr> <td>4</td> <td>125±3 (for R7) 85±3 (for F5)</td> </tr> </tbody> </table> <p>*Initial measurement for high dielectric constant type Perform a heat treatment at 150 +0/-10°C for one hour and then let sit for 48±4 hours at room temperature. Perform the initial measurement.</p>	Step	Temperature (°C)	Applying Voltage (V)	1	Reference Temperature±2	No bias	2	-55±3 (for R7) -30±3 (for F5)	3	Reference Temperature±2	4	125±3 (for R7) 85±3 (for F5)			
Step	Temperature (°C)	Applying Voltage (V)																
1	Reference Temperature±2	No bias																
2	-55±3 (for R7) -30±3 (for F5)																	
3	Reference Temperature±2																	
4	125±3 (for R7) 85±3 (for F5)																	
10	Mechanical Strength	Bond Strength Pull force : 3.0g min.	MIL-STD-883 Method 2011 Condition D Mount the capacitor on a gold metallized alumina substrate with Au-Sn (80/20) and bond a 20μm (0.0008 inch) gold wire to the capacitor terminal using an ultrasonic wedge bond. Then, pull wire.															
		Die Shear Strength Die Shear force : 200g min.	MIL-STD-883 Method 2019 Mount the capacitor on a gold metallized alumina substrate with Au-Sn (80/20). Apply the force parallel to the substrate.															
11	Vibration Resistance	Appearance No defects or abnormality	Ramp frequency from 10 to 55Hz then return to 10Hz all within 1 minute. Amplitude : 1.5 mm (0.06 inch) max. total excursion. Apply this motion for a period of 2 hours in each of 3 mutually perpendicular directions (total 6 hours).															
		Capacitance Within the specified tolerance																
		D.F. R7 : 0.035 max. F5 : 0.09 max. (for 16V) : 0.125 max. (for 10V)																
12	Temperature Cycle	Appearance No marked defect	The capacitor should be set for 48±4 hours at room temperature after one hour heat of treatment at 150+0/-10°C, then measure for the initial measurement. Fix the capacitor to the supporting jig in the same manner and under the same conditions as (11) and conduct the five cycles according to the temperatures and time shown in the following table. Set it for 48±4 hours at room temperature, then measure.															
		Capacitance Change R7 : Within ±7.5% F5 : Within ±20%																
		D.F. R7 : 0.035 max. F5 : 0.09 max. (for 16V) : 0.125 max. (for 10V)																
		I.R. 10,000MΩ min.																
		Dielectric Strength No failure																
			<table border="1"> <thead> <tr> <th>Step</th> <th>1</th> <th>2</th> <th>3</th> <th>4</th> </tr> </thead> <tbody> <tr> <td>Temp. (°C)</td> <td>Min. Operating Temp. +0/-3</td> <td>Room Temp.</td> <td>Max. Operating Temp. +3/-0</td> <td>Room Temp.</td> </tr> <tr> <td>Time (min.)</td> <td>30±3</td> <td>2 to 3</td> <td>30±3</td> <td>2 to 3</td> </tr> </tbody> </table>	Step	1	2	3	4	Temp. (°C)	Min. Operating Temp. +0/-3	Room Temp.	Max. Operating Temp. +3/-0	Room Temp.	Time (min.)	30±3	2 to 3	30±3	2 to 3
Step	1	2	3	4														
Temp. (°C)	Min. Operating Temp. +0/-3	Room Temp.	Max. Operating Temp. +3/-0	Room Temp.														
Time (min.)	30±3	2 to 3	30±3	2 to 3														

Continued on the following page. 

## Specifications and Test Methods

Continued from the preceding page.

No.	Item	Specifications	Test Method
13	Humidity (Steady State)	Appearance	No marked defect
		Capacitance Change	R7 : Within $\pm 12.5\%$ F5 : Within $\pm 30\%$
		D.F.	R7 : 0.05 max. F5 : 0.125 max. (for 16V) 0.15 max. (for 10V)
		I.R.	1,000M $\Omega$ min.
		Dielectric Strength	No failure
14	Humidity Load	Appearance	No marked defect
		Capacitance Change	R7 : Within $\pm 12.5\%$ F5 : Within $\pm 30/-40\%$
		D.F.	R7 : 0.05 max. F5 : 0.125 max. (for 16V) 0.15 max. (for 10V)
		I.R.	500M $\Omega$ min.
		Dielectric Strength	No failure
15	High Temperature Load	Appearance	No marked defect
		Capacitance Change	R7 : Within $\pm 12.5\%$ F5 : Within $+30/-40\%$
		D.F.	R7 : 0.05 max. F5 : 0.125 max. (for 16V) 0.15 max. (for 10V)
		I.R.	1,000M $\Omega$ min.
		Dielectric Strength	No failure
			<p>Set the capacitor for 500<math>\pm 12</math> hours at 40<math>\pm 20^\circ\text{C}</math>, in 90 to 95% humidity. Take it out and set it for 48<math>\pm 4</math> hours at room temperature, then measure.</p> <p>Apply the rated voltage for 500<math>\pm 12</math> hours at 40<math>\pm 2^\circ\text{C}</math>, in 90 to 95% humidity and set it for 48<math>\pm 4</math> hours at room temperature, then measure. The charge/discharge current is less than 50mA.</p> <ul style="list-style-type: none"> <li>Initial measurement for F1/F5</li> </ul> <p>Perform a heat treatment at 150+0/-10<math>^\circ\text{C}</math> for one hour and then let sit for 48<math>\pm 4</math> hours at room temperature. Perform the initial measurement.</p> <p>A voltage treatment should be given to the capacitor, in which a DC voltage of 200% the rated voltage is applied for one hour at the maximum operating temperature <math>\pm 3^\circ\text{C}</math> then it should be set for 48<math>\pm 4</math> hours at room temperature and the initial measurement should be conducted.</p> <p>Then apply the above mentioned voltage continuously for 1000<math>\pm 12</math> hours at the same temperature, remove it from the bath, and set it for 48<math>\pm 4</math> hours at room temperature, then measure. The charge/discharge current is less than 50mA.</p>

Mounting for testing : The capacitors should be mounted on the substrate as shown below using die bonding and wire bonding when tests No.11 to 15 are performed.

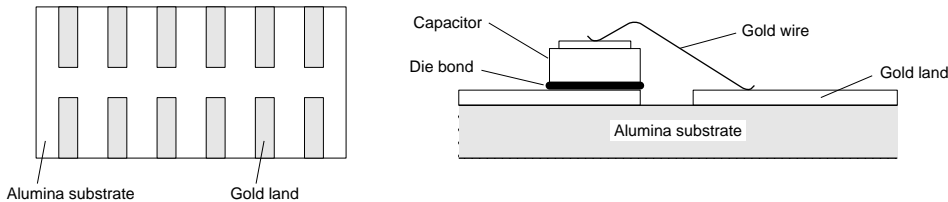

# Chip Monolithic Ceramic Capacitors



## Capacitor Arrays GNM Series

### ■ Features

1. High density mounting due to mounting space saving
2. Mounting cost saving

### ■ Applications

General electronic equipment

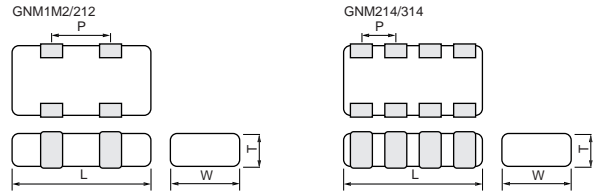

Part Number	Dimensions (mm)			
	L	W	T	P
<b>GNM1M2</b>	1.37 ±0.15	1.0 ±0.15	0.6 ±0.1 0.8 +0/-0.15	0.64 ±0.05
<b>GNM212</b> <b>GNM214</b>	2.0 ±0.15	1.25 ±0.15	0.85 ±0.1 0.6 ±0.1	1.0 ±0.1 0.5 ±0.05
<b>GNM314</b>	3.2 ±0.15	1.6 ±0.15	0.8 ±0.1 1.0 ±0.1	0.8 ±0.1

## Temperature Compensating Type

Part Number	GNM1M		GNM21	GNM31	
L x W	1.37x1.0		2.0x1.25	3.2x1.6	
TC	COG (5C)		COG (5C)	COG (5C)	
Rated Volt.	50 (1H)		50 (1H)	100 (2A)	50 (1H)
Capacitance, Capacitance Tolerance and T Dimension					
10pF(100)	K	0.6(2)	0.6(4)	0.8(4)	0.8(4)
15pF(150)	K	0.6(2)	0.6(4)	0.8(4)	0.8(4)
22pF(220)	K	0.6(2)	0.6(4)	0.8(4)	0.8(4)
27pF(270)	K	0.6(2)	0.6(4)	0.8(4)	0.8(4)
33pF(330)	K	0.6(2)	0.6(4)	0.8(4)	0.8(4)
39pF(390)	K	0.6(2)	0.6(4)	0.8(4)	0.8(4)
47pF(470)	K	0.6(2)	0.6(4)	0.8(4)	0.8(4)
68pF(680)	K	0.6(2)	0.6(4)	0.8(4)	0.8(4)
100pF(101)	K	0.6(2)	0.6(4)	0.8(4)	0.8(4)
150pF(151)	K	0.6(2)	0.6(4)	0.8(4)	0.8(4)
220pF(221)	K	0.6(2)	0.6(4)		0.8(4)
270pF(271)	K				0.8(4)
330pF(331)	K				0.8(4)

The part numbering code is shown in each ( ). The (4) code in T (mm) means number of elements (four).  
 Dimensions are shown in mm and Rated Voltage in Vdc.

## High Dielectric Constant Type GNM1M Series

Part Number	GNM1M					
L x W	1.37x1.00					
TC	X5R (R6)			X7R (R7)		
Rated Volt.	16 (1C)	10 (1A)	6.3 (0J)	50 (1H)	25 (1E)	16 (1C)
Capacitance, Capacitance Tolerance and T Dimension						
1000pF(102)	K, M			0.6(2)		
2200pF(222)	K, M				0.6(2)	
4700pF(472)	K, M				0.6(2)	
10000pF(103)	K, M				0.6(2)	
22000pF(223)	K, M					0.6(2)

Continued on the following page.



Continued from the preceding page.

Part Number	GNM1M					
L x W	1.37x1.00					
TC	X5R (R6)			X7R (R7)		
Rated Volt.	16 (1C)	10 (1A)	6.3 (0J)	50 (1H)	25 (1E)	16 (1C)
Capacitance, Capacitance Tolerance and T Dimension						
47000pF(473)	K, M					0.6(2)
0.10μF(104)	K, M		0.8(2)			
1.0μF(105)	K, M	0.8(2)	0.8(2)	0.8(2)		

The part numbering code is shown in each ( ). The (2) code in T (mm) means number of elements (two).  
 Dimensions are shown in mm and Rated Voltage in Vdc.  
 Please refer to Specification and Test Methods (2) about 1.0μF products.

## High Dielectric Constant Type GNM21 Series

Part Number	GNM21					
L x W	2.0x1.25					
TC	X5R (R6)			X7R (R7)		
Rated Volt.	16 (1C)	10 (1A)	50 (1H)	25 (1E)	16 (1C)	
Capacitance, Capacitance Tolerance and T Dimension						
1000pF(102)	K, M		0.6(4)			
2200pF(222)	K, M			0.6(4)		
4700pF(472)	K, M			0.6(4)		
10000pF(103)	K, M			0.6(4)		
22000pF(223)	K, M					0.85(4)
47000pF(473)	K, M					0.85(4)
0.10μF(104)	K, M					0.85(4)
0.47μF(474)	K, M	0.85(2)				
1.0μF(105)	K, M	0.85(2)	0.85(4)			
2.2μF(225)	K, M		0.85(2)			

The part numbering code is shown in each ( ). The (2) code in T (mm) means number of elements (two).  
 Dimensions are shown in mm and Rated Voltage in Vdc.  
 Please refer to Specification and Test Methods (2) about X5R, 10V products.

## High Dielectric Constant Type GNM31 Series

Part Number	GNM31			
L x W	3.2x1.6			
TC	X7R (R7)			X5R (R6)
Rated Volt.	100 (2A)	50 (1H)	16 (1C)	10 (1A)
Capacitance, Capacitance Tolerance and T Dimension				
220pF(221)	K, M	0.8(4)		
330pF(331)	K, M	0.8(4)		
470pF(471)	K, M	0.8(4)	0.8(4)	
680pF(681)	K, M	0.8(4)	0.8(4)	
1000pF(102)	K, M	0.8(4)	0.8(4)	
1500pF(152)	K, M	0.8(4)	0.8(4)	
2200pF(222)	K, M	0.8(4)	0.8(4)	
3300pF(332)	K, M	0.8(4)	0.8(4)	
4700pF(472)	K, M	0.8(4)	0.8(4)	
6800pF(682)	K, M		0.8(4)	
10000pF(103)	K, M		0.8(4)	

Continued on the following page. 

 Continued from the preceding page.

<b>Part Number</b>	<b>GNM31</b>			
<b>L x W</b>	3.2x1.6			
<b>TC</b>	X7R (R7)			X5R (R6)
<b>Rated Volt.</b>	100 (2A)	50 (1H)	16 (1C)	10 (1A)
<b>Capacitance, Capacitance Tolerance and T Dimension</b>				
15000pF(153)	K, M	0.8(4)		
22000pF(223)	K, M		0.8(4)	
33000pF(333)	K, M		0.8(4)	
47000pF(473)	K, M		1.0(4)	
68000pF(683)	K, M		1.0(4)	
0.10μF(104)	K, M		1.0(4)	
1.0μF(105)	K, M			0.85(4)

The part numbering code is shown in each ( ). The (4) code in T (mm) means number of elements (four).  
 Dimensions are shown in mm and Rated Voltage in Vdc.

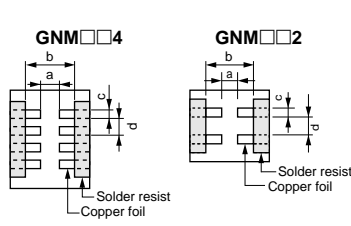

## GNM Series Specifications and Test Methods (1)

No.	Item	Specifications		Test Method																									
		Temperature Compensating Type	High Dielectric Type																										
1	Operating Temperature Range	5C : -55 to +125°C	R7 : -55 to +125°C R6 : -30 to +85°C																										
2	Rated Voltage	See the previous pages.		The rated voltage is defined as the maximum voltage which may be applied continuously to the capacitor. When AC voltage is superimposed on DC voltage, $V^{P-P}$ or $V^{O-P}$ , whichever is larger, should be maintained within the rated voltage range.																									
3	Appearance	No defects or abnormalities		Visual inspection																									
4	Dimensions	Within the specified dimensions		Using calipers																									
5	Dielectric Strength	No defects or abnormalities		No failure should be observed when 300% of the rated voltage (5C) or 250% of the rated voltage (R7) is applied between the terminations for 1 to 5 seconds, provided the charge/discharge current is less than 50mA.																									
6	Insulation Resistance	More than 10,000MΩ or 500Ω · F (Whichever is smaller)		The insulation resistance should be measured with a DC voltage not exceeding the rated voltage at 25°C and 75%RH max. and within 2 minutes of charging.																									
7	Capacitance	Within the specified tolerance		The capacitance/Q/D.F. should be measured at 25°C at the frequency and voltage shown in the table.																									
8	Q/ Dissipation Factor (D.F.)	30pF min. : $Q \geq 1000$ 30pF max. : $Q \geq 400+20C$  C : Nominal Capacitance (pF)	<table border="1" style="font-size: small;"> <tr> <th>Char.</th> <th>25V min.</th> <th>16V</th> <th>10V</th> <th>6.3V</th> </tr> <tr> <td>R7, R6</td> <td>0.025 max.</td> <td>0.035 max.</td> <td>0.035 max.</td> <td>0.05 max.</td> </tr> </table>	Char.	25V min.	16V	10V	6.3V	R7, R6	0.025 max.	0.035 max.	0.035 max.	0.05 max.	<table border="1" style="font-size: small;"> <tr> <th>Char.</th> <th>5C</th> <th>R7</th> </tr> <tr> <td>Item</td> <td></td> <td></td> </tr> <tr> <td>Frequency</td> <td>1±0.1MHz</td> <td>1±0.1kHz</td> </tr> <tr> <td>Voltage</td> <td>0.5 to 5Vrms</td> <td>1.0±0.2Vrms</td> </tr> </table>	Char.	5C	R7	Item			Frequency	1±0.1MHz	1±0.1kHz	Voltage	0.5 to 5Vrms	1.0±0.2Vrms			
			Char.	25V min.	16V	10V	6.3V																						
R7, R6	0.025 max.	0.035 max.	0.035 max.	0.05 max.																									
Char.	5C	R7																											
Item																													
Frequency	1±0.1MHz	1±0.1kHz																											
Voltage	0.5 to 5Vrms	1.0±0.2Vrms																											
9	Capacitance Temperature Characteristics	Capacitance Change	<table border="1" style="font-size: small;"> <tr> <th>Char.</th> <th>Temp. Range</th> <th>Reference Temp.</th> <th>Cap. Change</th> </tr> <tr> <td>R7</td> <td>-55°C to +125°C</td> <td rowspan="2">25°C</td> <td rowspan="2">Within ±15%</td> </tr> <tr> <td>R6</td> <td>-55°C to +85°C</td> </tr> </table>	Char.	Temp. Range	Reference Temp.	Cap. Change	R7	-55°C to +125°C	25°C	Within ±15%	R6	-55°C to +85°C	The capacitance change should be measured after 5 min. at each specified temperature stage. (1) Temperature Compensating Type The temperature coefficient is determined using the capacitance measured in step 3 as a reference. When cycling the temperature sequentially from step1 through 5, the capacitance should be within the specified tolerance for the temperature coefficient and capacitance change as Table A. The capacitance drift is calculated by dividing the differences between the maximum and minimum measured values in the steps 1, 3 and 5 by the cap. value in step 3.  <table border="1" style="font-size: small; margin: 10px auto;"> <thead> <tr> <th>Step</th> <th>Temperature (°C)</th> </tr> </thead> <tbody> <tr> <td>1</td> <td>25±2</td> </tr> <tr> <td>2</td> <td>-55±3 (for 5C/R7), -30±3 (for F5)</td> </tr> <tr> <td>3</td> <td>25±2</td> </tr> <tr> <td>4</td> <td>125±3 (for 5C/R7), 85±3 (for F5)</td> </tr> <tr> <td>5</td> <td>20±2</td> </tr> </tbody> </table> (2) High Dielectric Constant Type The ranges of capacitance change compared with the above 25°C value over the temperature ranges shown in the table should be within the specified ranges.	Step	Temperature (°C)	1	25±2	2	-55±3 (for 5C/R7), -30±3 (for F5)	3	25±2	4	125±3 (for 5C/R7), 85±3 (for F5)	5	20±2			
		Char.	Temp. Range	Reference Temp.	Cap. Change																								
		R7	-55°C to +125°C	25°C	Within ±15%																								
R6	-55°C to +85°C																												
Step	Temperature (°C)																												
1	25±2																												
2	-55±3 (for 5C/R7), -30±3 (for F5)																												
3	25±2																												
4	125±3 (for 5C/R7), 85±3 (for F5)																												
5	20±2																												
Temperature Coefficient	Within the specified tolerance (Table A)																												
Capacitance Drift	Within ±0.2% or ±0.05pF (Whichever is larger.)																												
10	Adhesive Strength of Termination	No removal of the terminations or other defect should occur.  <div style="text-align: center;">  </div>		Solder the capacitor to the test jig (glass epoxy board) shown in Fig.1 using a eutectic solder. Then apply 5N force in parallel with the test jig for 10±1 sec. The soldering should be done either with an iron or using the reflow method and should be conducted with care so that the soldering is uniform and free of defects such as heat shock.  <table border="1" style="font-size: small; margin: 10px auto;"> <thead> <tr> <th>Type</th> <th>a</th> <th>b</th> <th>c</th> <th>d</th> </tr> </thead> <tbody> <tr> <td>GNM1M2</td> <td>0.5</td> <td>1.6</td> <td>0.32</td> <td>0.32</td> </tr> <tr> <td>GNM212</td> <td>0.4</td> <td>1.8</td> <td>0.15</td> <td>0.5</td> </tr> <tr> <td>GNM214</td> <td>0.6</td> <td>2.0</td> <td>0.25</td> <td>0.25</td> </tr> <tr> <td>GNM314</td> <td>0.8</td> <td>2.5</td> <td>0.4</td> <td>0.4</td> </tr> </tbody> </table> (in mm)	Type	a	b	c	d	GNM1M2	0.5	1.6	0.32	0.32	GNM212	0.4	1.8	0.15	0.5	GNM214	0.6	2.0	0.25	0.25	GNM314	0.8	2.5	0.4	0.4
Type	a	b	c	d																									
GNM1M2	0.5	1.6	0.32	0.32																									
GNM212	0.4	1.8	0.15	0.5																									
GNM214	0.6	2.0	0.25	0.25																									
GNM314	0.8	2.5	0.4	0.4																									

10

Fig. 1

Continued on the following page.

## GNM Series Specifications and Test Methods (1)

Continued from the preceding page.

No.	Item	Specifications				Test Method																						
		Temperature Compensating Type	High Dielectric Type																									
11	Appearance	No defects or abnormalities				Solder the capacitor to the test jig (glass epoxy board) in the same manner and under the same conditions as (10). The capacitor should be subjected to a simple harmonic motion having a total amplitude of 1.5mm, the frequency being varied uniformly between the approximate limits of 10 and 55Hz. The frequency range, from 10 to 55Hz and return to 10Hz, should be traversed in approximately 1 minute. This motion should be applied for a period of 2 hours in each 3 mutually perpendicular directions (total of 6 hours).																						
	Capacitance	Within the specified tolerance																										
11	Vibration Resistance	Q/D.F.	30pF min. : $Q \geq 1000$ 30pF max. : $Q \geq 400+20C$  C : Nominal Capacitance (pF)	Char.	25V min.	16V	10V	6.3V																				
				R7, R6	0.025 max.	0.035 max.	0.035 max.	0.05 max.																				
12	Deflection	No cracking or marking defects should occur.				Solder the capacitor on the test jig (glass epoxy board) shown in Fig. 2 using a eutectic solder. Then apply a force in the direction shown in Fig. 3 for 5±1 sec. The soldering should be done either with an iron or using the reflow method and should be conducted with care so that the soldering is uniform and free of defects such as heat shock.																						
		<table border="1" style="margin: 10px auto; border-collapse: collapse;"> <thead> <tr> <th>Type</th> <th>a</th> <th>b</th> <th>c</th> <th>d</th> </tr> </thead> <tbody> <tr> <td>GNM1M2</td> <td>2.0±0.05</td> <td>0.5±0.05</td> <td>0.32±0.05</td> <td>0.32±0.05</td> </tr> <tr> <td>GNM212</td> <td>2.0±0.05</td> <td>0.6±0.05</td> <td>0.5±0.05</td> <td>0.5±0.05</td> </tr> <tr> <td>GNM214</td> <td>2.0±0.05</td> <td>0.7±0.05</td> <td>0.3±0.05</td> <td>0.2±0.05</td> </tr> <tr> <td>GNM314</td> <td>2.5±0.05</td> <td>0.8±0.05</td> <td>0.4±0.05</td> <td>0.4±0.05</td> </tr> </tbody> </table> <p style="text-align: center;">(in mm)</p>					Type	a	b	c	d	GNM1M2	2.0±0.05	0.5±0.05	0.32±0.05	0.32±0.05	GNM212	2.0±0.05	0.6±0.05	0.5±0.05	0.5±0.05	GNM214	2.0±0.05	0.7±0.05	0.3±0.05	0.2±0.05	GNM314	2.5±0.05
Type	a	b	c	d																								
GNM1M2	2.0±0.05	0.5±0.05	0.32±0.05	0.32±0.05																								
GNM212	2.0±0.05	0.6±0.05	0.5±0.05	0.5±0.05																								
GNM214	2.0±0.05	0.7±0.05	0.3±0.05	0.2±0.05																								
GNM314	2.5±0.05	0.8±0.05	0.4±0.05	0.4±0.05																								
		<p style="text-align: center;">Fig. 3</p>																										
13	Solderability of Termination	75% of the terminations are to be soldered evenly and continuously.				Immerse the capacitor in a solution of ethanol (JIS-K-8101) and rosin (JIS-K-5902) (25% rosin in weight proportion). Preheat at 80 to 120°C for 10 to 30 seconds. After preheating, immerse in eutectic solder solution for 2±0.5 seconds at 230±5°C or Sn-3.0Ag-0.5Cu solder solution for 2±0.5 seconds at 245±5°C.																						
14	Resistance to Soldering Heat	The measured and observed characteristics should satisfy the specifications in the following table.				Preheat the capacitor at 120 to 150°C for 1 minute. Immerse the capacitor in a eutectic solder or Sn-3.0Ag-0.5Cu solder solution at 270±5°C for 10±0.5 seconds. Let sit at room temperature for 24±2 hours, then measure.  • Initial measurement for high dielectric constant type Perform a heat treatment at 150+0/-10°C for one hour and then let sit for 24±2 hours at room temperature. Perform the initial measurement.																						
	Appearance	No marking defects																										
	Capacitance Change	Within ±2.5% or ±0.25pF (Whichever is larger)	R7, R6 : Within ±7.5%																									
	Q/D.F.	30pF min. : $Q \geq 1000$ 30pF max. : $Q \geq 400+20C$  C : Nominal Capacitance (pF)	Char.	25V min.	16V		10V	6.3V																				
			R7, R6	0.025 max.	0.035 max.		0.035 max.	0.05 max.																				
	I.R.	More than 10,000MΩ or 500Ω · F (Whichever is smaller)																										
	Dielectric Strength	No failure																										

Continued on the following page.

## GNM Series Specifications and Test Methods (1)

Continued from the preceding page.

No.	Item	Specifications				Test Method															
		Temperature Compensating Type	High Dielectric Type																		
15	Temperature Cycle	The measured and observed characteristics should satisfy the specifications in the following table.				Fix the capacitor to the supporting jig in the same manner and under the same conditions as (10). Perform the five cycles according to the four heat treatments listed in the following table. Let sit for 24±2 hours (temperature compensating type) or 48±4 hours (high dielectric constant type) at room temperature, then measure. <table border="1" style="margin: 10px auto; border-collapse: collapse;"> <thead> <tr> <th>Step</th> <th>1</th> <th>2</th> <th>3</th> <th>4</th> </tr> </thead> <tbody> <tr> <td>Temp. (°C)</td> <td>Min. Operating Temp. +0/-3</td> <td>Room Temp.</td> <td>Max. Operating Temp. +3/-0</td> <td>Room Temp.</td> </tr> <tr> <td>Time (min.)</td> <td>30±3</td> <td>2 to 3</td> <td>30±3</td> <td>2 to 3</td> </tr> </tbody> </table> <ul style="list-style-type: none"> <li>• Initial measurement for high dielectric constant type</li> <li>Perform a heat treatment at 150+0/-10°C for one hour and then let sit for 24±2 hours at room temperature.</li> <li>Perform the initial measurement.</li> </ul>	Step	1	2	3	4	Temp. (°C)	Min. Operating Temp. +0/-3	Room Temp.	Max. Operating Temp. +3/-0	Room Temp.	Time (min.)	30±3	2 to 3	30±3	2 to 3
	Step	1	2	3	4																
	Temp. (°C)	Min. Operating Temp. +0/-3	Room Temp.	Max. Operating Temp. +3/-0	Room Temp.																
	Time (min.)	30±3	2 to 3	30±3	2 to 3																
	Appearance	No marking defects																			
	Capacitance Change	Within ±2.5% or ±0.25pF (Whichever is larger)	R7, R6 : Within ±7.5%																		
Q/D.F.	30pF min. : Q≥1000 30pF max. : Q≥400+20C	<table border="1" style="border-collapse: collapse; text-align: center;"> <thead> <tr> <th>Char.</th> <th>25V min.</th> <th>16V</th> <th>10V</th> <th>6.3V</th> </tr> </thead> <tbody> <tr> <td>R7, R6</td> <td>0.025 max.</td> <td>0.035 max.</td> <td>0.035 max.</td> <td>0.05 max.</td> </tr> </tbody> </table>			Char.	25V min.	16V	10V	6.3V	R7, R6	0.025 max.	0.035 max.	0.035 max.	0.05 max.							
	Char.	25V min.	16V	10V	6.3V																
R7, R6	0.025 max.	0.035 max.	0.035 max.	0.05 max.																	
C:Nominal Capacitance (pF)																					
I.R.	More than 10,000MΩ or 500Ω · F (Whichever is smaller)																				
Dielectric Strength	No failure																				
16	Humidity Steady State	The measured and observed characteristics should satisfy the specifications in the following table.				Sit the capacitor at 40±2°C and 90 to 95% humidity for 500±12 hours. Remove and let sit for 24±2 hours at room temperature, then measure.															
	Appearance	No marking defects																			
	Capacitance Change	Within ±5% or ±0.5pF (Whichever is larger)	R7, R6 : Within ±12.5%																		
	Q/D.F.	30pF and over : Q≥350 10pF and over, 30pF and below: Q≥275+5C/2 10pF and below : Q≥200+10C	<table border="1" style="border-collapse: collapse; text-align: center;"> <thead> <tr> <th>Char.</th> <th>25V min.</th> <th>16V</th> <th>10V/6.3V</th> </tr> </thead> <tbody> <tr> <td>R7, R6</td> <td>0.05 max.</td> <td>0.05 max.</td> <td>0.05 max.</td> </tr> </tbody> </table>				Char.	25V min.	16V	10V/6.3V	R7, R6	0.05 max.	0.05 max.	0.05 max.							
		Char.	25V min.	16V	10V/6.3V																
	R7, R6	0.05 max.	0.05 max.	0.05 max.																	
C : Nominal Capacitance (pF)																					
I.R.	More than 1,000MΩ or 50Ω · F (Whichever is smaller)																				
Dielectric Strength	No failure																				
17	Humidity Load	The measured and observed characteristics should satisfy the specifications in the following table.				Apply the rated voltage at 40±2°C and 90 to 95% humidity for 500±12 hours. Remove and let sit for 24±2 hours at room temperature, then measure. The charge/discharge current is less than 50mA.															
	Appearance	No marking defects																			
	Capacitance Change	Within ±7.5% or ±0.75pF (Whichever is larger)	R7, R6 : Within ±12.5%																		
	Q/D.F.	30pF and over : Q≥200 30pF and below : Q≥100+10C/3	<table border="1" style="border-collapse: collapse; text-align: center;"> <thead> <tr> <th>Char.</th> <th>25V min.</th> <th>16V</th> <th>10V/6.3V</th> </tr> </thead> <tbody> <tr> <td>R7, R6</td> <td>0.05 max.</td> <td>0.05 max.</td> <td>0.05 max.</td> </tr> </tbody> </table>				Char.	25V min.	16V	10V/6.3V	R7, R6	0.05 max.	0.05 max.	0.05 max.							
		Char.	25V min.	16V	10V/6.3V																
	R7, R6	0.05 max.	0.05 max.	0.05 max.																	
C : Nominal Capacitance (pF)																					
I.R.	More than 500MΩ or 25Ω · F (Whichever is smaller)																				
Dielectric Strength	No failure																				

Continued on the following page.

## GNM Series Specifications and Test Methods (1)

Continued from the preceding page.

No.	Item	Specifications				Test Method						
		Temperature Compensating Type	High Dielectric Type									
18	High Temperature Load	The measured and observed characteristics should satisfy the specifications in the following table.				Apply 200% of the rated voltage for 1000±12 hours at the maximum operating temperature ±3°C. Let sit for 24±2 hours at room temperature, then measure. The charge/discharge current is less than 50mA.  • Initial measurement for high dielectric constant type. Apply 200% of the rated DC voltage for one hour at the maximum operating temperature ±3°C. Remove and let sit for 24±2 hours at room temperature. Perform initial measurement.						
	Appearance	No marking defects										
	Capacitance Change	Within ±3% or ±0.3pF (Whichever is larger)	R7, R6 : Within ±12.5%									
	Q/D.F.	30pF and over : Q≥350 10pF and over, 30pF and below : Q≥275+5C/2 10pF and below : Q≥200+10C C : Nominal Capacitance (pF)	<table border="1" style="font-size: small; border-collapse: collapse;"> <thead> <tr> <th style="width: 5%;">Char.</th> <th style="width: 10%;">25V min.</th> <th style="width: 10%;">16V</th> <th style="width: 10%;">10V/6.3V</th> </tr> </thead> <tbody> <tr> <td style="text-align: center;">R7, R6</td> <td style="text-align: center;">0.04 max.</td> <td style="text-align: center;">0.05 max.</td> <td style="text-align: center;">0.05 max.</td> </tr> </tbody> </table>	Char.	25V min.		16V	10V/6.3V	R7, R6	0.04 max.	0.05 max.	0.05 max.
Char.	25V min.	16V	10V/6.3V									
R7, R6	0.04 max.	0.05 max.	0.05 max.									
I.R.	More than 1,000MΩ or 50Ω · F (Whichever is smaller)											

**Table A**

Char.	Nominal Values (ppm/°C) Note 1	Capacitance Change from 25°C (%)					
		-55°C		-30°C		-10°C	
		Max.	Min.	Max.	Min.	Max.	Min.
5C	0±30	0.58	-0.24	0.40	-0.17	0.25	-0.11

Note 1 : Nominal values denote the temperature coefficient within a range of 25 to 125°C.

10

## GNM Series Specifications and Test Methods (2)

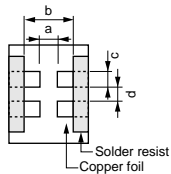
No.	Item	Specifications	Test Method																				
1	Operating Temperature Range	R6 : -55°C to +85°C																					
2	Rated Voltage	See the previous pages.	The rated voltage is defined as the maximum voltage which may be applied continuously to the capacitor. When AC voltage is superimposed on DC voltage, $V^{P-P}$ or $V^{O-P}$ , whichever is larger, should be maintained within the rated voltage range.																				
3	Appearance	No defects or abnormalities	Visual inspection																				
4	Dimensions	Within the specified dimension	Using calipers																				
5	Dielectric Strength	No defects or abnormalities	No failure should be observed when 250% of the rated voltage is applied between the terminations for 1 to 5 seconds, provided the charge/discharge current is less than 50mA.																				
6	Insulation Resistance	50Ω · F min.	The insulation resistance should be measured with a DC voltage not exceeding the rated voltage at 25°C and 75%RH max. and within 1 minutes of charging.																				
7	Capacitance	Within the specified tolerance	The capacitance/D.F. should be measured at 25°C at the frequency and voltage shown in the table.																				
8	Dissipation Factor (D.F.)	0.1 max.	<table border="1" style="margin-left: auto; margin-right: auto;"> <thead> <tr> <th>Capacitance</th> <th>Frequency</th> <th>Voltage</th> </tr> </thead> <tbody> <tr> <td>R6</td> <td>1±0.1kHz</td> <td>0.5±0.1Vrms</td> </tr> </tbody> </table>	Capacitance	Frequency	Voltage	R6	1±0.1kHz	0.5±0.1Vrms														
Capacitance	Frequency	Voltage																					
R6	1±0.1kHz	0.5±0.1Vrms																					
9	Capacitance Temperature Characteristics	<table border="1" style="margin-left: auto; margin-right: auto;"> <thead> <tr> <th>Char.</th> <th>Temp. Range</th> <th>Reference Temp.</th> <th>Cap. Change</th> </tr> </thead> <tbody> <tr> <td>R6</td> <td>-55 to +85°C</td> <td>25°C</td> <td>Within ±15%</td> </tr> </tbody> </table>	Char.	Temp. Range	Reference Temp.	Cap. Change	R6	-55 to +85°C	25°C	Within ±15%	<p>The capacitance change should be measured after 5 min. at each specified temperature stage.</p> <table border="1" style="margin-left: auto; margin-right: auto;"> <thead> <tr> <th>Step</th> <th>Temperature (°C)</th> </tr> </thead> <tbody> <tr> <td>1</td> <td>25±2</td> </tr> <tr> <td>2</td> <td>-55±3</td> </tr> <tr> <td>3</td> <td>25±2</td> </tr> <tr> <td>4</td> <td>85±3</td> </tr> <tr> <td>5</td> <td>25±2</td> </tr> </tbody> </table> <p>The ranges of capacitance change compared with the 25°C value over the temperature ranges shown in the table should be within the specified ranges.</p> <ul style="list-style-type: none"> <li>Initial measurement for high dielectric constant type.</li> <li>Perform a heat treatment at 150+0/-10°C for one hour and then set for 24±2 hours at room temperature.</li> <li>Perform the initial measurement.</li> </ul>	Step	Temperature (°C)	1	25±2	2	-55±3	3	25±2	4	85±3	5	25±2
Char.	Temp. Range	Reference Temp.	Cap. Change																				
R6	-55 to +85°C	25°C	Within ±15%																				
Step	Temperature (°C)																						
1	25±2																						
2	-55±3																						
3	25±2																						
4	85±3																						
5	25±2																						
10	Adhesive Strength of Termination	<p>No removal of the terminations or other defects should occur.</p> <div style="text-align: center;">  <p>Fig. 1</p> </div>	<p>Solder the capacitor to the test jig (glass epoxy board) shown in Fig. 1 using a eutectic solder.</p> <p>Then apply 5N force in parallel with the test jig for 10±1 sec. The soldering should be done either with an iron or using the reflow method and should be conducted with care so that the soldering is uniform and free of defects such as heat shock.</p> <table border="1" style="margin-left: auto; margin-right: auto;"> <thead> <tr> <th>Type</th> <th>a</th> <th>b</th> <th>c</th> <th>d</th> </tr> </thead> <tbody> <tr> <td>GNM1M2</td> <td>0.5</td> <td>1.6</td> <td>0.32</td> <td>0.32</td> </tr> <tr> <td>GNM212</td> <td>0.4</td> <td>1.8</td> <td>0.15</td> <td>0.5</td> </tr> </tbody> </table> <p style="text-align: right;">(in mm)</p>	Type	a	b	c	d	GNM1M2	0.5	1.6	0.32	0.32	GNM212	0.4	1.8	0.15	0.5					
Type	a	b	c	d																			
GNM1M2	0.5	1.6	0.32	0.32																			
GNM212	0.4	1.8	0.15	0.5																			
11	Vibration	Appearance	No defects or abnormalities																				
		Capacitance	Within the specified tolerance																				
		D.F.	0.1 max.																				
			<p>Solder the capacitor to the test jig (glass epoxy board) in the same manner and under the same conditions as (10).</p> <p>The capacitor should be subjected to a simple harmonic motion having a total amplitude of 1.5mm, the frequency being varied uniformly between the approximate limits of 10 and 55Hz. The frequency range, from 10 to 55Hz and return to 10Hz, should be traversed in approximately 1 minute. This motion should be applied for a period of 2 hours in each 3 mutually perpendicular directions (total of 6 hours).</p>																				

Continued on the following page.

## GNM Series Specifications and Test Methods (2)

Continued from the preceding page.

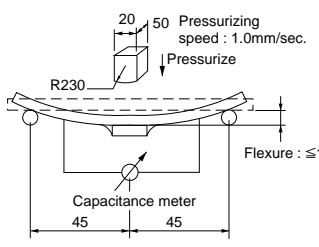
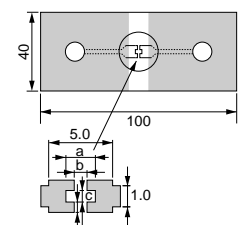
No.	Item	Specifications	Test Method																									
12	Deflection	No cracking or marking defects shall occur.   <p style="text-align: center;">Fig. 3</p>	Solder the capacitor to the test jig (glass epoxy board) shown in Fig. 2 using a eutectic solder. Then apply a force in the direction shown in Fig. 3. The soldering should be done either with an iron or using the reflow method and should be conducted with care so that the soldering is uniform and free of defects such as heat shock.   <p style="text-align: right;">Thickness : 0.8mm</p> <table border="1" style="margin-left: auto; margin-right: auto;"> <thead> <tr> <th>Type</th> <th>a</th> <th>b</th> <th>c</th> <th>d</th> </tr> </thead> <tbody> <tr> <td>GNM1M2</td> <td>2.0±0.5</td> <td>0.5±0.05</td> <td>0.32±0.05</td> <td>0.32±0.05</td> </tr> <tr> <td>GNM212</td> <td>2.0±0.05</td> <td>0.6±0.05</td> <td>0.5±0.05</td> <td>0.5±0.05</td> </tr> </tbody> </table> <p style="text-align: right;">(in mm)</p> <p style="text-align: center;">Fig. 2</p>	Type	a	b	c	d	GNM1M2	2.0±0.5	0.5±0.05	0.32±0.05	0.32±0.05	GNM212	2.0±0.05	0.6±0.05	0.5±0.05	0.5±0.05										
Type	a	b	c	d																								
GNM1M2	2.0±0.5	0.5±0.05	0.32±0.05	0.32±0.05																								
GNM212	2.0±0.05	0.6±0.05	0.5±0.05	0.5±0.05																								
13	Solderability of Termination	75% of the terminations are to be soldered evenly and continuously.	Immerse the capacitor in a solution of ethanol (JIS-K-8101) and rosin (JIS-K-5902) (25% rosin in weight proportion). Preheat at 80 to 120°C for 10 to 30 seconds. After preheating, immerse in eutectic solder solution for 2±0.5 seconds at 230±5°C or Sn-3.0Ag-0.5Cu solder solution for 2±0.5 seconds at 245±5°C.																									
14	Resistance to Soldering Heat	<table border="1" style="width: 100%; border-collapse: collapse;"> <tr> <td style="width: 15%;">Appearance</td> <td>No marking defects</td> </tr> <tr> <td>Capacitance Change</td> <td>R6: Within ±7.5%</td> </tr> <tr> <td>D.F.</td> <td>0.1 max.</td> </tr> <tr> <td>I.R.</td> <td>50Ω · F min.</td> </tr> <tr> <td>Dielectric Strength</td> <td>No failure</td> </tr> </table>	Appearance	No marking defects	Capacitance Change	R6: Within ±7.5%	D.F.	0.1 max.	I.R.	50Ω · F min.	Dielectric Strength	No failure	Preheat the capacitor at 120 to 150°C for 1 minute. Immerse the capacitor in a eutectic solder or Sn-3.0Ag-0.5Cu solder solution at 270±5°C for 10±0.5 seconds. Let sit at room temperature for 24±2 hours, then measure. • Initial measurement Perform a heat treatment at 150 +0/-10°C for one hour and then let sit for 24±2 hours at room temperature. Perform the initial measurement.															
Appearance	No marking defects																											
Capacitance Change	R6: Within ±7.5%																											
D.F.	0.1 max.																											
I.R.	50Ω · F min.																											
Dielectric Strength	No failure																											
15	Temperature Cycle	<table border="1" style="width: 100%; border-collapse: collapse;"> <tr> <td style="width: 15%;">Appearance</td> <td>No marking defects</td> </tr> <tr> <td>Capacitance Change</td> <td>R6: Within ±12.5%</td> </tr> <tr> <td>D.F.</td> <td>0.1 max.</td> </tr> <tr> <td>I.R.</td> <td>50Ω · F min.</td> </tr> <tr> <td>Dielectric Strength</td> <td>No failure</td> </tr> </table>	Appearance	No marking defects	Capacitance Change	R6: Within ±12.5%	D.F.	0.1 max.	I.R.	50Ω · F min.	Dielectric Strength	No failure	Fix the capacitor to the supporting jig in the same manner and under the same conditions as (10). Perform the five cycles according to the four heat treatments listed in the following table. Let sit for 24±2 hours at room temperature, then measure.  <table border="1" style="margin-left: auto; margin-right: auto;"> <thead> <tr> <th>Step</th> <th>1</th> <th>2</th> <th>3</th> <th>4</th> </tr> </thead> <tbody> <tr> <td>Temp. (°C)</td> <td>Min. Operating Temp.</td> <td>Room Temp.</td> <td>Max. Operating Temp.</td> <td>Room Temp.</td> </tr> <tr> <td>Time (min.)</td> <td>30±3</td> <td>2 to 3</td> <td>30±3</td> <td>2 to 3</td> </tr> </tbody> </table> • Initial measurement Perform a heat treatment at 150 +0/-10 °C for one hour and then let sit for 24±2 hours at room temperature. Perform the initial measurement.	Step	1	2	3	4	Temp. (°C)	Min. Operating Temp.	Room Temp.	Max. Operating Temp.	Room Temp.	Time (min.)	30±3	2 to 3	30±3	2 to 3
Appearance	No marking defects																											
Capacitance Change	R6: Within ±12.5%																											
D.F.	0.1 max.																											
I.R.	50Ω · F min.																											
Dielectric Strength	No failure																											
Step	1	2	3	4																								
Temp. (°C)	Min. Operating Temp.	Room Temp.	Max. Operating Temp.	Room Temp.																								
Time (min.)	30±3	2 to 3	30±3	2 to 3																								
16	High Temperature High Humidity (Steady)	<table border="1" style="width: 100%; border-collapse: collapse;"> <tr> <td style="width: 15%;">Appearance</td> <td>No marking defects</td> </tr> <tr> <td>Capacitance Change</td> <td>R6: Within ±12.5%</td> </tr> <tr> <td>D.F.</td> <td>0.2 max.</td> </tr> <tr> <td>I.R.</td> <td>12.5Ω · F min.</td> </tr> <tr> <td>Dielectric Strength</td> <td>No failure</td> </tr> </table>	Appearance	No marking defects	Capacitance Change	R6: Within ±12.5%	D.F.	0.2 max.	I.R.	12.5Ω · F min.	Dielectric Strength	No failure	Apply the rated voltage at 40±2°C and 90 to 95% humidity for 500±12 hours. The charge/discharge current is less than 50mA. • Initial measurement Perform a heat treatment at 150 +0/-10°C for one hour and then let sit for 24±2 hours at room temperature. Perform the initial measurement. • Measurement after test Perform a heat treatment at 150 +0/-10°C for one hour and then let sit for 24±2 hours at room temperature, then measure.															
Appearance	No marking defects																											
Capacitance Change	R6: Within ±12.5%																											
D.F.	0.2 max.																											
I.R.	12.5Ω · F min.																											
Dielectric Strength	No failure																											
17	Durability	<table border="1" style="width: 100%; border-collapse: collapse;"> <tr> <td style="width: 15%;">Appearance</td> <td>No marking defects</td> </tr> <tr> <td>Capacitance Change</td> <td>R6: Within ±12.5%</td> </tr> <tr> <td>D.F.</td> <td>0.2 max.</td> </tr> <tr> <td>I.R.</td> <td>25Ω · F min.</td> </tr> <tr> <td>Dielectric Strength</td> <td>No failure</td> </tr> </table>	Appearance	No marking defects	Capacitance Change	R6: Within ±12.5%	D.F.	0.2 max.	I.R.	25Ω · F min.	Dielectric Strength	No failure	Apply 125% of the rated voltage for 1000±12 hours at the maximum operating temperature ±3°C. Let sit for 24±2 hours at room temperature, then measure. The charge/discharge current is less than 50mA. • Initial measurement Perform a heat treatment at 150 +0/-10°C for one hour and then let sit for 24±2 hours at room temperature. Perform the initial measurement. • Measurement after test Perform a heat treatment at 150 +0/-10°C for one hour and then let sit for 24±2 hours at room temperature, then measure.															
Appearance	No marking defects																											
Capacitance Change	R6: Within ±12.5%																											
D.F.	0.2 max.																											
I.R.	25Ω · F min.																											
Dielectric Strength	No failure																											

# Chip Monolithic Ceramic Capacitors



## for Ultrasonic Sensors GRM Series

### ■ Features

1. Proper to compensate for ultrasonic sensor
2. Small chip size and high cap. value

### ■ Applications

Ultrasonic sensor  
 (Back sonar, Corner sonar and etc.)

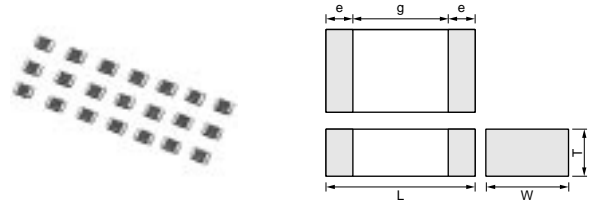

Part Number	Dimensions (mm)				
	L	W	T	e	g min.
<b>GRM219</b>	2.0 ±0.1	1.25 ±0.1	0.85 ±0.1	0.2 to 0.7	0.7

Part Number	TC Code	Rated Voltage (Vdc)	Capacitance (pF)	Length L (mm)	Width W (mm)	Thickness T (mm)
<b>GRM2199E2A102KD42</b>	ZLM (Murata)	100	1000 ±10%	2.0	1.25	0.85
<b>GRM2199E2A152KD42</b>	ZLM (Murata)	100	1500 ±10%	2.0	1.25	0.85

## Specifications and Test Methods

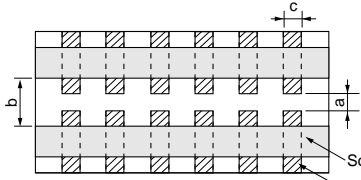
No.	Item	Specifications	Test Method												
1	Operating Temperature	-25 to +85°C	Reference Temperature: 20°C												
2	Rated Voltage	See the previous pages.	The rated voltage is defined as the maximum voltage which may be applied continuously to the capacitor. When AC voltage is superimposed on DC voltage, $V^{P-P}$ or $V^{O-P}$ , whichever is larger, should be maintained within the rated voltage range.												
3	Appearance	No defects or abnormalities	Visual inspection												
4	Dimensions	Within the specified dimensions	Using calipers												
5	Dielectric Strength	No defects or abnormalities	No failure should be observed when 300% of the rated voltage is applied between the terminations for 1 to 5 seconds, provided the charge/discharge current is less than 50mA.												
6	Insulation Resistance (I.R.)	More than 10,000MΩ	The insulation resistance should be measured with a DC voltage not exceeding the rated voltage at 20°C and 75%RH max. and within 2 minutes of charging.												
7	Capacitance	Within the specified tolerance	The capacitance/D.F. should be measured at 20°C with 1±0.1kHz in frequency and 1±0.2Vrms in voltage.												
8	Dissipation Factor (D.F.)	0.01 max.													
9	Capacitance Temperature Characteristics	Within $-4,700 \pm 1,999$ ppm/°C (at -25 to +20°C) Within $-4,700 \pm 999$ ppm/°C (at +20 to +85°C)	<p>The temperature coefficient is determined using the capacitance measured in step 1 as a reference. When cycling the temperature sequentially from step 1 through 5, the capacitance should be within the specified tolerance for the temperature coefficient. The capacitance change should be measured after 5 min. at each specified temperature stage.</p> <table border="1"> <thead> <tr> <th>Step</th> <th>Temperature (°C)</th> </tr> </thead> <tbody> <tr> <td>1</td> <td>20±2</td> </tr> <tr> <td>2</td> <td>-25±3</td> </tr> <tr> <td>3</td> <td>20±2</td> </tr> <tr> <td>4</td> <td>85±3</td> </tr> <tr> <td>5</td> <td>20±2</td> </tr> </tbody> </table>	Step	Temperature (°C)	1	20±2	2	-25±3	3	20±2	4	85±3	5	20±2
Step	Temperature (°C)														
1	20±2														
2	-25±3														
3	20±2														
4	85±3														
5	20±2														
10	Adhesive Strength of Termination	No removal of the terminations or other defect should occur.	<p>Solder the capacitor to the test jig (glass epoxy board) shown in Fig.1 using a eutectic solder. Then apply 10N force in the direction of the arrow. The soldering should be done either with an iron or using the reflow method and should be conducted with care so that the soldering is uniform and free of defects such as heat shock.</p>  <table border="1"> <thead> <tr> <th>Type</th> <th>a</th> <th>b</th> <th>c</th> </tr> </thead> <tbody> <tr> <td>GRM21</td> <td>1.2</td> <td>4.0</td> <td>1.65</td> </tr> </tbody> </table> <p>(in mm)</p> <p>Fig. 1</p>	Type	a	b	c	GRM21	1.2	4.0	1.65				
Type	a	b	c												
GRM21	1.2	4.0	1.65												
11	Vibration Resistance	Appearance	No defects or abnormalities												
		Capacitance	Within the specified tolerance												
		D.F.	0.01 max.												
			<p>Solder the capacitor to the test jig (glass epoxy board) in the same manner and under the same conditions as (10). The capacitor should be subjected to a simple harmonic motion having a total amplitude of 1.5mm, the frequency being varied uniformly between the approximate limits of 10 and 55Hz. The frequency range, from 10 to 55Hz and return to 10Hz, should be traversed in approximately 1 minute. This motion should be applied for a period of 2 hours in each of 3 mutually perpendicular directions (total of 6 hours).</p>												

Continued on the following page. 



## Specifications and Test Methods

Continued from the preceding page.

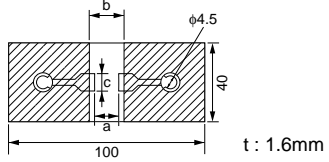
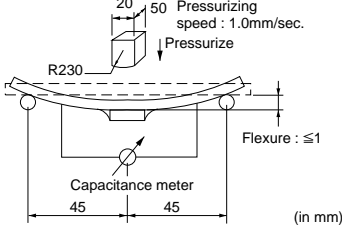
No.	Item	Specifications	Test Method															
12	Deflection	No cracking or marking defects should occur.	Solder the capacitor to the test jig (glass epoxy boards) shown in Fig. 2 using a eutectic solder. Then apply a force in the direction shown in Fig. 3. The soldering should be done either with an iron or using the reflow method and should be conducted with care so that the soldering is uniform and free of defects such as heat shock.															
		 <table border="1" style="margin: 10px auto; border-collapse: collapse;"> <thead> <tr> <th style="padding: 2px;">Type</th> <th style="padding: 2px;">a</th> <th style="padding: 2px;">b</th> <th style="padding: 2px;">c</th> </tr> </thead> <tbody> <tr> <td style="padding: 2px;">GRM21</td> <td style="padding: 2px;">1.2</td> <td style="padding: 2px;">4.0</td> <td style="padding: 2px;">1.65</td> </tr> </tbody> </table> <p style="text-align: center; margin-top: 5px;">(in mm)</p> <p style="text-align: center; margin-top: 5px;">Fig. 2</p>		Type	a	b	c	GRM21	1.2	4.0	1.65							
Type	a	b	c															
GRM21	1.2	4.0	1.65															
		 <p style="text-align: center; margin-top: 5px;">(in mm)</p> <p style="text-align: center; margin-top: 5px;">Fig. 3</p>																
13	Solderability of Termination	75% of the terminations are to be soldered evenly and continuously.	Immerse the capacitor in a solution of ethanol (JIS-K-8101) and rosin (JIS-K-5902) (25% rosin in weight proportion). Preheat at 80 to 120°C for 10 to 30 seconds. After preheating, immerse in eutectic solder solution for 2±0.5 seconds at 230±5°C or Sn-3.0Ag-0.5Cu solder solution for 2±0.5 seconds at 245±5°C.															
14	Resistance to Soldering Heat	Appearance	No defects or abnormalities	Preheat the capacitor at 120 to 150°C for 1 minute. Immerse the capacitor in a eutectic solder or Sn-3.0Ag-0.5Cu solder solution at 270±5°C for 10±0.5 seconds. Let sit at room temperature for 24±2 hours, then measure.														
		Capacitance Change	Within ±7.5%															
		D.F.	0.01 max.															
		I.R.	More than 10,000MΩ															
		Dielectric Strength	No failure															
15	Temperature Cycle	Appearance	No defects or abnormalities	Fix the capacitor to the supporting jig in the same manner and under the same conditions as (11). Perform the five cycles according to the four heat treatments listed in the following table. Let sit for 24±2 hours at room temperature, then measure.														
		Capacitance Change	Within ±7.5%															
		D.F.	0.01 max.															
		I.R.	More than 10,000MΩ															
		Dielectric Strength	No failure															
		<table border="1" style="border-collapse: collapse; margin: 0 auto;"> <thead> <tr> <th style="padding: 2px;">Step</th> <th style="padding: 2px;">1</th> <th style="padding: 2px;">2</th> <th style="padding: 2px;">3</th> <th style="padding: 2px;">4</th> </tr> </thead> <tbody> <tr> <td style="padding: 2px;">Temp. (°C)</td> <td style="padding: 2px;">-25 ±3</td> <td style="padding: 2px;">Room Temp.</td> <td style="padding: 2px;">85 ±3</td> <td style="padding: 2px;">Room Temp.</td> </tr> <tr> <td style="padding: 2px;">Time (min.)</td> <td style="padding: 2px;">30±3</td> <td style="padding: 2px;">2 to 3</td> <td style="padding: 2px;">30±3</td> <td style="padding: 2px;">2 to 3</td> </tr> </tbody> </table>		Step	1	2	3	4	Temp. (°C)	-25 ±3	Room Temp.	85 ±3	Room Temp.	Time (min.)	30±3	2 to 3	30±3	2 to 3
Step	1	2	3	4														
Temp. (°C)	-25 ±3	Room Temp.	85 ±3	Room Temp.														
Time (min.)	30±3	2 to 3	30±3	2 to 3														
16	Humidity, Steady State	Appearance	No defects or abnormalities	Sit the capacitor at 40±2°C and 90 to 95% humidity for 500±12 hours. Remove and let sit for 24±2 hours at room temperature, then measure.														
		Capacitance Change	Within ±12.5%															
		D.F.	0.02 max.															
		I.R.	More than 1,000MΩ															
		Dielectric Strength	No failure															
17	Humidity Load	Appearance	No defects or abnormalities	Apply the rated voltage at 40±2°C and 90 to 95% humidity for 500±12 hours. Remove and let sit for 24±2 hours at room temperature, then measure. The charge/discharge current is less than 50mA.														
		Capacitance Change	Within ±12.5%															
		D.F.	0.02 max.															
		I.R.	More than 500MΩ															
18	High Temperature Load	Appearance	No defects or abnormalities	Apply 200% of the rated voltage for 1,000±12 hours at 85±3°C. Let sit for 24±2 hours at room temperature, then measure. The charge/discharge current is less than 50mA.														
		Capacitance Change	Within ±12.5%															
		D.F.	0.02 max.															
		I.R.	More than 1,000MΩ															

# Chip Monolithic Ceramic Capacitors



## Low ESL LLL/LLA/LLM Series

### ■ Features (Reversed geometry Low ESL Type)

1. Low ESL, good for noise reduction for high frequency
2. Small, high cap

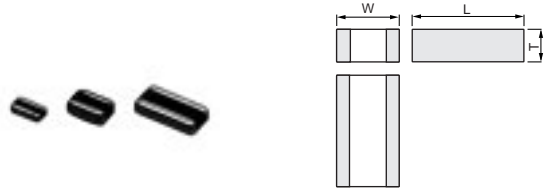

### ■ Applications

1. High speed micro processor
2. High frequency digital equipment

Part Number	Dimensions (mm)		
	L	W	T
LLL185	1.6 ±0.1	0.8 ±0.1	0.6 max.
LLL216	2.0 ±0.1	1.25 ±0.1	0.6 ±0.1
LLL219			0.85 ±0.1
LLL317	3.2 ±0.15	1.6 ±0.15	0.7 ±0.1
LLL31M			1.15 ±0.1

### Reversed geometry Low ESL Type

Part Number	LLL18						LLL21						LLL31											
	L x W						L x W						L x W											
TC	X7R (R7)						X7S (C7)						X7R (R7)						X5R (R6)					
	50 (1H)	25 (1E)	16 (1C)	10 (1A)	6.3 (0J)	4 (0G)	50 (1H)	25 (1E)	16 (1C)	10 (1A)	6.3 (0J)	4 (0G)	50 (1H)	25 (1E)	16 (1C)	10 (1A)	6.3 (0J)	6.3 (0J)						
Capacitance (Capacitance part numbering code) and T (mm) Dimension (T Dimension part numbering code)																								
2200pF (222)	0.5 (5)																							
3300pF (332)	0.5 (5)																							
4700pF (472)	0.5 (5)						0.6 (6)																	
6800pF (682)		0.5 (5)					0.6 (6)																	
10000pF (103)		0.5 (5)	0.5 (5)				0.6 (6)						0.7 (7)											
15000pF (153)		0.5 (5)	0.5 (5)				0.6 (6)						0.7 (7)	0.7 (7)										
22000pF (223)		0.5 (5)	0.5 (5)				0.6 (6)	0.6 (6)					0.7 (7)	0.7 (7)										
33000pF (333)			0.5 (5)				0.85 (9)	0.6 (6)	0.6 (6)				0.7 (7)	0.7 (7)										
47000pF (473)			0.5 (5)					0.6 (6)	0.6 (6)				0.7 (7)	0.7 (7)										
68000pF (683)			0.5 (5)					0.6 (6)	0.6 (6)				0.7 (7)	0.7 (7)										
0.10µF (104)				0.5 (5)				0.6 (6)	0.6 (6)				1.15 (M)	0.7 (7)										
0.15µF (154)					0.5 (5)			0.85 (9)	0.6 (6)				1.15 (M)	0.7 (7)										
0.22µF (224)					0.5 (5)					0.6 (6)				1.15 (M)										
0.33µF (334)						0.5 (5)				0.6 (6)				1.15 (M)	0.7 (7)									
0.47µF (474)						0.5 (5)			0.85 (9)					1.15 (M)	0.7 (7)									

Continued on the following page. ↗

Continued from the preceding page.

Part Number	LLL18						LLL21						LLL31					
L x W	1.6x0.8						2.0x1.25						3.2x1.6					
TC	X7R (R7)			X7S (C7)			X7R (R7)			X7S (C7)			X7R (R7)			X5R (R6)		
Rated Volt.	50 (1H)	25 (1E)	16 (1C)	10 (1A)	6.3 (0J)	4 (0G)	50 (1H)	25 (1E)	16 (1C)	10 (1A)	6.3 (0J)	4 (0G)	50 (1H)	25 (1E)	16 (1C)	10 (1A)	6.3 (0J)	6.3 (0J)
Capacitance (Capacitance part numbering code) and T (mm) Dimension (T Dimension part numbering code)																		
0.68μF (684)												0.85 (9)				1.15 (M)	0.7 (7)	
1.0μF (105)						0.5 (5)						0.85 (9)				1.15 (M)	0.7 (7)	
1.5μF (155)												0.85 (9)				1.15 (M)	0.7 (7)	
2.2μF (225)												0.85 (9)				1.15 (M)	0.7 (7)	
4.7μF (475)																	1.15 (M)	
10μF (106)																		1.25 (B)

The part numbering code is shown in ( ).  
 Dimensions are shown in mm and Rated Voltage in Vdc.

### Reversed geometry Low ESL Type Low Profile

Part Number	LLL18				LLL21						LLL31			
L x W	1.6x0.8				2.0x1.25						3.2x1.6			
TC	X7R (R7)		X7S (C7)		X7R (R7)			X7S (C7)			X7R (R7)			
Rated Volt.	25 (1E)	16 (1C)	10 (1A)	4 (0G)	50 (1H)	25 (1E)	16 (1C)	10 (1A)	6.3 (0J)	4 (0G)	50 (1H)	25 (1E)	16 (1C)	10 (1A)
Capacitance (Capacitance part numbering code) and T (mm) Dimension (T Dimension part numbering code)														
680pF(681)					0.5(5)									
1000pF(102)					0.5(5)									
1500pF(152)					0.5(5)									
2200pF(222)					0.5(5)									
3300pF(332)					0.5(5)									
4700pF(472)					0.5(5)									
6800pF(682)					0.5(5)									
10000pF(103)	0.5(5)	0.5(5)			0.5(5)	0.5(5)					0.5(5)			
15000pF(153)	0.5(5)	0.5(5)			0.5(5)	0.5(5)					0.5(5)	0.5(5)		
22000pF(223)		0.5(5)				0.5(5)	0.5(5)				0.5(5)	0.5(5)		
33000pF(333)		0.5(5)				0.5(5)	0.5(5)				0.5(5)	0.5(5)		
47000pF(473)		0.5(5)					0.5(5)					0.5(5)	0.5(5)	
68000pF(683)			0.5(5)				0.5(5)					0.5(5)	0.5(5)	
0.10μF(104)			0.5(5)				0.5(5)					0.5(5)	0.5(5)	
0.15μF(154)								0.5(5)						0.5(5)
0.22μF(224)				0.5(5)				0.5(5)						0.5(5)
0.33μF(334)				0.5(5)				0.5(5)						0.5(5)
0.47μF(474)									0.5(5)					0.5(5)
0.68μF(684)														0.5(5)
1.0μF(105)										0.5(5)				

The part numbering code is shown in ( ).  
 Dimensions are shown in mm and Rated Voltage in Vdc.

### ■ Features (Eight Terminals Low ESL Type)

1. Low ESL (100pH) , suitable to decoupling capacitor for 1GHz clock speed IC.
2. Small, large cap

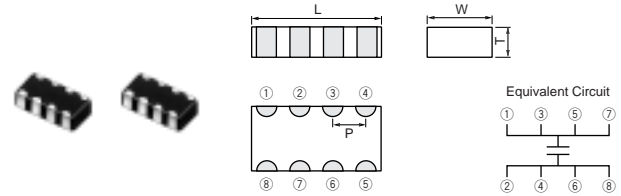

### ■ APPLICATIONS

1. High speed micro processor
2. High frequency digital equipment.

Part Number	Dimensions (mm)			
	L	W	T	P
<b>LLA185</b>	1.6 ±0.1	0.8 ±0.1	0.5 +0.05/-0.1	0.4 ±0.1
<b>LLA215</b>	2.0 ±0.1	1.25 ±0.1	0.5 +0.05/-0.1	0.5 ±0.05
<b>LLA219</b>	2.0 ±0.1	1.25 ±0.1	0.85 ±0.1	0.5 ±0.05
<b>LLA315</b>	3.2 ±0.15	1.6 ±0.15	0.5 +0.05/-0.1	0.8 ±0.1
<b>LLA319</b>	3.2 ±0.15	1.6 ±0.15	0.85 ±0.1	0.8 ±0.1
<b>LLA31M</b>	3.2 ±0.15	1.6 ±0.15	1.15 ±0.1	0.8 ±0.1

## Eight Terminals Low ESL Type

Part Number	LLA18		LLA21				LLA31				
L x W	1.6x0.8		2.0x1.25				3.2x1.6				
TC	X7S (C7)		X7R (R7)				X7S (C7)				
Rated Volt.	4 (0G)		25 (1E)		16 (1C)	10 (1A)	6.3 (0J)	4 (0G)	16 (1C)	10 (1A)	4 (0G)
Capacitance (Capacitance part numbering code) and T (mm) Dimension (T Dimension part numbering code)											
10000pF(103)			0.85(9)								
15000pF(153)			0.85(9)								
22000pF(223)			0.85(9)								
33000pF(333)			0.85(9)								
47000pF(473)			0.85(9)								
68000pF(683)			0.85(9)								
0.10µF(104)			0.85(9)						0.85(9)		
0.15µF(154)			0.85(9)						1.15(M)		
0.22µF(224)			0.85(9)						0.85(9)		
0.33µF(334)	0.5(5)				0.85(9)				0.85(9)		
0.47µF(474)	0.5(5)				0.85(9)				0.85(9)		
0.68µF(684)					0.85(9)				0.85(9)		
1.0µF(105)	0.5(5)						0.85(9)			0.85(9)	
1.5µF(155)							0.85(9)			0.85(9)	
2.2µF(225)								0.85(9)			0.85(9)
4.7µF(475)								0.85(9)			

The part numbering code is shown in ( ).

Dimensions are shown in mm and Rated Voltage in Vdc.

## Eight Terminals Low ESL Type Low Profile

Part Number	LLA21					LLA31		
L x W	2.0x1.25					3.2x1.6		
TC	X7R (R7)				X7S (C7)	X7R (R7)		
Rated Volt.	25 (1E)	16 (1C)	10 (1A)	6.3 (0J)	4 (0G)	16 (1C)	10 (1A)	6.3 (0J)
Capacitance (Capacitance part numbering code) and T (mm) Dimension (T Dimension part numbering code)								
10000pF(103)	0.5(5)							
15000pF(153)	0.5(5)							
22000pF(223)	0.5(5)							
33000pF(333)		0.5(5)						
47000pF(473)		0.5(5)						
68000pF(683)		0.5(5)						
0.10µF(104)		0.5(5)				0.5(5)		
0.15µF(154)			0.5(5)		0.5(5)		0.5(5)	
0.22µF(224)			0.5(5)		0.5(5)		0.5(5)	

Continued on the following page.

 Continued from the preceding page.

Part Number	LLA21					LLA31		
L x W	2.0x1.25					3.2x1.6		
TC	X7R (R7)				X7S (C7)	X7R (R7)		
Rated Volt.	25 (1E)	16 (1C)	10 (1A)	6.3 (0J)	4 (0G)	16 (1C)	10 (1A)	6.3 (0J)
Capacitance (Capacitance part numbering code) and T (mm) Dimension (T Dimension part numbering code)								
0.33μF(334)			0.5(5)	0.5(5)			0.5(5)	
0.47μF(474)				0.5(5)			0.5(5)	
0.68μF(684)				0.5(5)			0.5(5)	
1.0μF(105)					0.5(5)			0.5(5)
1.5μF(155)					0.5(5)			0.5(5)
2.2μF(225)					0.5(5)			0.5(5)

The part numbering code is shown in ( ).  
 Dimensions are shown in mm and Rated Voltage in Vdc.

■ Features (Ten Terminals Low ESL Type)

1. Low ESL (45pH), suitable to decoupling capacitor for 2GHz clock speed IC.
2. Small, large cap

■ APPLICATIONS

1. High speed micro processor
2. High frequency digital equipment

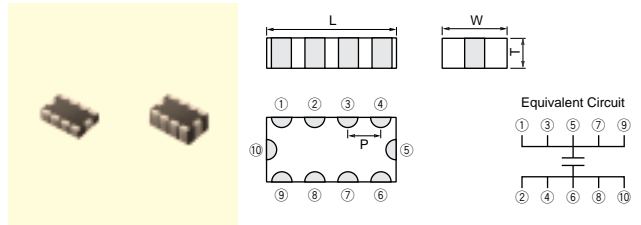

Part Number	Dimensions (mm)			
	L	W	T	P
LLM215	2.0 ±0.1	1.25 ±0.1	0.5 +0.05/-0.1	0.5 ±0.05
LLM219	2.0 ±0.1	1.25 ±0.1	0.85 ±0.1	0.5 ±0.05
LLM315	3.2 ±0.15	1.6 ±0.15	0.5 +0.05/-0.1	0.8 ±0.1
LLM31M	3.2 ±0.15	1.6 ±0.15	1.15 ±0.1	0.8 ±0.1

**Ten Terminals Low ESL Type**

Part Number	LLM21				LLM31		
	L x W						
	2.0x1.25				3.2x1.6		
TC	X7R (R7)			X7S (C7)	X7R (R7)		
Rated Volt.	25 (1E)	16 (1C)	6.3 (0J)	4 (0G)	16 (1C)	10 (1A)	6.3 (0J)
Capacitance (Capacitance part numbering code) and T (mm) Dimension (T Dimension part numbering code)							
10000pF(103)	0.85(9)						
15000pF(153)	0.85(9)						
22000pF(223)	0.85(9)						
33000pF(333)	0.85(9)						
47000pF(473)	0.85(9)						
68000pF(683)		0.85(9)					
0.10µF(104)		0.85(9)			1.15(M)		
0.15µF(154)		0.85(9)			1.15(M)		
0.22µF(224)		0.85(9)			1.15(M)		
0.33µF(334)			0.85(9)		1.15(M)		
0.47µF(474)			0.85(9)		1.15(M)		
0.68µF(684)			0.85(9)		1.15(M)		
1.0µF(105)			0.85(9)		1.15(M)		
1.5µF(155)			0.85(9)			1.15(M)	
2.2µF(225)				0.85(9)		1.15(M)	
3.3µF(335)							1.15(M)
4.7µF(475)							1.15(M)

The part numbering code is shown in ( ).  
 Dimensions are shown in mm and Rated Voltage in Vdc.

**Ten Terminals Low ESL Type Low Profile**

Part Number	LLM21				LLM31		
	L x W						
	2.0x1.25				3.2x1.6		
TC	X7R (R7)			X7S (C7)	X7R (R7)		
Rated Volt.	25 (1E)	16 (1C)	6.3 (0J)	4 (0G)	16 (1C)	10 (1A)	6.3 (0J)
Capacitance (Capacitance part numbering code) and T (mm) Dimension (T Dimension part numbering code)							
10000pF(103)	0.5(5)						
15000pF(153)	0.5(5)						
22000pF(223)	0.5(5)						
33000pF(333)		0.5(5)					
47000pF(473)		0.5(5)					
68000pF(683)		0.5(5)					
0.10µF(104)		0.5(5)			0.5(5)		
0.15µF(154)			0.5(5)		0.5(5)		

Continued on the following page.

Continued from the preceding page.

Part Number	LLM21				LLM31		
L x W	2.0x1.25				3.2x1.6		
TC	X7R (R7)			X7S (C7)	X7R (R7)		
Rated Volt.	25 (1E)	16 (1C)	6.3 (0J)	4 (0G)	16 (1C)	10 (1A)	6.3 (0J)
Capacitance (Capacitance part numbering code) and T (mm) Dimension (T Dimension part numbering code)							
0.22μF(224)			0.5(5)		0.5(5)		
0.33μF(334)			0.5(5)			0.5(5)	
0.47μF(474)			0.5(5)			0.5(5)	
0.68μF(684)			0.5(5)			0.5(5)	
1.0μF(105)				0.5(5)			
1.5μF(155)				0.5(5)			
2.2μF(225)				0.5(5)			0.5(5)

The part numbering code is shown in ( ).  
 Dimensions are shown in mm and Rated Voltage in Vdc.

## Specifications and Test Methods

No.	Item	Specifications	Test Method																												
1	Operating Temperature Range	R6 : -55 to +85°C R7, C7 : -55 to +125°C																													
2	Rated Voltage	See the previous pages.	The rated voltage is defined as the maximum voltage which may be applied continuously to the capacitor. When AC voltage is superimposed on DC voltage, $V^{P-P}$ or $V^{O-P}$ , whichever is larger, should be maintained within the rated voltage range.																												
3	Appearance	No defects or abnormalities	Visual inspection																												
4	Dimensions	Within the specified dimension	Using calipers																												
5	Dielectric Strength	No defects or abnormalities	No failure should be observed when 250% of the rated voltage is applied between the terminations for 1 to 5 seconds, provided the charge/discharge current is less than 50mA.																												
6	Insulation Resistance	More than 10,000MΩ or 500Ω · F (Whichever is smaller)	The insulation resistance should be measured with a DC voltage not exceeding the rated voltage at 25°C and 75%RH max. and within 2 minutes of charging.																												
7	Capacitance	Within the specified tolerance	The capacitance/D.F. should be measured at 25°C at the frequency and voltage shown in the table.																												
8	Dissipation Factor (D.F.)	W.V.: 25V min.; 0.025 max. W.V.: 16V max.; 0.035 max. *1	<table border="1"> <thead> <tr> <th>Capacitance</th> <th>Frequency</th> <th>Voltage</th> </tr> </thead> <tbody> <tr> <td>C≤10μF (10V min.)</td> <td>1±0.1kHz</td> <td>1.0±0.2Vrms</td> </tr> <tr> <td>C≤10μF (6.3V max.)</td> <td>1±0.1kHz</td> <td>0.5±0.1Vrms</td> </tr> <tr> <td>C&gt;10μF</td> <td>120±24kHz</td> <td>0.5±0.1Vrms</td> </tr> </tbody> </table>	Capacitance	Frequency	Voltage	C≤10μF (10V min.)	1±0.1kHz	1.0±0.2Vrms	C≤10μF (6.3V max.)	1±0.1kHz	0.5±0.1Vrms	C>10μF	120±24kHz	0.5±0.1Vrms																
			Capacitance	Frequency	Voltage																										
C≤10μF (10V min.)	1±0.1kHz	1.0±0.2Vrms																													
C≤10μF (6.3V max.)	1±0.1kHz	0.5±0.1Vrms																													
C>10μF	120±24kHz	0.5±0.1Vrms																													
9	Capacitance Temperature Characteristics	<table border="1"> <thead> <tr> <th>Char.</th> <th>Temp. Range (°C)</th> <th>Reference Temp.</th> <th>Cap.Change</th> </tr> </thead> <tbody> <tr> <td>R6</td> <td>-55 to +85</td> <td>25°C</td> <td>Within ±15%</td> </tr> <tr> <td>R7</td> <td>-55 to +125</td> <td>25°C</td> <td>Within ±15%</td> </tr> <tr> <td>C7</td> <td>-55 to +125</td> <td>25°C</td> <td>Within ±22%</td> </tr> </tbody> </table>	Char.	Temp. Range (°C)	Reference Temp.	Cap.Change	R6	-55 to +85	25°C	Within ±15%	R7	-55 to +125	25°C	Within ±15%	C7	-55 to +125	25°C	Within ±22%	<p>The capacitance change should be measured after 5 min. at each specified temperature stage.</p> <table border="1"> <thead> <tr> <th>Step</th> <th>Temperature (°C)</th> </tr> </thead> <tbody> <tr> <td>1</td> <td>25±2</td> </tr> <tr> <td>2</td> <td>-55±3</td> </tr> <tr> <td>3</td> <td>25±2</td> </tr> <tr> <td>4</td> <td>125±3</td> </tr> <tr> <td>5</td> <td>25±2</td> </tr> </tbody> </table> <p>The ranges of capacitance change compared with the 25°C value over the temperature ranges shown in the table should be within the specified ranges.</p>	Step	Temperature (°C)	1	25±2	2	-55±3	3	25±2	4	125±3	5	25±2
Char.	Temp. Range (°C)	Reference Temp.	Cap.Change																												
R6	-55 to +85	25°C	Within ±15%																												
R7	-55 to +125	25°C	Within ±15%																												
C7	-55 to +125	25°C	Within ±22%																												
Step	Temperature (°C)																														
1	25±2																														
2	-55±3																														
3	25±2																														
4	125±3																														
5	25±2																														
10	Adhesive Strength of Termination	No removal of the terminations or other defect should occur.	Solder the capacitor to the test jig (glass epoxy board) using a eutectic solder. Then apply 5N force in parallel with the test jig for 10±1 sec. The soldering should be done either with an iron or using the reflow method and should be conducted with care so that the soldering is uniform and free of defects such as heat shock.																												
11	Vibration Resistance	Appearance	No defects or abnormalities																												
		Capacitance	Within the specified tolerance																												
		D.F.	W.V.: 25V min.; 0.025 max. W.V.: 16V max.; 0.035 max. *1																												
12	Solderability of Termination	75% of the terminations are to be soldered evenly and continuously.	Immerse the capacitor in a solution of ethanol (JIS-K-8101) and rosin (JIS-K-5902) (25% rosin in weight proportion). Preheat at 80 to 120°C for 10 to 30 seconds. After preheating, immerse in eutectic solder solution for 2±0.5 seconds at 230±5°C, or Sn-3.0Ag-0.5Cu solder solution for 2±0.5 seconds at 245±5°C.																												
13	Resistance to Soldering Heat	Appearance	No marking defects																												
		Capacitance Change	Within ±7.5%																												
		D.F.	W.V.: 25V min.; 0.025 max. W.V.: 16V max.; 0.035 max. *1																												
		I.R.	More than 10,000MΩ or 500Ω · F (Whichever is smaller)																												
		Dielectric Strength	No failure																												
			<p>Preheat the capacitor at 120 to 150°C for 1 minute. Immerse the capacitor in a eutectic solder or Sn-3.0Ag-0.5Cu solder solution at 270±5°C for 10±0.5 seconds solution at 270±5°C for 10±0.5 seconds. Let sit at room temperature for 48±4 hours, then measure.</p> <ul style="list-style-type: none"> <li>Initial measurement.</li> </ul> <p>Perform a heat treatment at 150±9.0°C for one hour and then let sit for 48±4 hours at room temperature. Perform the initial measurement.</p>																												

Continued on the following page. 



## Specifications and Test Methods

Continued from the preceding page.

No.	Item	Specifications	Test Method															
14	Temperature Cycle	Appearance	Fix the capacitor to the supporting jig in the same manner and under the same conditions as (10). Perform the five cycles according to the four heat treatments listed in the following table. Let sit for 48±4 hours at room temperature, then measure. <table border="1" style="margin: 10px 0;"> <thead> <tr> <th>Step</th> <th>1</th> <th>2</th> <th>3</th> <th>4</th> </tr> </thead> <tbody> <tr> <td>Temp. (°C)</td> <td>Min. Operating Temp. <math>\pm 3</math></td> <td>Room Temp.</td> <td>Max. Operating Temp. <math>\pm 3</math></td> <td>Room Temp.</td> </tr> <tr> <td>Time (min.)</td> <td>30±3</td> <td>2 to 3</td> <td>30±3</td> <td>2 to 3</td> </tr> </tbody> </table>	Step	1	2	3	4	Temp. (°C)	Min. Operating Temp. $\pm 3$	Room Temp.	Max. Operating Temp. $\pm 3$	Room Temp.	Time (min.)	30±3	2 to 3	30±3	2 to 3
		Step		1	2	3	4											
		Temp. (°C)		Min. Operating Temp. $\pm 3$	Room Temp.	Max. Operating Temp. $\pm 3$	Room Temp.											
		Time (min.)		30±3	2 to 3	30±3	2 to 3											
		Capacitance Change		Within ±7.5% *1														
D.F.	W.V.: 25V min.; 0.025 max. W.V.: 16V max.; 0.035 max. *1																	
I.R.	More than 10,000MΩ or 500Ω · F (Whichever is smaller)																	
	Dielectric Strength	No failure																
15	Humidity (Steady State)	Appearance	Sit the capacitor at 40±2°C and 90 to 95% humidity for 500±12 hours. Remove and let sit for 48±4 hours at room temperature, then measure.															
		Capacitance Change		Within ±12.5% *1														
		D.F.		0.05 max. *1														
		I.R.		More than 1,000MΩ or 50Ω · F (Whichever is smaller)														
16	Humidity Load	Appearance	Apply the rated voltage at 40±2°C and 90 to 95% humidity for 500±12 hours. Remove and let sit for 48±4 hours at room temperature, then measure. The charge/discharge current is less than 50mA.															
		Capacitance Change		Within ±12.5% *1														
		D.F.		0.05 max. *1														
		I.R.		More than 500MΩ or 25Ω · F *1 (Whichever is smaller)														
		Dielectric Strength		No failure														
17	High Temperature Load	Appearance	Apply 200% of the rated voltage for 1000±12 hours at the maximum operating temperature ±3°C. Let sit for 48±4 hours at room temperature, then measure. The charge/discharge current is less than 50mA. <p>•Initial measurement.                      Apply 200% (*2) of the rated DC voltage for one hour at the maximum operating temperature ±3°C. Remove and let sit for 48±4 hours at room temperature.                      Perform initial measurement. (*1)</p>															
		Capacitance Change		Within ±12.5% *1														
		D.F.		W.V.: 25V min.; 0.04 max. W.V.: 16V max.; 0.05 max. *1														
		I.R.		More than 1,000MΩ or 50Ω · F *1 (Whichever is smaller)														
		Dielectric Strength		No failure														

\*1 : The figure Indicates typical inspection. Please refer to individual specifications.

\*2 : Some of the parts are applicable in rated voltage×150%. Please refer to individual specifications.

# Chip Monolithic Ceramic Capacitors



## High Frequency for Flow/Reflow Soldering GQM Series

### ■ Features

1. HiQ and low ESR at VHF, UHF, Microwave
2. Feature improvement, low power consumption for mobile telecommunication. (Base station, terminal, etc.)

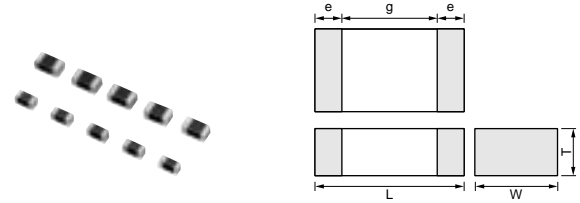

### ■ Applicatons

High frequency circuit (Mobile telecommunication, etc.)

Part Number	Dimensions (mm)				
	L	W	T	e	g min.
<b>GQM188</b>	1.6 ±0.1	0.8 ±0.1	0.8 ±0.1	0.2 to 0.5	0.5
<b>GQM219</b>	2.0 ±0.1	1.25 ±0.1	0.85 ±0.1	0.2 to 0.7	0.7

Part Number	<b>GQM18</b>		<b>GQM21</b>	
	1.60x0.80		2.00x1.25	
L x W	COG (5C)		COG (5C)	
TC	COG (5C)		COG (5C)	
Rated Volt.	100 (2A)	50 (1H)	100 (2A)	50 (1H)
Capacitance (Capacitance part numbering code) and T (mm) Dimension (T Dimension part numbering code)				
0.50pF( <b>R50</b> )	0.80( <b>8</b> )		0.85( <b>9</b> )	
0.75pF( <b>R75</b> )	0.80( <b>8</b> )		0.85( <b>9</b> )	
1.0pF( <b>1R0</b> )	0.80( <b>8</b> )		0.85( <b>9</b> )	
1.1pF( <b>1R1</b> )	0.80( <b>8</b> )		0.85( <b>9</b> )	
1.2pF( <b>1R2</b> )	0.80( <b>8</b> )		0.85( <b>9</b> )	
1.3pF( <b>1R3</b> )	0.80( <b>8</b> )		0.85( <b>9</b> )	
1.5pF( <b>1R5</b> )	0.80( <b>8</b> )		0.85( <b>9</b> )	
1.6pF( <b>1R6</b> )	0.80( <b>8</b> )		0.85( <b>9</b> )	
1.8pF( <b>1R8</b> )	0.80( <b>8</b> )		0.85( <b>9</b> )	
2.0pF( <b>2R0</b> )	0.80( <b>8</b> )		0.85( <b>9</b> )	
2.2pF( <b>2R2</b> )	0.80( <b>8</b> )		0.85( <b>9</b> )	
2.4pF( <b>2R4</b> )	0.80( <b>8</b> )		0.85( <b>9</b> )	
2.7pF( <b>2R7</b> )	0.80( <b>8</b> )		0.85( <b>9</b> )	
3.0pF( <b>3R0</b> )	0.80( <b>8</b> )		0.85( <b>9</b> )	
3.3pF( <b>3R3</b> )	0.80( <b>8</b> )		0.85( <b>9</b> )	
3.6pF( <b>3R6</b> )	0.80( <b>8</b> )		0.85( <b>9</b> )	
3.9pF( <b>3R9</b> )	0.80( <b>8</b> )		0.85( <b>9</b> )	
4.0pF( <b>4R0</b> )	0.80( <b>8</b> )		0.85( <b>9</b> )	
4.3pF( <b>4R3</b> )	0.80( <b>8</b> )		0.85( <b>9</b> )	
4.7pF( <b>4R7</b> )	0.80( <b>8</b> )		0.85( <b>9</b> )	
5.0pF( <b>5R0</b> )	0.80( <b>8</b> )		0.85( <b>9</b> )	
5.1pF( <b>5R1</b> )	0.80( <b>8</b> )		0.85( <b>9</b> )	
5.6pF( <b>5R6</b> )	0.80( <b>8</b> )		0.85( <b>9</b> )	
6.0pF( <b>6R0</b> )	0.80( <b>8</b> )		0.85( <b>9</b> )	
6.2pF( <b>6R2</b> )	0.80( <b>8</b> )		0.85( <b>9</b> )	
6.8pF( <b>6R8</b> )	0.80( <b>8</b> )		0.85( <b>9</b> )	
7.0pF( <b>7R0</b> )		0.80( <b>8</b> )	0.85( <b>9</b> )	
7.5pF( <b>7R5</b> )		0.80( <b>8</b> )	0.85( <b>9</b> )	
8.0pF( <b>8R0</b> )		0.80( <b>8</b> )	0.85( <b>9</b> )	
8.2pF( <b>8R2</b> )		0.80( <b>8</b> )	0.85( <b>9</b> )	
9.0pF( <b>9R0</b> )		0.80( <b>8</b> )	0.85( <b>9</b> )	
9.1pF( <b>9R1</b> )		0.80( <b>8</b> )	0.85( <b>9</b> )	
10pF( <b>100</b> )		0.80( <b>8</b> )	0.85( <b>9</b> )	

13

Continued on the following page.



Continued from the preceding page.

Part Number	GQM18		GQM21	
L x W	1.60x0.80		2.00x1.25	
TC	COG (5C)		COG (5C)	
Rated Volt.	100 (2A)	50 (1H)	100 (2A)	50 (1H)
Capacitance (Capacitance part numbering code) and T (mm) Dimension (T Dimension part numbering code)				
11pF(110)		0.80(8)	0.85(9)	
12pF(120)		0.80(8)	0.85(9)	
13pF(130)		0.80(8)	0.85(9)	
15pF(150)		0.80(8)	0.85(9)	
16pF(160)		0.80(8)	0.85(9)	
18pF(180)		0.80(8)	0.85(9)	
20pF(200)		0.80(8)		0.85(9)
22pF(220)		0.80(8)		0.85(9)
24pF(240)		0.80(8)		0.85(9)
27pF(270)		0.80(8)		0.85(9)
30pF(300)		0.80(8)		0.85(9)
33pF(330)		0.80(8)		0.85(9)
36pF(360)		0.80(8)		0.85(9)
39pF(390)		0.80(8)		0.85(9)
43pF(430)		0.80(8)		0.85(9)
47pF(470)		0.80(8)		0.85(9)
51pF(510)		0.80(8)		0.85(9)
56pF(560)		0.80(8)		0.85(9)
62pF(620)		0.80(8)		0.85(9)
68pF(680)		0.80(8)		0.85(9)
75pF(750)		0.80(8)		0.85(9)
82pF(820)		0.80(8)		0.85(9)
91pF(910)		0.80(8)		0.85(9)
100pF(101)		0.80(8)		0.85(9)

The part numbering code is shown in ( ).  
 Dimensions are shown in mm and Rated Voltage in Vdc.

■ Q-Frequency Characteristics

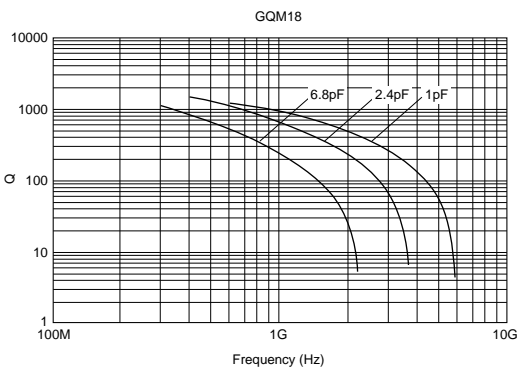

■ Resonant Frequency-Capacitance

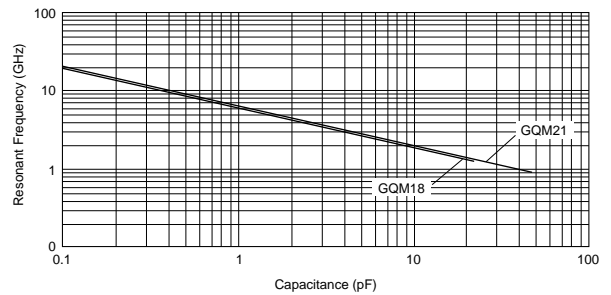

## Specifications and Test Methods

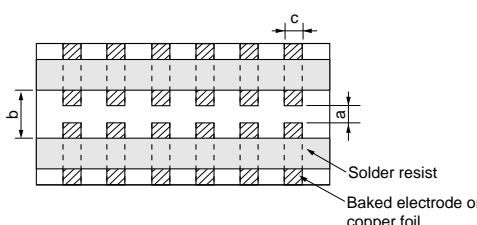
No.	Item	Specifications	Test Method																		
1	Operating Temperature	-55 to 125°C	Reference Temperature : 25°C (2C, 3C, 4C : 20°C)																		
2	Rated Voltage	See the previous page.	The rated voltage is defined as the maximum voltage which may be applied continuously to the capacitor. When AC voltage is superimposed on DC voltage, $V^{P-P}$ or $V^{O-P}$ , whichever is larger, should be maintained within the rated voltage range.																		
3	Appearance	No defects or abnormalities	Visual inspection																		
4	Dimension	Within the specified dimensions	Using calipers																		
5	Dielectric Strength	No defects or abnormalities	No failure should be observed when 300% of the rated voltage is applied between the terminations for 1 to 5 seconds, provided the charge/discharge current is less than 50mA.																		
6	Insulation Resistance	More than 10,000MΩ (Whichever is smaller)	The insulation resistance should be measured with a DC voltage not exceeding the rated voltage at 25°C and 75%RH max. and within 2 minutes of charging.																		
7	Capacitance	Within the specified tolerance	The capacitance/Q should be measured at 25°C at the frequency and voltage shown in the table.																		
8	Q	30pF min. : $Q \geq 1400$ 30pF max. : $Q \geq 800+20C$ C : Nominal Capacitance (pF)	<table border="1"> <tr> <td>Frequency</td> <td>1±0.1MHz</td> </tr> <tr> <td>Voltage</td> <td>0.5 to 5Vrms</td> </tr> </table>	Frequency	1±0.1MHz	Voltage	0.5 to 5Vrms														
		Frequency	1±0.1MHz																		
Voltage	0.5 to 5Vrms																				
9	Capacitance Temperature Characteristics	<table border="1"> <tr> <td>Capacitance Change</td> <td>Within the specified tolerance (Table A)</td> </tr> <tr> <td>Temperature Coefficient</td> <td>Within the specified tolerance (Table A)</td> </tr> <tr> <td>Capacitance Drift</td> <td>Within ±0.2% or ±0.05pF (Whichever is larger)</td> </tr> </table>	Capacitance Change	Within the specified tolerance (Table A)	Temperature Coefficient	Within the specified tolerance (Table A)	Capacitance Drift	Within ±0.2% or ±0.05pF (Whichever is larger)	<p>The temperature coefficient is determined using the capacitance measured in step 3 as a reference.</p> <p>When cycling the temperature sequentially from step 1 through 5 the capacitance should be within the specified tolerance for the temperature coefficient and capacitance change as in Table A. The capacitance drift is calculated by dividing the differences between the maximum and minimum measured values in the steps 1, 3 and 5 by the capacitance value in step 3.</p> <table border="1"> <thead> <tr> <th>Step</th> <th>Temperature (°C)</th> </tr> </thead> <tbody> <tr> <td>1</td> <td>Reference Temp. ±2</td> </tr> <tr> <td>2</td> <td>-55±3</td> </tr> <tr> <td>3</td> <td>Reference Temp. ±2</td> </tr> <tr> <td>4</td> <td>125±3</td> </tr> <tr> <td>5</td> <td>Reference Temp. ±2</td> </tr> </tbody> </table>	Step	Temperature (°C)	1	Reference Temp. ±2	2	-55±3	3	Reference Temp. ±2	4	125±3	5	Reference Temp. ±2
Capacitance Change	Within the specified tolerance (Table A)																				
Temperature Coefficient	Within the specified tolerance (Table A)																				
Capacitance Drift	Within ±0.2% or ±0.05pF (Whichever is larger)																				
Step	Temperature (°C)																				
1	Reference Temp. ±2																				
2	-55±3																				
3	Reference Temp. ±2																				
4	125±3																				
5	Reference Temp. ±2																				
10	Adhesive Strength of Termination	No removal of the terminations or other defect should occur.	<p>Solder the capacitor to the test jig (glass epoxy board) shown in Fig. 1 using a eutectic solder. Then apply 10N* force in parallel with the test jig for 10±1 sec.</p> <p>The soldering should be done either with an iron or using the reflow method and should be conducted with care so that the soldering is uniform and free of defects such as heat shock.</p> <p>*5N (GQM188)</p> <table border="1"> <thead> <tr> <th>Type</th> <th>a</th> <th>b</th> <th>c</th> </tr> </thead> <tbody> <tr> <td>GQM18</td> <td>1.0</td> <td>3.0</td> <td>1.2</td> </tr> <tr> <td>GQM21</td> <td>1.2</td> <td>4.0</td> <td>1.65</td> </tr> </tbody> </table> <p>(in mm)</p> <p>Fig. 1</p>	Type	a	b	c	GQM18	1.0	3.0	1.2	GQM21	1.2	4.0	1.65						
		Type		a	b	c															
GQM18	1.0	3.0	1.2																		
GQM21	1.2	4.0	1.65																		
																					
11	Vibration Resistance	Appearance	No defects or abnormalities																		
		Capacitance	Within the specified tolerance																		
		Q	30pF min. : $Q \geq 1400$ 30pF max. : $Q \geq 800+20C$ C : Nominal Capacitance (pF)																		
		Solder the capacitor to the test jig (glass epoxy board) in the same manner and under the same conditions as (10). The capacitor should be subjected to a simple harmonic motion having a total amplitude of 1.5mm, the frequency being varied uniformly between the approximate limits of 10 and 55Hz. The frequency range, from 10 to 55Hz and return to 10Hz, should be traversed in approximately 1 minute. This motion should be applied for a period of 2 hours in each of 3 mutually perpendicular directions (total of 6 hours).																			

Continued on the following page. 

## Specifications and Test Methods

Continued from the preceding page.

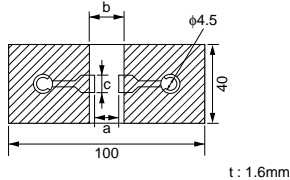
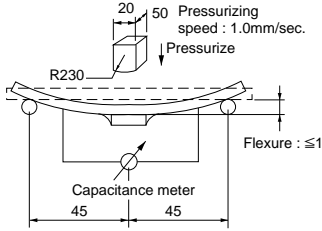
No.	Item	Specifications	Test Method															
12	Deflection	No crack or marked defect should occur.	Solder the capacitor on the test jig (glass epoxy board) shown in Fig. 2 using a eutectic solder. Then apply a force in the direction shown in Fig. 3. The soldering should be done either with an iron or using the reflow method and should be conducted with care so that the soldering is uniform and free of defects such as heat shock.															
		 <table border="1" style="margin: 10px auto; border-collapse: collapse;"> <thead> <tr> <th style="text-align: center;">Type</th> <th style="text-align: center;">a</th> <th style="text-align: center;">b</th> <th style="text-align: center;">c</th> </tr> </thead> <tbody> <tr> <td style="text-align: center;">GQM18</td> <td style="text-align: center;">1.0</td> <td style="text-align: center;">3.0</td> <td style="text-align: center;">1.2</td> </tr> <tr> <td style="text-align: center;">GQM21</td> <td style="text-align: center;">1.2</td> <td style="text-align: center;">4.0</td> <td style="text-align: center;">1.65</td> </tr> </tbody> </table> <p style="text-align: center;">(in mm)</p>		Type	a	b	c	GQM18	1.0	3.0	1.2	GQM21	1.2	4.0	1.65			
Type	a	b	c															
GQM18	1.0	3.0	1.2															
GQM21	1.2	4.0	1.65															
		Fig. 2	 <p style="text-align: center;">Fig. 3</p>															
13	Solderability of Termination	75% of the terminations are to be soldered evenly and continuously.	Immerse the capacitor in a solution of ethanol (JIS-K-8101) and rosin (JIS-K-5902) (25% rosin in weight proportion). Preheat at 80 to 120°C for 10 to 30 seconds. After preheating, immerse in eutectic solder solution for 2±0.5 seconds at 230±5°C or Sn-3.0Ag-0.5Cu solder solution for 2±0.5 seconds at 245±5°C.															
14	Resistance to Soldering Heat	The measured and observed characteristics should satisfy the specifications in the following table.	Preheat the capacitor at 120 to 150°C for 1 minute. Immerse the capacitor in a eutectic solder or Sn-3.0Ag-0.5Cu solder solution at 270±5°C for 10±0.5 seconds. Let sit at room temperature for 24±2 hours.															
		<table border="1" style="width: 100%; border-collapse: collapse;"> <tr> <td style="width: 15%;">Appearance</td> <td>No marking defects</td> </tr> <tr> <td>Capacitance Change</td> <td>Within ±2.5% or ±0.25 pF (Whichever is larger)</td> </tr> <tr> <td>Q</td> <td>30pF min. : Q ≥ 1400 30pF max. : Q ≥ 800+20C C : Nominal Capacitance (pF)</td> </tr> <tr> <td>I.R.</td> <td>More than 10,000MΩ</td> </tr> <tr> <td>Dielectric Strength</td> <td>No failure</td> </tr> </table>		Appearance	No marking defects	Capacitance Change	Within ±2.5% or ±0.25 pF (Whichever is larger)	Q	30pF min. : Q ≥ 1400 30pF max. : Q ≥ 800+20C C : Nominal Capacitance (pF)	I.R.	More than 10,000MΩ	Dielectric Strength	No failure					
		Appearance		No marking defects														
		Capacitance Change		Within ±2.5% or ±0.25 pF (Whichever is larger)														
		Q		30pF min. : Q ≥ 1400 30pF max. : Q ≥ 800+20C C : Nominal Capacitance (pF)														
I.R.	More than 10,000MΩ																	
Dielectric Strength	No failure																	
Appearance	No marking defects																	
Capacitance Change	Within ±2.5% or ±0.25pF (Whichever is larger)																	
Q	30pF min. : Q ≥ 1400 30pF max. : Q ≥ 800+20C C : Nominal Capacitance (pF)																	
I.R.	More than 10,000MΩ																	
Dielectric Strength	No failure																	
15	Temperature Cycle	The measured and observed characteristics should satisfy the specifications in the following table.	Fix the capacitor to the supporting jig in the same manner and under the same conditions as (10). Perform the five cycles according to the four heat treatments listed in the following table. Let sit for 24±2 hours at room temperature, then measure.															
		Appearance		No marking defects														
		Capacitance Change		Within ±2.5% or ±0.25pF (Whichever is larger)														
		Q		30pF min. : Q ≥ 1400 30pF max. : Q ≥ 800+20C C : Nominal Capacitance (pF)														
		I.R.		More than 10,000MΩ														
Dielectric Strength	No failure																	
			<table border="1" style="width: 100%; border-collapse: collapse;"> <thead> <tr> <th style="width: 10%;">Step</th> <th style="width: 15%;">1</th> <th style="width: 15%;">2</th> <th style="width: 15%;">3</th> <th style="width: 15%;">4</th> </tr> </thead> <tbody> <tr> <td>Temp. (°C)</td> <td>Min. Operating Temp. +0/-3</td> <td>Room Temp.</td> <td>Max. Operating Temp. +3/-0</td> <td>Room Temp.</td> </tr> <tr> <td>Time (min.)</td> <td>30±3</td> <td>2 to 3</td> <td>30±3</td> <td>2 to 3</td> </tr> </tbody> </table>	Step	1	2	3	4	Temp. (°C)	Min. Operating Temp. +0/-3	Room Temp.	Max. Operating Temp. +3/-0	Room Temp.	Time (min.)	30±3	2 to 3	30±3	2 to 3
Step	1	2	3	4														
Temp. (°C)	Min. Operating Temp. +0/-3	Room Temp.	Max. Operating Temp. +3/-0	Room Temp.														
Time (min.)	30±3	2 to 3	30±3	2 to 3														
16	Humidity Steady State	The measured and observed characteristics should satisfy the specifications in the following table.	Let the capacitor sit at 40±2°C and 90 to 95% humidity for 500±12 hours. Remove and let sit for 24±2 hours (temperature compensating type) at room temperature, then measure.															
		Appearance		No marking defects														
		Capacitance Change		Within ±5% or ±0.5pF (Whichever is larger)														
		Q		30pF min. : Q ≥ 350 10pF and over, 30pF and below : Q ≥ 275+5C/2 10pF max. : Q ≥ 200+10C C : Nominal Capacitance (pF)														
		I.R.		More than 1,000MΩ														
Dielectric Strength	No failure																	

Continued on the following page.

## Specifications and Test Methods

Continued from the preceding page.

No.	Item	Specifications	Test Method	
17	Humidity Load	The measured and observed characteristics should satisfy the specifications in the following table.	Apply the rated voltage at 40±2°C and 90 to 95% humidity for 500±12 hours. Remove and let sit for 24±2 hours at room temperature then measure. The charge/discharge current is less than 50mA.	
		Appearance		No marking defects
		Capacitance Change		Within ±7.5% or ±0.75pF (Whichever is larger)
		Q		30pF min. : $Q \geq 200$ 30pF max. : $Q \geq 100 + 10C/3$ C : Nominal Capacitance (pF)
		I.R.		More than 500MΩ
18	High Temperature Load	The measured and observed characteristics should satisfy the specifications in the following table.	Apply 200% of the rated voltage for 1000±12 hours at the maximum operating temperature ±3°C. Let sit for 24±2 hours (temperature compensating type) at room temperature, then measure. The charge/discharge current is less than 50mA.	
		Appearance		No marking defects
		Capacitance Change		Within ±3% or ±0.3pF (Whichever is larger)
		Q		30pF min. : $Q \geq 350$ 10pF and over, 30pF and below : $Q \geq 275 + 5C/2$ 10pF max. : $Q \geq 200 + 10C$ C : Nominal Capacitance (pF)
		I.R.		More than 1,000MΩ
	Dielectric Strength	No failure		

Table A  
(1)

Char.	Nominal Values (ppm/°C) *1	Capacitance Change from 25°C (%)					
		-55°C		-30°C		-10°C	
		Max.	Min.	Max.	Min.	Max.	Min.
5C	0±30	0.58	-0.24	0.40	-0.17	0.25	-0.11

\*1 : Nominal values denote the temperature coefficient within a range of 25 to 125°C.

13

# Chip Monolithic Ceramic Capacitors



## High Frequency Type ERB Series

### SMD Type

#### ■ Features (ERB Series)

1. Negligible inductance is achieved by its monolithic structure so the series can be used at frequencies above 1GHz.
2. Nickel barriered terminations of ERB series improve solderability and decrease solder leaching.
3. ERB18/21 series are designed for both flow and reflow soldering and ERB32 series are designed for reflow soldering.

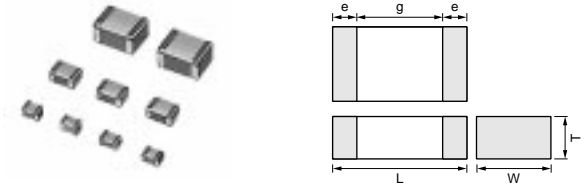

Part Number	Dimensions (mm)				
	L	W	T max.	e min.	g min.
<b>ERB188</b>	1.6±0.1	0.8±0.1	0.9	0.2	0.5
<b>ERB21B</b>	2.0±0.3	1.25±0.3	1.35	0.25	0.7
<b>ERB32Q</b>	3.2±0.3	2.5±0.3	1.7	0.3	1.0

#### ■ Applications

High frequency and high-power circuits

Part Number	<b>ERB18</b>		<b>ERB21</b>			<b>ERB32</b>			
L x W	1.6x0.8		2.0x1.25			3.2x2.5			
TC	COG (5C)		COG (5C)			COG (5C)			
Rated Volt.	250 (2E)	250 (2E)	100 (2A)	50 (1H)	500 (2H)	300 (YD)	250 (2E)	100 (2A)	50 (1H)
Capacitance (Capacitance part numbering code) and T (mm) Dimension (T Dimension part numbering code)									
0.50pF( <b>R50</b> )	0.8( <b>B</b> )	1.25( <b>B</b> )			1.50( <b>Q</b> )				
0.75pF( <b>R75</b> )	0.8( <b>B</b> )	1.25( <b>B</b> )			1.50( <b>Q</b> )				
1.0pF( <b>1R0</b> )	0.8( <b>B</b> )	1.25( <b>B</b> )			1.50( <b>Q</b> )				
1.1pF( <b>1R1</b> )	0.8( <b>B</b> )	1.25( <b>B</b> )			1.50( <b>Q</b> )				
1.2pF( <b>1R2</b> )	0.8( <b>B</b> )	1.25( <b>B</b> )			1.50( <b>Q</b> )				
1.3pF( <b>1R3</b> )	0.8( <b>B</b> )	1.25( <b>B</b> )			1.50( <b>Q</b> )				
1.5pF( <b>1R5</b> )	0.8( <b>B</b> )	1.25( <b>B</b> )			1.50( <b>Q</b> )				
1.6pF( <b>1R6</b> )	0.8( <b>B</b> )	1.25( <b>B</b> )			1.50( <b>Q</b> )				
1.8pF( <b>1R8</b> )	0.8( <b>B</b> )	1.25( <b>B</b> )			1.50( <b>Q</b> )				
2.0pF( <b>2R0</b> )	0.8( <b>B</b> )	1.25( <b>B</b> )			1.50( <b>Q</b> )				
2.2pF( <b>2R2</b> )	0.8( <b>B</b> )	1.25( <b>B</b> )			1.50( <b>Q</b> )				
2.4pF( <b>2R4</b> )	0.8( <b>B</b> )	1.25( <b>B</b> )			1.50( <b>Q</b> )				
2.7pF( <b>2R7</b> )	0.8( <b>B</b> )	1.25( <b>B</b> )			1.50( <b>Q</b> )				
3.0pF( <b>3R0</b> )	0.8( <b>B</b> )	1.25( <b>B</b> )			1.50( <b>Q</b> )				
3.3pF( <b>3R3</b> )	0.8( <b>B</b> )	1.25( <b>B</b> )			1.50( <b>Q</b> )				
3.6pF( <b>3R6</b> )	0.8( <b>B</b> )	1.25( <b>B</b> )			1.50( <b>Q</b> )				
3.9pF( <b>3R9</b> )	0.8( <b>B</b> )	1.25( <b>B</b> )			1.50( <b>Q</b> )				
4.3pF( <b>4R3</b> )	0.8( <b>B</b> )	1.25( <b>B</b> )			1.50( <b>Q</b> )				
4.7pF( <b>4R7</b> )	0.8( <b>B</b> )	1.25( <b>B</b> )			1.50( <b>Q</b> )				
5.1pF( <b>5R1</b> )	0.8( <b>B</b> )	1.25( <b>B</b> )			1.50( <b>Q</b> )				
5.6pF( <b>5R6</b> )	0.8( <b>B</b> )	1.25( <b>B</b> )			1.50( <b>Q</b> )				
6.2pF( <b>6R2</b> )	0.8( <b>B</b> )	1.25( <b>B</b> )			1.50( <b>Q</b> )				
6.8pF( <b>6R8</b> )	0.8( <b>B</b> )	1.25( <b>B</b> )			1.50( <b>Q</b> )				
7.5pF( <b>7R5</b> )	0.8( <b>B</b> )	1.25( <b>B</b> )			1.50( <b>Q</b> )				
8.2pF( <b>8R2</b> )	0.8( <b>B</b> )	1.25( <b>B</b> )			1.50( <b>Q</b> )				
9.1pF( <b>9R1</b> )	0.8( <b>B</b> )	1.25( <b>B</b> )			1.50( <b>Q</b> )				
10pF( <b>100</b> )	0.8( <b>B</b> )	1.25( <b>B</b> )			1.50( <b>Q</b> )				
11pF( <b>110</b> )	0.8( <b>B</b> )	1.25( <b>B</b> )			1.50( <b>Q</b> )				
12pF( <b>120</b> )	0.8( <b>B</b> )	1.25( <b>B</b> )			1.50( <b>Q</b> )				
13pF( <b>130</b> )	0.8( <b>B</b> )	1.25( <b>B</b> )			1.50( <b>Q</b> )				

Continued on the following page.

Continued from the preceding page.

Part Number	ERB18		ERB21			ERB32			
L x W	1.6x0.8		2.0x1.25			3.2x2.5			
TC	COG (5C)		COG (5C)			COG (5C)			
Rated Volt.	250 (2E)	250 (2E)	100 (2A)	50 (1H)	500 (2H)	300 (YD)	250 (2E)	100 (2A)	50 (1H)
Capacitance (Capacitance part numbering code) and T (mm) Dimension (T Dimension part numbering code)									
15pF(150)	0.8(B)	1.25(B)			1.50(Q)				
16pF(160)	0.8(B)	1.25(B)			1.50(Q)				
18pF(180)	0.8(B)	1.25(B)			1.50(Q)				
20pF(200)	0.8(B)	1.25(B)			1.50(Q)				
22pF(220)	0.8(B)	1.25(B)			1.50(Q)				
24pF(240)	0.8(B)	1.25(B)			1.50(Q)				
27pF(270)	0.8(B)	1.25(B)			1.50(Q)				
30pF(300)	0.8(B)	1.25(B)			1.50(Q)				
33pF(330)	0.8(B)	1.25(B)			1.50(Q)				
36pF(360)	0.8(B)	1.25(B)			1.50(Q)				
39pF(390)	0.8(B)	1.25(B)			1.50(Q)				
43pF(430)	0.8(B)	1.25(B)			1.50(Q)				
47pF(470)	0.8(B)	1.25(B)			1.50(Q)				
51pF(510)	0.8(B)	1.25(B)			1.50(Q)				
56pF(560)	0.8(B)	1.25(B)			1.50(Q)				
62pF(620)	0.8(B)	1.25(B)			1.50(Q)				
68pF(680)	0.8(B)	1.25(B)			1.50(Q)				
75pF(750)	0.8(B)	1.25(B)			1.50(Q)				
82pF(820)	0.8(B)	1.25(B)			1.50(Q)				
91pF(910)	0.8(B)	1.25(B)			1.50(Q)				
100pF(101)	0.8(B)	1.25(B)			1.50(Q)				
120pF(121)			1.25(B)		1.50(Q)				
130pF(131)			1.25(B)			1.50(Q)			
150pF(151)				1.25(B)		1.50(Q)			
160pF(161)				1.25(B)			1.50(Q)		
180pF(181)							1.50(Q)		
200pF(201)							1.50(Q)		
220pF(221)							1.50(Q)		
240pF(241)								1.50(Q)	
270pF(271)								1.50(Q)	
300pF(301)								1.50(Q)	
330pF(331)								1.50(Q)	
360pF(361)								1.50(Q)	
390pF(391)								1.50(Q)	
430pF(431)								1.50(Q)	
470pF(471)								1.50(Q)	
510pF(511)									1.50(Q)
560pF(561)									1.50(Q)
620pF(621)									1.50(Q)
680pF(681)									1.50(Q)
750pF(751)									1.50(Q)
820pF(821)									1.50(Q)
910pF(911)									1.50(Q)
1000pF(102)									1.50(Q)

The part numbering code is shown in ( ).  
 Dimensions are shown in mm and Rated Voltage in Vdc.

14

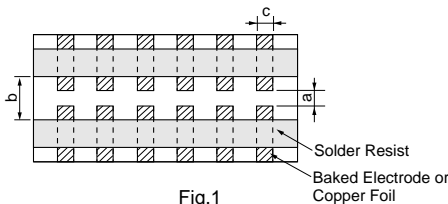

## Specifications and Test Methods

No.	Item	Specifications	Test Method														
1	Operating Temperature Range	-55 to +125°C	Reference Temperature: 25°C														
2	Rated Voltage	See the previous pages.	The rated voltage is defined as the maximum voltage which may be applied continuously to the capacitor. When AC voltage is superimposed on DC voltage, $V^{P-P}$ or $V^{O-P}$ , whichever is larger, should be maintained within the rated voltage range.														
3	Appearance	No defects or abnormalities	Visual inspection														
4	Dimensions	Within the specified dimension	Using calipers														
5	Dielectric Strength	No defects or abnormalities	No failure should be observed when 300%(*) of the rated voltage is applied between the terminations for 1 to 5 seconds, provided the charge/discharge current is less than 50mA. (*) 300V: 250%, 500V: 200%														
6	Insulation Resistance (I.R.)	1,000,000MΩ min. (C≥470pF) 100,000MΩ min. (C>470pF)	The insulation resistance should be measured with a DC voltage not exceeding the rated voltage at 25°C and standard humidity and within 2 minutes of charging.														
7	Capacitance	Within the specified tolerance	The capacitance/Q should be measured at 25°C at the frequency and voltage shown in the table.														
8	Q	$C \leq 220\text{pF} : Q \geq 10,000$ $220\text{pF} < C \leq 470\text{pF} : Q \geq 5,000$ $470\text{pF} < C \leq 1,000\text{pF} : Q \geq 3,000$ C : Nominal Capacitance (pF)	<table border="1" style="margin-left: auto; margin-right: auto;"> <tr> <td>Frequency</td> <td>1±0.1MHz</td> </tr> <tr> <td>Voltage</td> <td>1±0.2Vrms</td> </tr> </table>	Frequency	1±0.1MHz	Voltage	1±0.2Vrms										
Frequency	1±0.1MHz																
Voltage	1±0.2Vrms																
9	Capacitance Temperature Characteristics	Capacitance Change	The temperature coefficient is determined using the capacitance measured in step 3 as a reference. When cycling the temperature sequentially from step 1 through 5, the capacitance should be within the specified tolerance for the temperature coefficient and capacitance change as Table A. The capacitance drift is calculated by dividing the differences between the maximum and minimum measured values in steps 1, 3 and 5 by the capacitance value in step 3.														
		Temperature Coefficient															
		Capacitance Drift		Within ±0.2% or ±0.05pF (Whichever is larger)													
10	Adhesive Strength of Termination	No removal of the terminations or other defects should occur.	Solder the capacitor on the test jig (glass epoxy board) shown in Fig. 1 using an eutectic solder. Then apply 10N* force in parallel with the test jig for 10±1sec. The soldering should be done either with an iron or using the reflow method and should be conducted with care so that the soldering is uniform and free of defects such as heat shock.														
				<table border="1" style="margin-left: auto; margin-right: auto;"> <thead> <tr> <th>Type</th> <th>a</th> <th>b</th> <th>c</th> </tr> </thead> <tbody> <tr> <td><b>ERB18</b></td> <td>1.0</td> <td>3.0</td> <td>1.2</td> </tr> <tr> <td><b>ERB21</b></td> <td>1.2</td> <td>4.0</td> <td>1.65</td> </tr> <tr> <td><b>ERB32</b></td> <td>2.2</td> <td>5.0</td> <td>2.9</td> </tr> </tbody> </table> <p style="text-align: right;">(in mm) *5N (ERB188)</p>	Type	a	b	c	<b>ERB18</b>	1.0	3.0	1.2	<b>ERB21</b>	1.2	4.0	1.65	<b>ERB32</b>
Type	a	b	c														
<b>ERB18</b>	1.0	3.0	1.2														
<b>ERB21</b>	1.2	4.0	1.65														
<b>ERB32</b>	2.2	5.0	2.9														

Continued on the following page.

# Specifications and Test Methods

Continued from the preceding page.

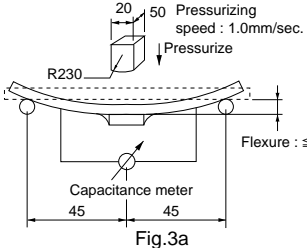
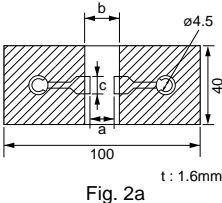
No.	Item	Specifications	Test Method									
11	Appearance	No defects or abnormalities	Solder the capacitor to the test jig (glass epoxy board) in the same manner and under the same conditions as (10). The capacitor should be subjected to a simple harmonic motion having a total amplitude of 1.5mm, the frequency being varied uniformly between the approximate limits of 10 and 55Hz. The frequency range, from 10 to 55Hz and return to 10Hz, should be traversed in approximately 1 minute. This motion should be applied for a period of 2 hours in each 3 mutually perpendicular directions (total of 6 hours).									
	Capacitance	Within the specified tolerance										
	Q	Satisfies the initial value. $C \leq 220\text{pF} : Q \geq 10,000$ $220\text{pF} < C \leq 470\text{pF} : Q \geq 5,000$ $470\text{pF} < C \leq 1,000\text{pF} : Q \geq 3,000$ C : Nominal Capacitance (pF)										
12	Deflection	No crack or marked defect should occur.	Solder the capacitor on the test jig (glass epoxy board) shown in Fig. 2a using an eutectic solder. Then apply a force in the direction shown in Fig. 3a. The soldering should be done either with an iron or using the reflow method and should be conducted with care so that the soldering is uniform and free of defects such as heat shock.									
		 										
13	Solderability of Termination	95% of the terminations are to be soldered evenly and continuously.	Immerse the capacitor in a solution of isopropyl alcohol and rosin (25% rosin in weight proportion). Preheat at 80 to 120°C for 10 to 30 seconds. After preheating, immerse in an eutectic solder or Sn-3.0Ag-0.5Cu solder solution for 5±0.5 seconds at 245±5°C.									
14	Resistance to Soldering Heat	The measured and observed characteristics should satisfy the specifications in the following table.	Preheat according to the conditions listed in the table below. Immerse the capacitor in an eutectic solder or Sn-3.0Ag-0.5Cu solder solution at 270±5°C for 10±0.5 seconds. Let sit at room temperature for 24±2 hours.									
		<table border="1"> <thead> <tr> <th>Item</th> <th>Specifications</th> </tr> </thead> <tbody> <tr> <td>Appearance</td> <td>No marked defect</td> </tr> <tr> <td>Capacitance Change</td> <td>Within ±2.5% or ±0.25pF (Whichever is larger)</td> </tr> <tr> <td>Q</td> <td><math>C \leq 220\text{pF} : Q \geq 10,000</math>  <math>220\text{pF} &lt; C \leq 470\text{pF} : Q \geq 5,000</math>  <math>470\text{pF} &lt; C \leq 1,000\text{pF} : Q \geq 3,000</math></td> </tr> <tr> <td>Dielectric Strength</td> <td>No failure</td> </tr> </tbody> </table> <p>C : Nominal Capacitance (pF)</p>		Item	Specifications	Appearance	No marked defect	Capacitance Change	Within ±2.5% or ±0.25pF (Whichever is larger)	Q	$C \leq 220\text{pF} : Q \geq 10,000$ $220\text{pF} < C \leq 470\text{pF} : Q \geq 5,000$ $470\text{pF} < C \leq 1,000\text{pF} : Q \geq 3,000$	Dielectric Strength
Item	Specifications											
Appearance	No marked defect											
Capacitance Change	Within ±2.5% or ±0.25pF (Whichever is larger)											
Q	$C \leq 220\text{pF} : Q \geq 10,000$ $220\text{pF} < C \leq 470\text{pF} : Q \geq 5,000$ $470\text{pF} < C \leq 1,000\text{pF} : Q \geq 3,000$											
Dielectric Strength	No failure											
15	Temperature Cycle	The measured and observed characteristics should satisfy the specifications in the following table.	Fix the capacitor to the supporting jig in the same manner and under the same conditions as (10). Perform the five cycles according to the four heat treatments listed in the following table. Let sit for 24±2 hours at room temperature, then measure.									
		<table border="1"> <thead> <tr> <th>Item</th> <th>Specifications</th> </tr> </thead> <tbody> <tr> <td>Appearance</td> <td>No marked defect</td> </tr> <tr> <td>Capacitance Change</td> <td>Within ±5% or ±0.5pF (Whichever is larger)</td> </tr> <tr> <td>Q</td> <td><math>C \geq 30\text{pF} : Q \geq 350</math>  <math>10\text{pF} \leq C &lt; 30\text{pF} : Q \geq 275 + \frac{C}{10}</math>  <math>C &lt; 10\text{pF} : Q \geq 200 + 10C</math></td> </tr> <tr> <td>I.R.</td> <td>1,000MΩ min.</td> </tr> <tr> <td>Dielectric Strength</td> <td>No failure</td> </tr> </tbody> </table> <p>C : Nominal Capacitance (pF)</p>		Item	Specifications	Appearance	No marked defect	Capacitance Change	Within ±5% or ±0.5pF (Whichever is larger)	Q	$C \geq 30\text{pF} : Q \geq 350$ $10\text{pF} \leq C < 30\text{pF} : Q \geq 275 + \frac{C}{10}$ $C < 10\text{pF} : Q \geq 200 + 10C$	I.R.
Item	Specifications											
Appearance	No marked defect											
Capacitance Change	Within ±5% or ±0.5pF (Whichever is larger)											
Q	$C \geq 30\text{pF} : Q \geq 350$ $10\text{pF} \leq C < 30\text{pF} : Q \geq 275 + \frac{C}{10}$ $C < 10\text{pF} : Q \geq 200 + 10C$											
I.R.	1,000MΩ min.											
Dielectric Strength	No failure											
16	Humidity	The measured and observed characteristics should satisfy the specifications in the following table.	Apply the 24-hour heat (-10 to +65°C) and humidity (80 to 100%) treatment shown below, 10 consecutive times. Remove, let sit for 24±2 hours at room temperature, and measure.									
		<table border="1"> <thead> <tr> <th>Item</th> <th>Specifications</th> </tr> </thead> <tbody> <tr> <td>Appearance</td> <td>No marked defect</td> </tr> <tr> <td>Capacitance Change</td> <td>Within ±5% or ±0.5pF (Whichever is larger)</td> </tr> <tr> <td>Q</td> <td><math>C \geq 30\text{pF} : Q \geq 350</math>  <math>10\text{pF} \leq C &lt; 30\text{pF} : Q \geq 275 + \frac{C}{10}</math>  <math>C &lt; 10\text{pF} : Q \geq 200 + 10C</math></td> </tr> <tr> <td>I.R.</td> <td>1,000MΩ min.</td> </tr> </tbody> </table> <p>C : Nominal Capacitance (pF)</p>		Item	Specifications	Appearance	No marked defect	Capacitance Change	Within ±5% or ±0.5pF (Whichever is larger)	Q	$C \geq 30\text{pF} : Q \geq 350$ $10\text{pF} \leq C < 30\text{pF} : Q \geq 275 + \frac{C}{10}$ $C < 10\text{pF} : Q \geq 200 + 10C$	I.R.
Item	Specifications											
Appearance	No marked defect											
Capacitance Change	Within ±5% or ±0.5pF (Whichever is larger)											
Q	$C \geq 30\text{pF} : Q \geq 350$ $10\text{pF} \leq C < 30\text{pF} : Q \geq 275 + \frac{C}{10}$ $C < 10\text{pF} : Q \geq 200 + 10C$											
I.R.	1,000MΩ min.											

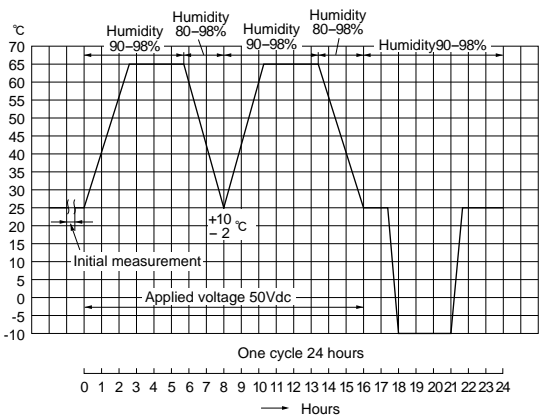

Continued on the following page. ↗

## Specifications and Test Methods

Continued from the preceding page.

No.	Item	Specifications	Test Method												
17	High Temperature Load	<p>The measured and observed characteristics should satisfy the specifications in the following table.</p> <table border="1" style="width: 100%; border-collapse: collapse; margin-bottom: 10px;"> <thead> <tr> <th style="width: 30%;">Item</th> <th style="width: 70%;">Specifications</th> </tr> </thead> <tbody> <tr> <td>Appearance</td> <td>No marked defect</td> </tr> <tr> <td>Capacitance Change</td> <td>Within <math>\pm 3\%</math> or <math>\pm 0.3\text{pF}</math> (Whichever is larger)</td> </tr> <tr> <td>Q</td> <td><math>C \geq 30\text{pF} : Q \geq 350</math> <math>10\text{pF} \leq C &lt; 30\text{pF} : Q \geq 275 + \frac{5}{2} C</math> <math>C &lt; 10\text{pF} : Q \geq 200 + 10C</math></td> </tr> <tr> <td>I.R.</td> <td>1,000M<math>\Omega</math> min.</td> </tr> <tr> <td>Dielectric Strength</td> <td>No failure</td> </tr> </tbody> </table> <p style="text-align: right; margin-right: 50px;">C : Nominal Capacitance (pF)</p>	Item	Specifications	Appearance	No marked defect	Capacitance Change	Within $\pm 3\%$ or $\pm 0.3\text{pF}$ (Whichever is larger)	Q	$C \geq 30\text{pF} : Q \geq 350$ $10\text{pF} \leq C < 30\text{pF} : Q \geq 275 + \frac{5}{2} C$ $C < 10\text{pF} : Q \geq 200 + 10C$	I.R.	1,000M $\Omega$ min.	Dielectric Strength	No failure	<p>Apply 200% (500V only 150%) of the rated voltage for 1,000<math>\pm</math>12 hours at 125<math>\pm</math>3<math>^{\circ}</math>C. Remove and let sit for 24<math>\pm</math>2 hours at room temperature, then measure.                      The charge/discharge current is less than 50mA.</p>
Item	Specifications														
Appearance	No marked defect														
Capacitance Change	Within $\pm 3\%$ or $\pm 0.3\text{pF}$ (Whichever is larger)														
Q	$C \geq 30\text{pF} : Q \geq 350$ $10\text{pF} \leq C < 30\text{pF} : Q \geq 275 + \frac{5}{2} C$ $C < 10\text{pF} : Q \geq 200 + 10C$														
I.R.	1,000M $\Omega$ min.														
Dielectric Strength	No failure														

Table A-6

Char.	Nominal Values (ppm/ $^{\circ}$ C) Note 1	Capacitance Change from 25 $^{\circ}$ C (%)					
		-55		-30		-10	
		Max.	Min.	Max.	Min.	Max.	Min.
5C	0 $\pm$ 30	0.58	-0.24	0.40	-0.17	0.25	-0.11

Note 1 : Nominal values denote the temperature coefficient within a range of 25 to 125 $^{\circ}$ C (for 5C)

# ERB Series Data

## Q-Frequency Characteristics

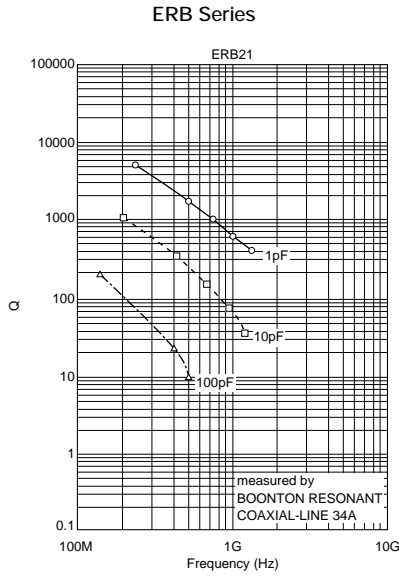

## Impedance-Frequency Characteristics

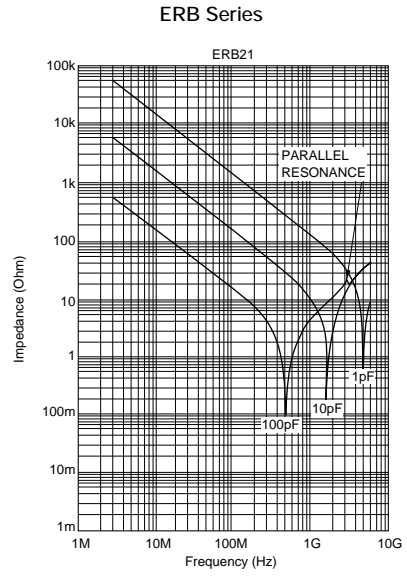

## ESR-Frequency Characteristics

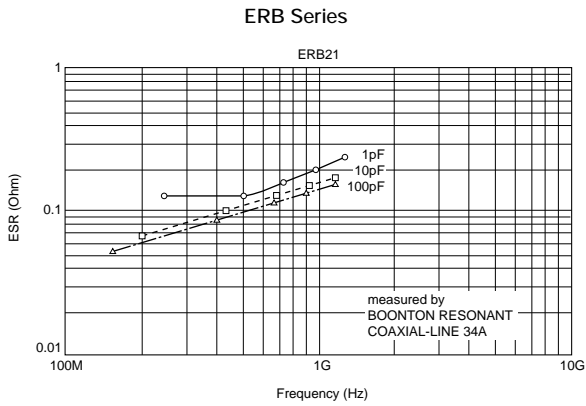

## Resonant Frequency-Capacitance

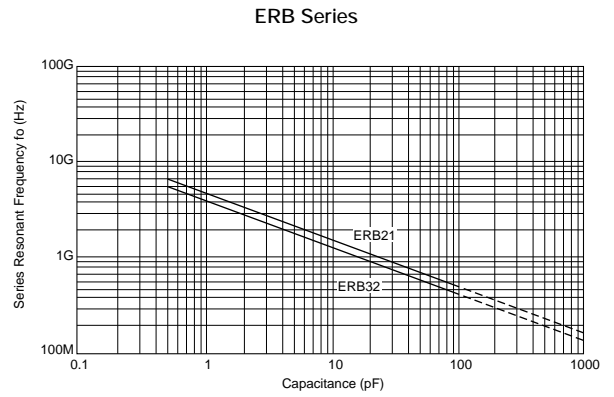

## Allowable Voltage-Frequency

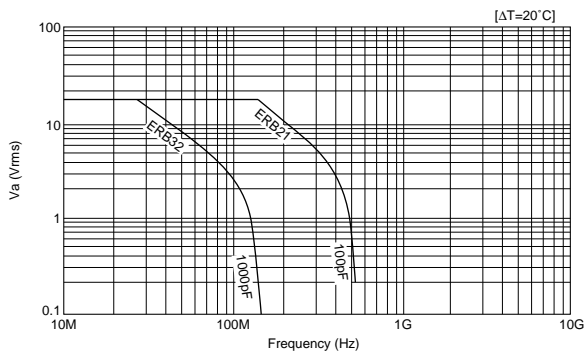

## Allowable Current-Frequency

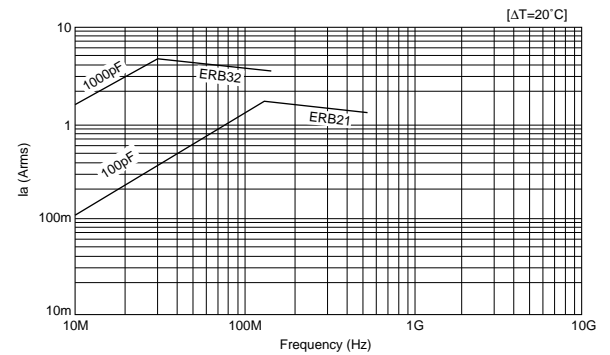

Continued on the following page.

## ERB Series Data

Continued from the preceding page.

### ■ Allowable Apparent Power-Frequency

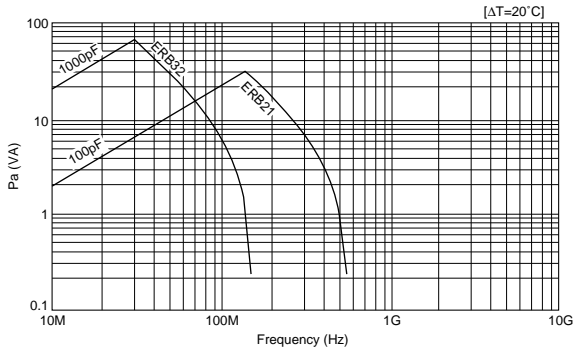

### ■ Allowable Effective Power-Frequency

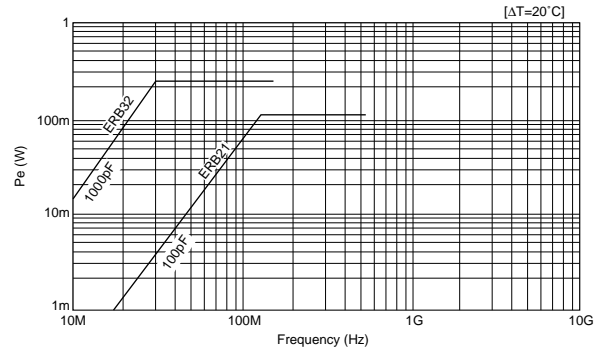

## Package

### ■ Packaging Code

Packaging Type	Tape Carrier Packaging	Bulk Case Packaging	Bulk Packaging	
			Bulk Packaging in a Bag	Bulk Packaging in a Tray
Packaging Code	D, L, K, J	C	B	T

### ■ Minimum Quantity Guide

Part Number	Dimensions (mm)			Quantity (pcs.)							
				ø180mm reel		ø330mm reel		Bulk Case	Bulk Bag		
	L	W	T	Paper Tape	Embossed Tape	Paper Tape	Embossed Tape				
Ultra Miniaturized	<b>GRM02</b>	0.4	0.2	0.2	20,000	-	-	-	-	-	
	<b>GRM03</b>	0.6	0.3	0.3	15,000	-	50,000	-	-	1,000	
For Flow/Reflow	<b>GRM18</b>	1.6	0.8	0.8	4,000	-	10,000	-	15,000	1,000	
				0.6	4,000	-	10,000	-	10,000	1,000	
	<b>GRM21</b>	2.0	1.25	0.85/1.0	4,000	-	10,000	-	-	1,000	
				1.25	-	3,000	-	10,000	5,000 <sup>2)</sup>	1,000	
	<b>GRM31</b>	3.2	1.6	0.6/0.85	4,000	-	10,000	-	-	1,000	
				1.15	-	3,000	-	10,000	-	1,000	
			1.6	-	2,000	-	6,000	-	1,000		
For Reflow	<b>GRM15X</b>	1.0	0.5	0.25	10,000	-	50,000	-	-	1,000	
	<b>GRM155</b>	1.0	0.5	0.5	10,000	-	50,000	-	50,000	1,000	
	<b>GRM32</b>	3.2	2.5	0.85	-	4,000	-	10,000	-	-	1,000
				1.15	-	3,000	-	10,000	-	-	1,000
				1.35	-	2,000	-	8,000	-	-	1,000
				1.6	-	2,000	-	6,000	-	-	1,000
	<b>GRM43</b>	4.5	3.2	1.8/2.0	-	1,000	-	4,000	-	-	1,000
				2.5	-	1,000	-	5,000	-	-	1,000
				1.35/1.6	-	1,000	-	4,000	-	-	1,000
				1.8/2.0	-	500	-	2,000	-	-	1,000
	<b>GRM55</b>	5.7	5.0	2.8	-	500	-	1,500	-	-	1,000
				1.15	-	1,000	-	5,000	-	-	1,000
				1.35/1.6	-	1,000	-	4,000	-	-	1,000
				2.5	-	500	-	2,000	-	-	500
			3.2	-	300	-	1,500	-	500		
High Power Type	<b>GJM03</b>	0.6	0.3	0.3	15,000	-	50,000	-	-	1,000	
	<b>GJM15</b>	1.0	0.5	0.5	10,000	-	50,000	-	50,000	1,000	
High Frequency	<b>QQM18</b>	1.6	0.8	0.8	4,000	-	10,000	-	-	1,000	
	<b>QQM21</b>	2.0	1.25	0.85	4,000	-	10,000	-	-	1,000	
	<b>ERB18</b>	1.6	0.8	0.9 max.	4,000	-	10,000	-	-	1,000	
	<b>ERB21</b>	2.0	1.25	1.35 max.	-	3,000	-	10,000	-	1,000	
	<b>ERB32</b>	3.2	2.5	1.7 max.	-	2,000	-	8,000	-	1,000	
For Ultrasonic	<b>GRM21</b>	2.0	1.25	0.85	4,000	-	10,000	-	-	1,000	
Micro Chip	<b>GMA05</b>	0.5	0.5	0.35	-	-	-	-	-	400 <sup>1)</sup>	
	<b>GMA08</b>	0.8	0.8	0.5	-	-	-	-	-	400 <sup>1)</sup>	
Array	<b>GNM1M</b>	1.37	1.0	0.6	4,000	-	10,000	-	-	1,000	
	<b>GNM31</b>	3.2	1.6	0.8	4,000	-	10,000	-	-	1,000	
				1.0	-	3,000	-	10,000	-	1,000	
	<b>GNM21</b>	2.0	1.25	0.6/0.85	4,000	-	10,000	-	-	1,000	
Low ESL	<b>LLL18</b>	0.8	1.6	0.5	-	4,000	-	10,000	-	1,000	
				0.5/0.6	-	4,000	-	10,000	-	1,000	
	<b>LLL21</b>	1.25	2.0	0.85	-	3,000	-	10,000	-	1,000	
				0.5/0.7	-	4,000	-	10,000	-	1,000	
	<b>LLL31</b>	1.6	3.2	1.15	-	3,000	-	10,000	-	1,000	
				0.5	-	4,000	-	10,000	-	1,000	
	<b>LLA18</b>	1.6	0.8	0.5	-	4,000	-	10,000	-	1,000	
				0.5	-	4,000	-	10,000	-	1,000	
	<b>LLA21</b>	2.0	1.25	0.85	-	3,000	-	10,000	-	1,000	
				0.5	-	4,000	-	10,000	-	1,000	
	<b>LLA31</b>	3.2	1.6	0.85	-	3,000	-	10,000	-	1,000	
				1.15	-	3,000	-	10,000	-	1,000	
0.5				-	4,000	-	10,000	-	1,000		
<b>LLM21</b>	2.0	1.25	0.85	-	3,000	-	10,000	-	1,000		
			0.5	-	4,000	-	10,000	-	1,000		
<b>LLM31</b>	3.2	1.6	0.5	-	4,000	-	10,000	-	1,000		
			1.15	-	3,000	-	10,000	-	1,000		

1) Tray 2) 10µF, 1.0µF, 3.3/4.7µF of 6.3V R6 rated are not available by bulk case.

Continued on the following page. 

## Package

Continued from the preceding page.

### ■ Tape Carrier Packaging

#### (1) Dimensions of Reel

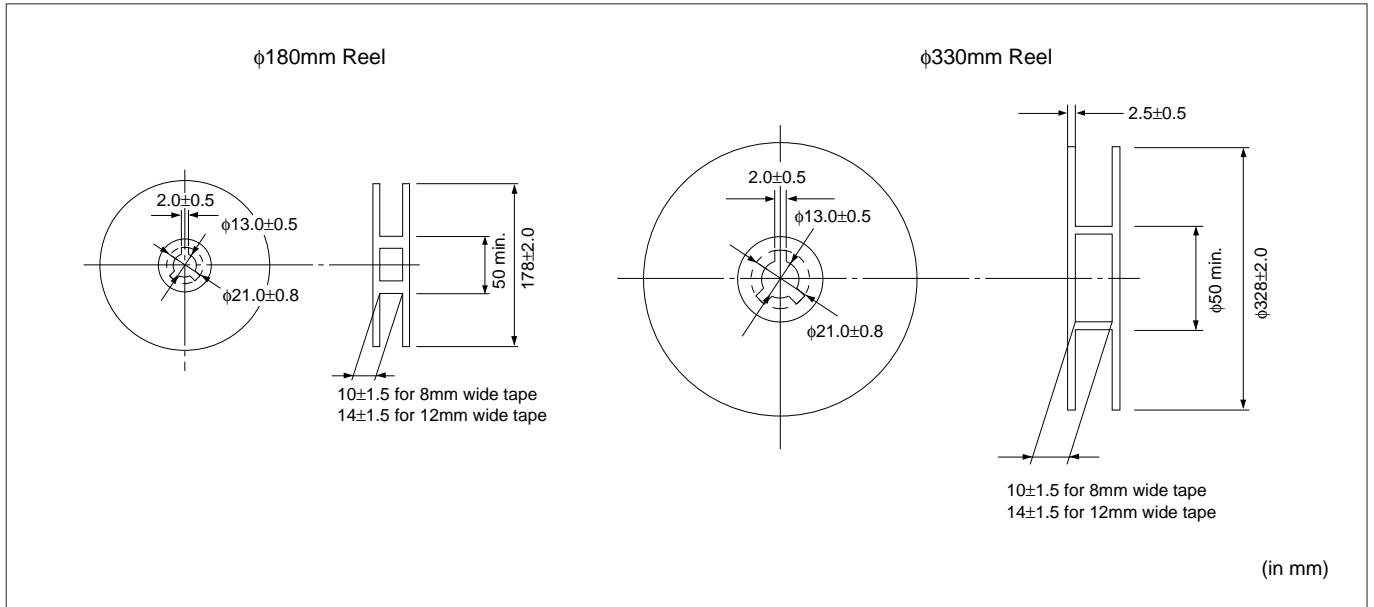

#### (2) Dimensions of Paper Tape

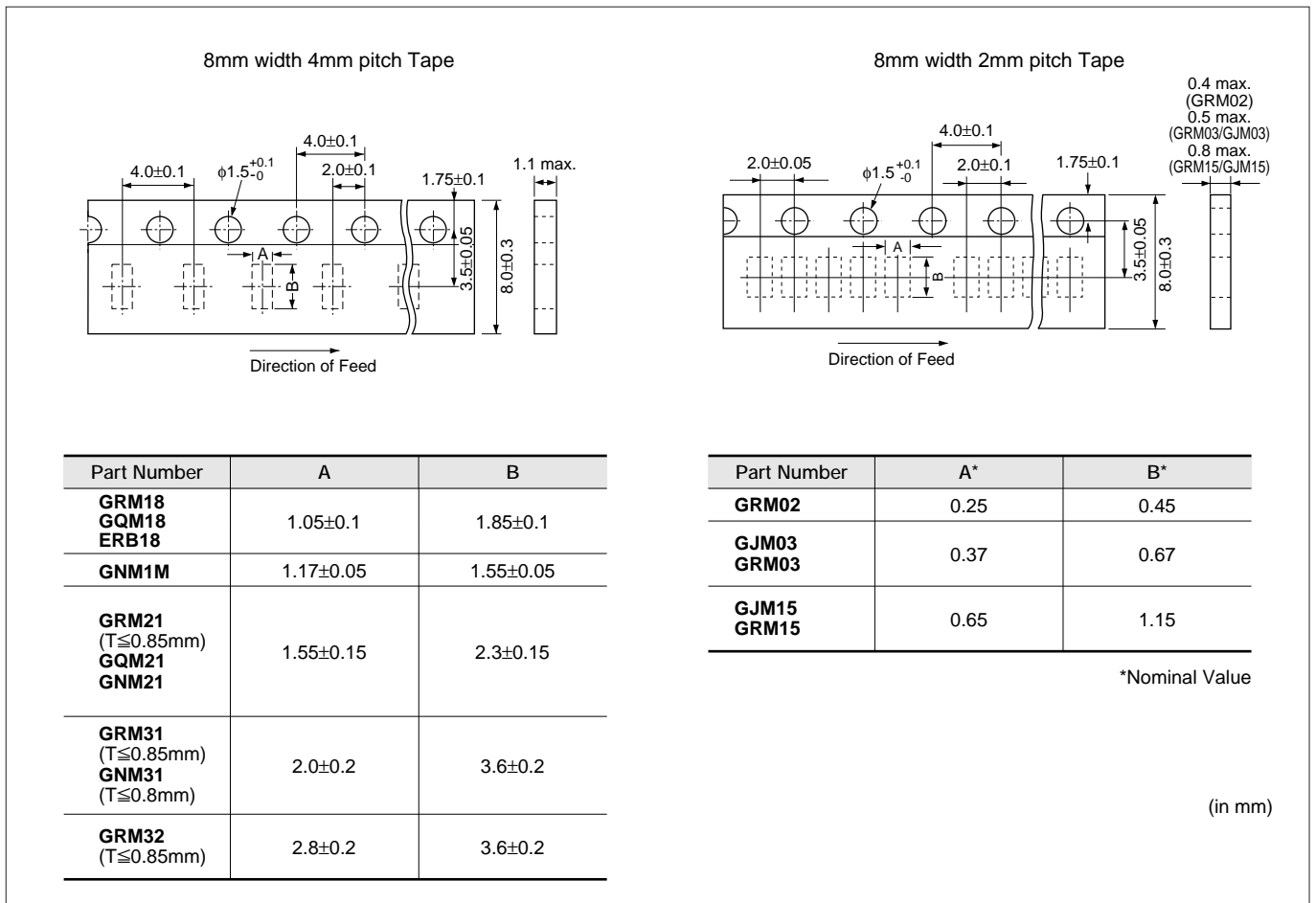

Continued on the following page. ↗

## Package

Continued from the preceding page.

### (3) Dimensions of Embossed Tape

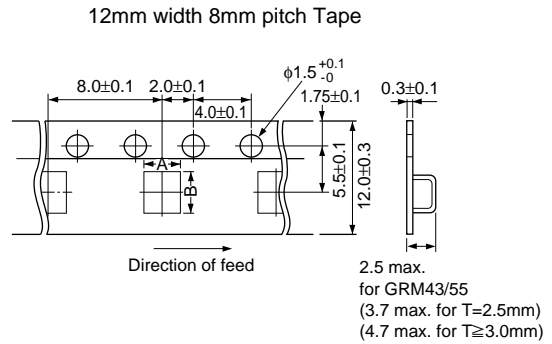
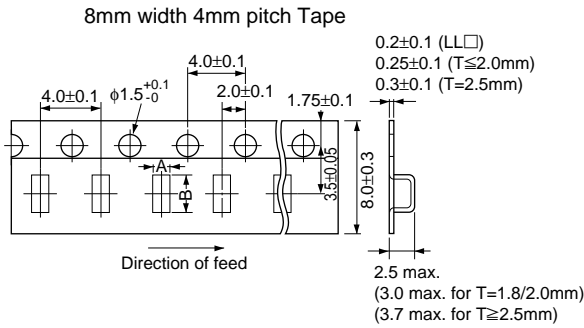

Part Number	A	B
<b>LLL18, LLA18</b>	1.05±0.1	1.85±0.1
<b>GRM21, ERB21</b> (T≥1.0mm) <b>LLL21</b> <b>LLA21, LLM21</b>	1.45±0.2	2.25±0.2
<b>GRM31</b> (T≥1.15mm) <b>LLL31</b> <b>LLA31, LLM31</b> <b>GJM31</b> (T≥1.0mm)	1.9±0.2	3.5±0.2
<b>GRM32, ERB32</b> (T≥1.15mm)	2.8±0.2	3.5±0.2

Part Number	A*	B*
<b>GRM43</b>	3.6	4.9
<b>GRM55</b>	5.2	6.1

\*Nominal Value

\*Nominal Value

(in mm)

### (4) Taping Method

- Tapes for capacitors are wound clockwise. The sprocket holes are to the right as the tape is pulled toward the user.
- Part of the leader and part of the empty tape should be attached to the end of the tape as follows.
- The top tape and base tape are not attached at the end of the tape for a minimum of 5 pitches.
- Missing capacitors number within 0.1% of the number per reel or 1 pc, whichever is greater, and are not continuous.
- The top tape and bottom tape should not protrude beyond the edges of the tape and should not cover sprocket holes.
- Cumulative tolerance of sprocket holes, 10 pitches: ±0.3mm.
- Peeling off force: 0.1 to 0.6N\* in the direction shown below.

\*GRM02  
GRM03 } : 0.05 to 0.5N  
GJM03 }

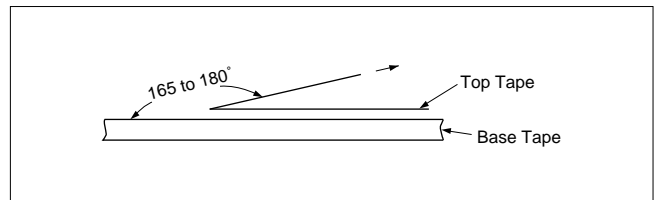
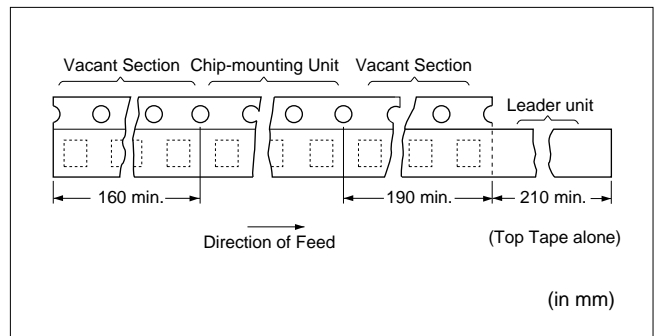

Continued on the following page. ↗



## Package

☐ Continued from the preceding page.

### ■ Dimensions of Bulk Case Packaging

The bulk case uses antistatic materials. Please contact Murata for details.

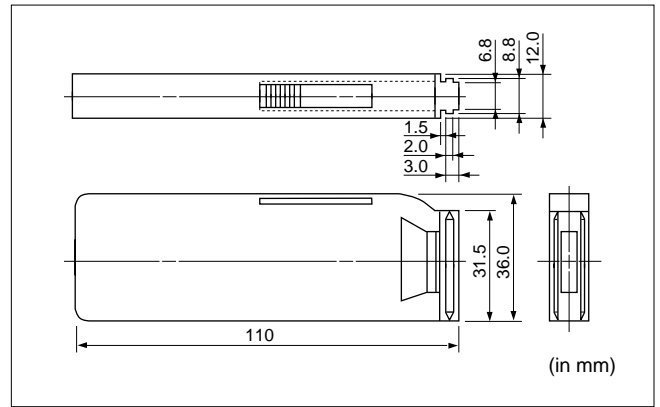

## ⚠ Caution

### ■ Storage and Operating Conditions

Chip monolithic ceramic capacitors (chips) can experience degradation of termination solderability when subjected to high temperature or humidity, or if exposed to sulfur or chlorine gases.

Storage environment must be at an ambient temperature of 5-40 degree C and an ambient humidity of 20-70%RH.

Use chip within 6 months. If 6 months or more have elapsed, check solderability before use.

FAILURE TO FOLLOW THE ABOVE CAUTIONS MAY RESULT, WORST CASE, IN A SHORT CIRCUIT AND CAUSE FUMING OR PARTIAL DISPERSION WHEN THE PRODUCT IS USED.

### ■ Handling

#### 1. Inspection

Thrusting force of the test probe can flex the PCB, resulting in cracked chips or open solder joints.

Provide support pins on the back side of the PCB to prevent warping or flexing.

#### 2. Board Separation (or depanelization)

(1) Board flexing at the time of separation causes cracked chips or broken solder.

(2) Severity of stresses imposed on the chip at the time of board break is in the order of:  
Pushback<Slitter<V Slot<Perforator.

(3) Board separation must be performed using special jigs, not with hands.

#### 3. Reel and bulk case

In the handling of reel and case, please be careful and do not drop it.

Do not use chips from a case which has been dropped.

FAILURE TO FOLLOW THE ABOVE CAUTIONS MAY RESULT, WORST CASE, IN A SHORT CIRCUIT AND FUMING WHEN THE PRODUCTS IS USED.

**Caution**

**■ Soldering and Mounting**

**1. Mounting Position**

Choose a mounting position that minimizes the stress imposed on the chip during flexing or bending of the board.

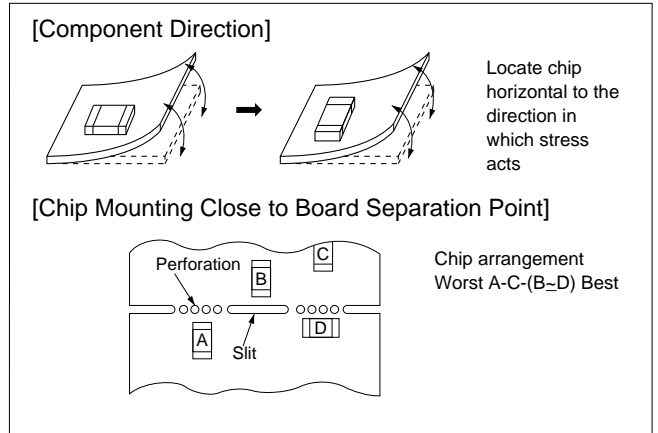

(Reference Data 2. Board bending strength for solder fillet height)  
 (Reference Data 3. Temperature cycling for solder fillet height)  
 (Reference Data 4. Board bending strength for board material)

**2. Solder Paste Printing**

- Overly thick application of solder paste results in excessive fillet height solder. This makes the chip more susceptible to mechanical and thermal stress on the board and may cause cracked chips.
- Too little solder paste results in a lack of adhesive strength on the outer electrode, which may result in chips breaking loose from the PCB.
- Make sure the solder has been applied smoothly to the end surface to a height of 0.2mm min.

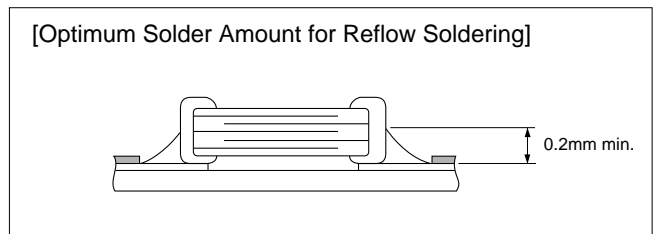

**3. Chip Placing**

- An excessively low bottom dead point of the suction nozzle imposes great force on the chip during mounting, causing cracked chips. So adjust the suction nozzle's bottom dead point by correcting warp in the board. Normally, the suction nozzle's bottom dead point must be set on the upper surface of the board. Nozzle pressure for chip mounting must be a 1 to 3N static load.
  - Dirt particles and dust accumulated between the suction nozzle and the cylinder inner wall prevent the nozzle from moving smoothly. This imposes great force on the chip during mounting, causing cracked chips. And the locating claw, when worn out, imposes uneven forces on the chip when positioning, causing cracked chips. The suction nozzle and the locating claw must be maintained, checked and replaced periodically.
- (Reference Data 5. Break strength)

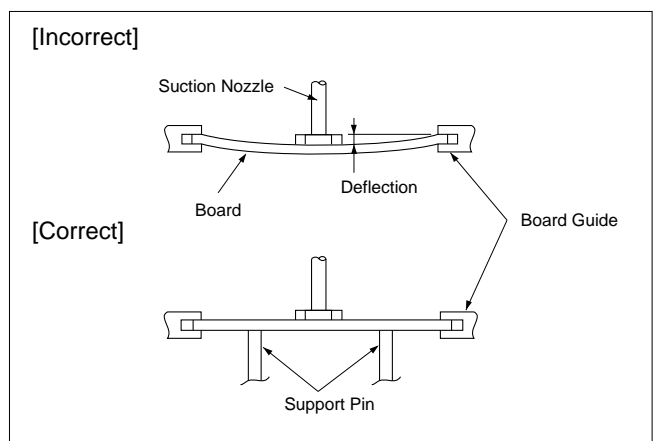

Continued on the following page. ↗

## ⚠ Caution

☐ Continued from the preceding page.

### 4. Reflow Soldering

- Sudden heating of the chip results in distortion due to excessive expansion and construction forces within the chip causing cracked chips. So when preheating, keep temperature differential,  $\Delta T$ , within the range shown in Table 1. The smaller the  $\Delta T$ , the less stress on the chip.
- Solderability of Tin plating termination chip might be deteriorated when low temperature soldering profile where peak solder temperature is below the Tin melting point is used. Please confirm the solderability of Tin plating termination chip before use.
- When components are immersed in solvent after mounting, be sure to maintain the temperature difference ( $\Delta T$ ) between the component and solvent within the range shown in the above table.

Table 1

Part Number	Temperature Differential
GRM02/03/15/18/21/31 GJM03/15 LLL18/21/31 ERB18/21 GQM18/21	$\Delta T \leq 190^\circ\text{C}$
GRM32/43/55 LLA18/21/31 LLM21/31 GNM ERB32	$\Delta T \leq 130^\circ\text{C}$

#### Recommended Conditions

	Pb-Sn Solder		Lead Free Solder
	Infrared Reflow	Vapor Reflow	
Peak Temperature	230-250°C	230-240°C	240-260°C
Atmosphere	Air	Air	Air or N <sub>2</sub>

Pb-Sn Solder: Sn-37Pb

Lead Free Solder: Sn-3.0Ag-0.5Cu

#### Inverting the PCB

Make sure not to impose an abnormal mechanical shock on the PCB.

### 5. Leaded Component Insertion

If the PCB is flexed when leaded components (such as transformers and ICs) are being mounted, chips may crack and solder joints may break.

Before mounting leaded components, support the PCB using backup pins or special jigs to prevent warping.

#### [Standard Conditions for Reflow Soldering]

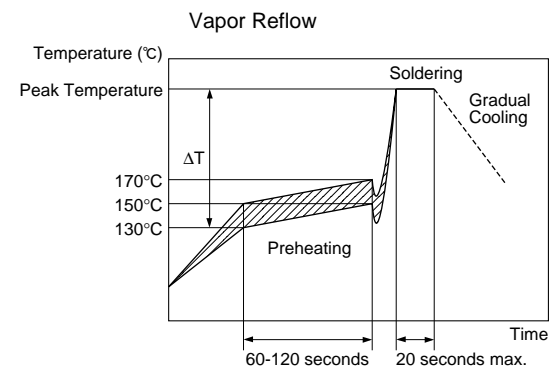
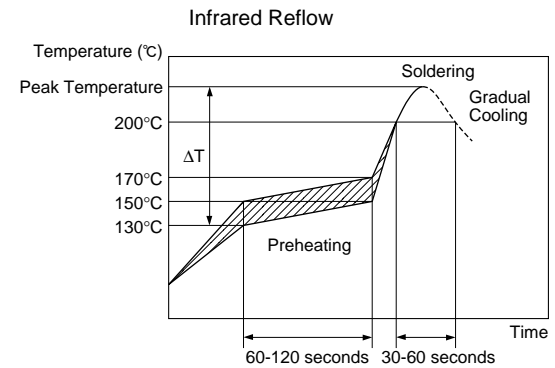

#### [Allowable Soldering Temperature and Time]

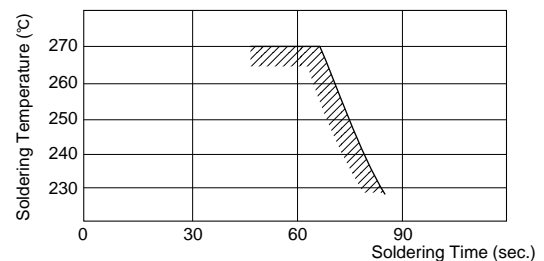

In case of repeated soldering, the accumulated soldering time must be within the range shown above.

Continued on the following page. ☐



Continued from the preceding page.

## 6. Flow Soldering

- Sudden heating of the chip results in thermal distortion causing cracked chips. And an excessively long soldering time or high soldering temperature results in leaching of the outer electrodes, causing poor adhesion or a reduction in capacitance value due to loss of contact between electrodes and end termination.
- When preheating, keep the temperature differential between solder temperature and chip surface temperature,  $\Delta T$ , within the range shown in Table 2. The smaller the  $\Delta T$ , the less stress on the chip. When components are immersed in solvent after mounting, be sure to maintain the temperature difference between the component and solvent within the range shown in Table 2. Do not apply flow soldering to chips not listed in Table 2.

Table 2

Part Number	Temperature Differential
GRM18/21/31 LLL21/31 ERB18/21 GQM18/21	$\Delta T \leq 150^\circ\text{C}$

### Recommended Conditions

	Pb-Sn Solder	Lead Free Solder
Peak Temperature	240-250°C	250-260°C
Atmosphere	Air	N <sub>2</sub>

Pb-Sn Solder: Sn-37Pb  
 Lead Free Solder: Sn-3.0Ag-0.5Cu

- Optimum Solder Amount for Flow Soldering

### [Standard Conditions for Flow Soldering]

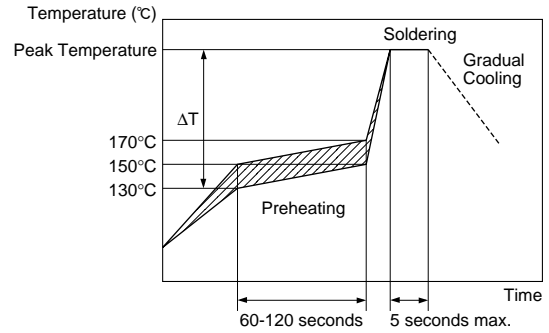

### [Allowable Soldering Temperature and Time]

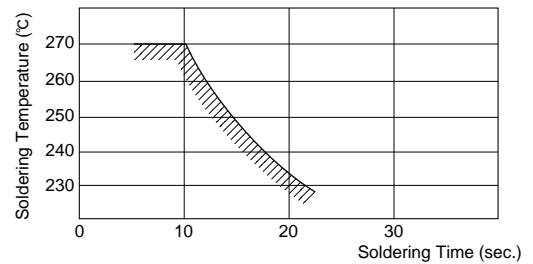

In case of repeated soldering, the accumulated soldering time must be within the range shown above.

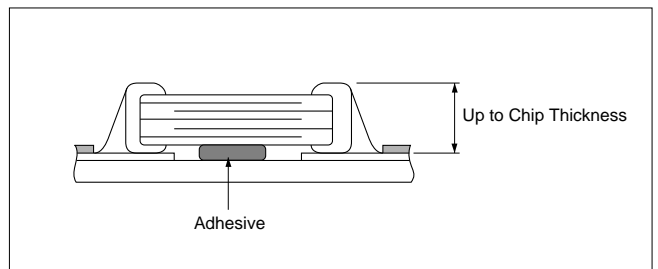

Continued on the following page. ↗

## ⚠ Caution

☐ Continued from the preceding page.

### 7. Correction with a Soldering Iron

(1) For Chip Type Capacitors

- Sudden heating of the chip results in distortion due to a high internal temperature differential, causing cracked chips. When preheating, keep temperature differential,  $\Delta T$ , within the range shown in Table 3. The smaller the  $\Delta T$ , the less stress on the chip.

Table 3

Part Number	Temperature Differential	Peak Temperature	Atmosphere
GRM15/18/21/31 GJM15 LLL18/21/31 GQM18/21 ERB18/21	$\Delta T \leq 190^\circ\text{C}$	300°C max. 3 seconds max. / termination	Air
GRM32/43/55 GNM LLA18/21/31 LLM21/31 ERB32	$\Delta T \leq 130^\circ\text{C}$	270°C max. 3 seconds max. / termination	Air

\*Applicable for both Pb-Sn and Lead Free Solder.

Pb-Sn Solder: Sn-37Pb

Lead Free Solder: Sn-3.0Ag-0.5Cu

- Optimum Solder Amount when Corrections Are Made Using a Soldering Iron

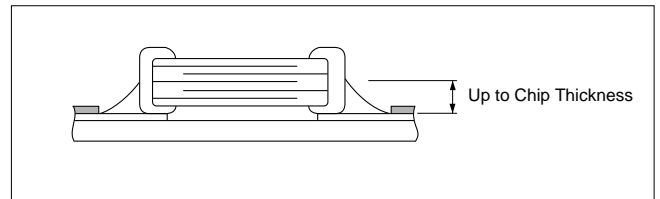
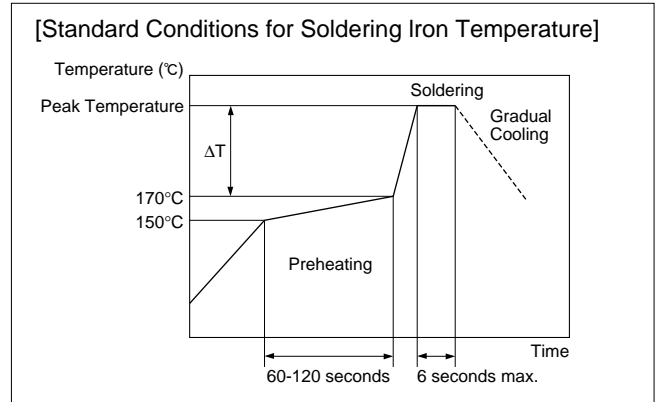

(2) For Microstrip Types

- Solder 1mm away from the ribbon terminal base, being careful that the solder tip does not directly contact the capacitor. Preheating is unnecessary.
- Complete soldering within 3 seconds with a soldering tip less than 270°C in temperature.

### 8. Washing

Excessive output of ultrasonic oscillation during cleaning causes PCBs to resonate, resulting in cracked chips or broken solder. Take note not to vibrate PCBs.

FAILURE TO FOLLOW THE ABOVE CAUTIONS MAY RESULT, WORST CASE, IN A SHORT CIRCUIT AND FUMING WHEN THE PRODUCT IS USED.

## Notice

### ■ Rating

#### Die Bonding/Wire Bonding (GMA Series)

##### 1. Die Bonding of Capacitors

- Use the following materials Braze alloy:  
Au-Sn (80/20) 300 to 320 degree C in N<sub>2</sub> atmosphere
- Mounting
  - (1) Control the temperature of the substrate so that it matches the temperature of the braze alloy.
  - (2) Place braze alloy on substrate and place the capacitor on the alloy. Hold the capacitor and gently apply the load. Be sure to complete the operation in 1 minute.

##### 2. Wire Bonding

- Wire
  - Gold wire:  
20 micro m (0.0008 inch), 25 micro m (0.001 inch) diameter
- Bonding
  - (1) Thermocompression, ultrasonic ball bonding.
  - (2) Required stage temperature : 200 to 250 degree C
  - (3) Required wedge or capillary weight : 0.5N to 2N.
  - (4) Bond the capacitor and base substrate or other devices with gold wire.

## Notice

### ■ Soldering and Mounting

#### 1. PCB Design

##### (1) Notice for Pattern Forms

Unlike leaded components, chip components are susceptible to flexing stresses since they are mounted directly on the substrate.

They are also more sensitive to mechanical and thermal stresses than leaded components.

Excess solder fillet height can multiply these stresses and cause chip cracking. When designing substrates, take land patterns and dimensions into consideration to eliminate the possibility of excess solder fillet height.

#### Pattern Forms

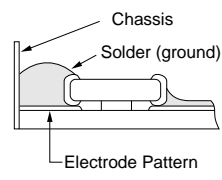
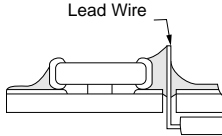
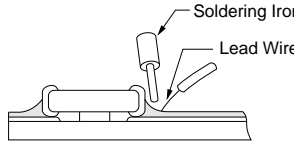
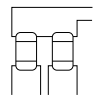
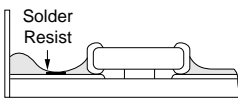
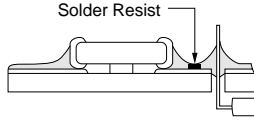
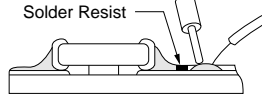
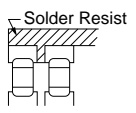
	Placing Close to Chassis	Placing of Chip Components and Leaded Components	Placing of Leaded Components after Chip Component	Lateral Mounting
Incorrect				
Correct				

Continued on the following page. 



**Notice**

Continued from the preceding page.

(2) Land Dimensions

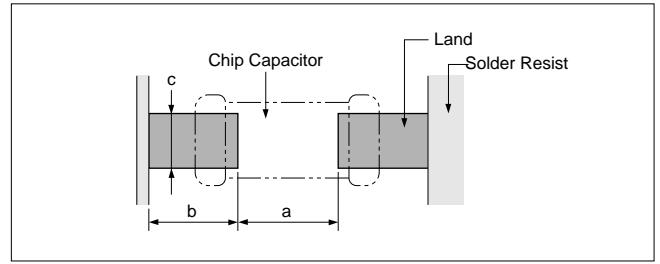

Table 1 Flow Soldering Method

Part Number	Dimensions	Dimensions (L×W)	a	b	c
GRM18 GQM18		1.6×0.8	0.6–1.0	0.8–0.9	0.6–0.8
GRM21 GQM21		2.0×1.25	1.0–1.2	0.9–1.0	0.8–1.1
GRM31		3.2×1.6	2.2–2.6	1.0–1.1	1.0–1.4
LLL21		1.25×2.0	0.4–0.7	0.5–0.7	1.4–1.8
LLL31		1.6×3.2	0.6–1.0	0.8–0.9	2.6–2.8
ERB18		1.6×0.8	0.6–1.0	0.8–0.9	0.6–0.8
ERB21		2.0×1.25	1.0–1.2	0.9–1.0	0.8–1.1

(in mm)

Table 2 Reflow Soldering Method

Part Number	Dimensions	Dimensions (L×W)	a	b	c
GRM02		0.4×0.2	0.16–0.2	0.12–0.18	0.2–0.23
GRM03 GJM03		0.6×0.3	0.2–0.3	0.2–0.35	0.2–0.4
GRM15 GJM15		1.0×0.5	0.3–0.5	0.35–0.45	0.4–0.6
GRM18 GQM18		1.6×0.8	0.6–0.8	0.6–0.7	0.6–0.8
GRM21 GQM21		2.0×1.25	1.0–1.2	0.6–0.7	0.8–1.1
GRM31		3.2×1.6	2.2–2.4	0.8–0.9	1.0–1.4
GRM32		3.2×2.5	2.0–2.4	1.0–1.2	1.8–2.3
GRM43		4.5×3.2	3.0–3.5	1.2–1.4	2.3–3.0
GRM55		5.7×5.0	4.0–4.6	1.4–1.6	3.5–4.8
LLL18		0.8×1.6	0.2–0.4	0.3–0.4	1.0–1.4
LLL21		1.25×2.0	0.4–0.6	0.3–0.5	1.4–1.8
LLL31		1.6×3.2	0.6–0.8	0.6–0.7	2.6–2.8
ERB18		1.6×0.8	0.6–0.8	0.6–0.7	0.6–0.8
ERB21		2.0×1.25	1.0–1.2	0.6–0.7	0.8–1.1
ERB32		3.2×2.5	2.0–2.4	1.0–1.2	1.8–2.3

(in mm)

Continued on the following page.

## Notice

Continued from the preceding page.

### ● GNM, LLA Series for reflow soldering method

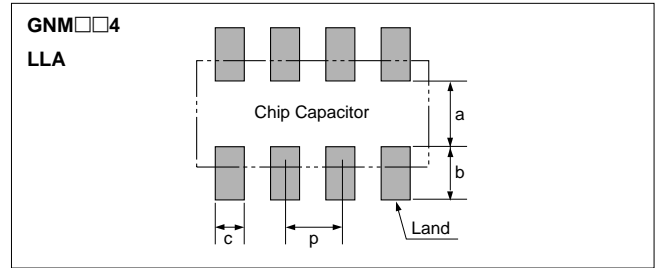
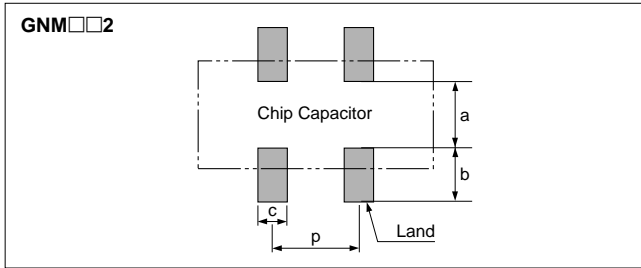

Table 3 GNM, LLA Series for Reflow Soldering Land Dimensions

Part Number	Dimensions (mm)					
	L	W	a	b	c	p
<b>GNM1M2</b>	1.37	1.0	0.45 to 0.5	0.5 to 0.55	0.3 to 0.35	0.64±0.1
<b>GNM212</b>	2.0	1.25	0.6 to 0.7	0.5 to 0.7	0.4 to 0.5	1.0±0.1
<b>GNM214</b>	2.0	1.25	0.6 to 0.7	0.5 to 0.7	0.25 to 0.35	0.5±0.05
<b>GNM314</b>	3.2	1.6	0.8 to 1.0	0.7 to 0.9	0.3 to 0.4	0.8±0.05
<b>LLA18</b>	1.6	0.8	0.45 to 0.55	0.25 to 0.35	0.15 to 0.25	0.4
<b>LLA21</b>	2.0	1.25	0.7 to 0.8	0.4 to 0.6	0.2 to 0.3	0.5
<b>LLA31</b>	3.2	1.6	0.8 to 1.0	0.7 to 0.9	0.3 to 0.4	0.8

### ● LLM Series for reflow soldering method

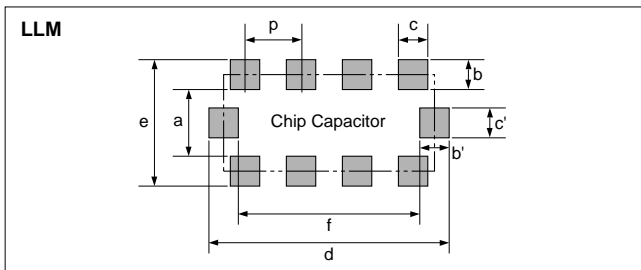

Table 4 LLM Series for Reflow Soldering Land Dimensions

Part Number	Dimensions (mm)						
	a	b, b'	c, c'	d	e	f	p
<b>LLM21</b>	0.6 to 0.8	(0.3 to 0.5)	0.3	2.0 to 2.6	1.3 to 1.8	1.4 to 1.6	0.5
<b>LLM31</b>	1.0	(0.3 to 0.5)	0.4	3.2 to 3.6	1.6 to 2.0	2.6	0.8

$$b=(c-e)/2, b'=(d-f)/2$$

## 2. Adhesive Application

- Thin or insufficient adhesive causes chips to loosen or become disconnected when flow soldered. The amount of adhesive must be more than dimension c shown in the drawing below to obtain enough bonding strength. The chip's electrode thickness and land thickness must be taken into consideration.
- Low viscosity adhesive causes chips to slip after mounting. Adhesive must have a viscosity of 5000Pa·s (500ps) min. (at 25°C)
- Adhesive Coverage\*

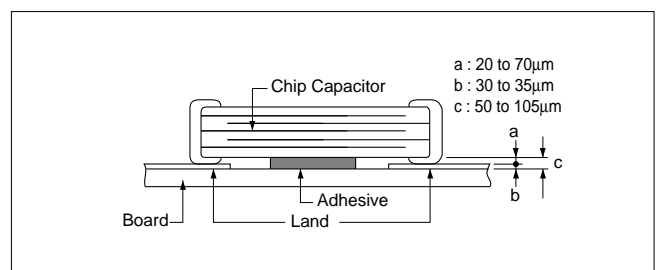

Part Number	Adhesive Coverage*
<b>GRM18, GQM18</b>	0.05mg min.
<b>GRM21, LLL21, GQM21</b>	0.1mg min.
<b>GRM31, LLL31</b>	0.15mg min.

\*Nominal Value

Continued on the following page. ↗

**Notice**

☐ Continued from the preceding page.

**3. Adhesive Curing**

Insufficient curing of the adhesive causes chips to disconnect during flow soldering and causes deteriorated insulation resistance between outer electrodes due to moisture absorption.  
 Control curing temperature and time in order to prevent insufficient hardening.

**Inverting the PCB**

Make sure not to impose an abnormal mechanical shock on the PCB.

**4. Flux Application**

- An excessive amount of flux generates a large quantity of flux gas, causing deteriorated solderability. So apply flux thinly and evenly throughout. (A foaming system is generally used for flow soldering).
- Flux containing too high a percentage of halide may cause corrosion of the outer electrodes unless sufficiently

cleaned. Use flux with a halide content of 0.2wt% max. But do not use strong acidic flux. Wash thoroughly because water soluble flux causes deteriorated insulation resistance between outer electrodes unless sufficiently cleaned.

**5. Flow Soldering**

- Set temperature and time to ensure that leaching of the outer electrode does not exceed 25% of the chip end area as a single chip (full length of the edge A-B-C-D shown below) and 25% of the length A-B shown below as mounted on substrate.

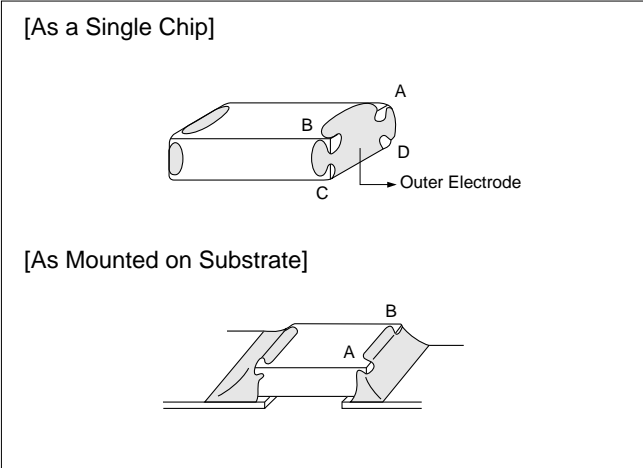

(Reference Data 6. Thermal shock)  
 (Reference Data 7. Solder heat resistance)

**Others**

1. Resin Coating  
 When selecting resin materials, select those with low contraction.
2. Circuit Design  
 These capacitors on this catalog are not safety recognized products
3. Remarks

The above notices are for standard applications and conditions. Contact us when the products are used in special mounting conditions. Select optimum conditions for operation as they determine the reliability of the product after assembly. The data here in are given in typical values, not guaranteed ratings.

## Reference Data

### 1. Solderability

#### (1) Test Method

Subject the chip capacitor to the following conditions.  
 Then apply flux (a ethanol solution of 25% rosin) to the chip and dip it in 230°C eutectic solder for 2 seconds.

Conditions :

Expose prepared at room temperature (for 6 months and 12 months, respectively)

Prepared at high temperature (for 100 hours at 85°C)

Prepared left at high humidity (for 100 hours under 90%RH to 95%RH at 40°C)

#### (2) Test Samples

GRM21 : Products for flow/reflow soldering.

#### (3) Acceptance Criteria

With a 60-power optical microscope, measure the surface area of the outer electrode that is covered with solder.

#### (4) Results

Refer to Table 1.

Table 1

Sample	Initial State	Prepared at Room Temperature		Prepared at High Temperature for 100 Hours at 85°C	Prepared at High Humidity for 100 Hours at 90 to 95% RH and 40°C
		6 months	12 months		
GRM21 for flow/reflow soldering	95 to 100%	95 to 100%	95%	90 to 95%	95%

### 2. Board Bending Strength for Solder Fillet Height

#### (1) Test Method

Solder the chip capacitor to the test PCB with the amount of solder paste necessary to achieve the fillet heights.  
 Then bend the PCB using the method illustrated and measure capacitance.

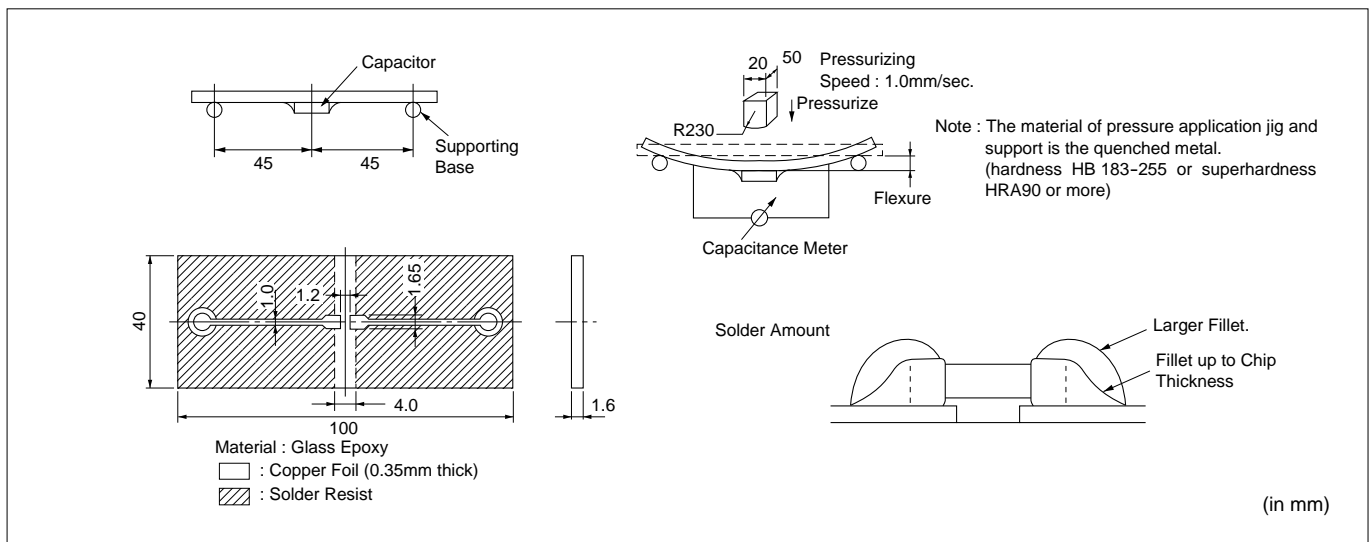

#### (2) Test Samples

GRM21 5C/R7/F5 Characteristics T=0.6mm

#### (3) Acceptance Criteria

Products shall be determined to be defective if the change in capacitance has exceeded the values specified in Table 2.

Table 2

Characteristics	Change in Capacitance
5C	Within $\pm 5\%$ or $\pm 0.5\text{pF}$ , whichever is greater
R7	Within $\pm 12.5\%$
F5	Within $\pm 20\%$

Continued on the following page.

## Reference Data

Continued from the preceding page.

### (4) Results

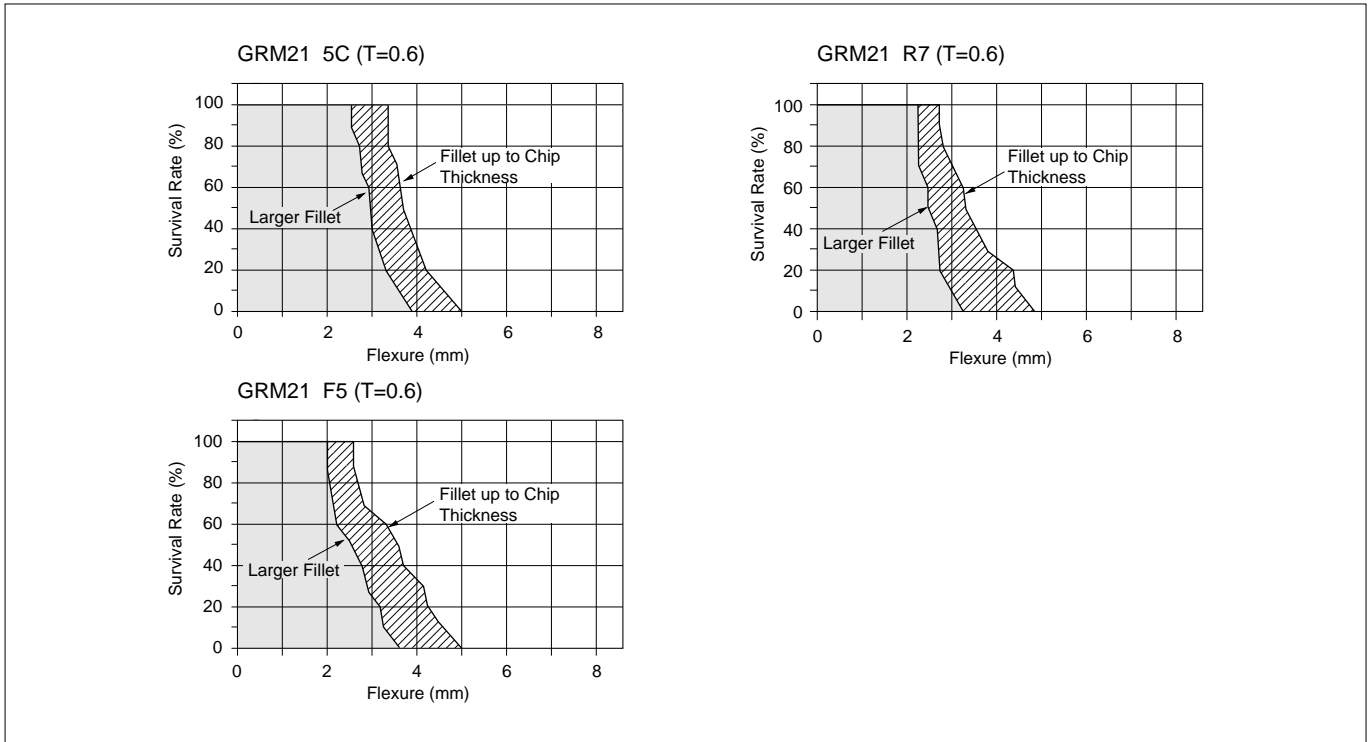

### 3. Temperature Cycling for Solder Fillet Height

#### (1) Test Method

Solder the chips to the substrate various test fixtures using sufficient amounts of solder to achieve the required fillet height. Then subject the fixtures to the cycle illustrated below 200 times.

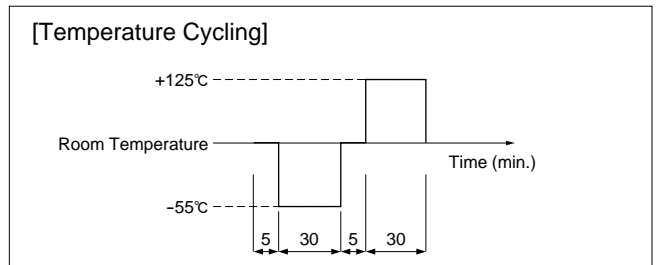

#### ① Solder Amount

Alumina substrates are typically designed for reflow soldering.

Glass epoxy or paper phenol substrates are typically used for flow soldering.

#### ② Material

Alumina (Thickness : 0.64mm)

Glass epoxy (Thickness : 1.64mm)

Paper phenol (Thickness : 1.64mm)

#### [Solder Amount]

Substrate		Alumina	Glass Epoxy or Paper Phenol
Solder Amount	①		
	②		
	③		
Solder to be used		6X4 Eutectic solder	

#### ③ Land Dimension

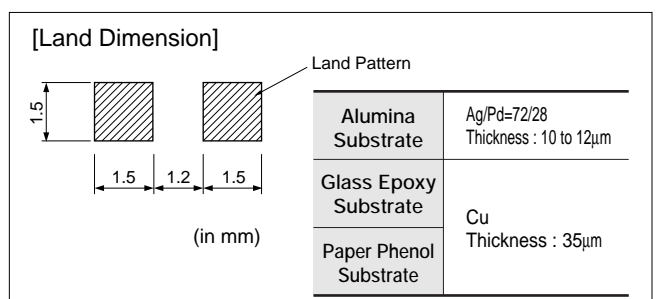

Continued on the following page.

## Reference Data

Continued from the preceding page.

### (2) Test Samples

GRM21 5C/R7/F5 Characteristics T=0.6mm

### (3) Acceptance Criteria

Products are determined to be defective if the change in capacitance has exceeded the values specified in Table 3.

Table 3

Characteristics	Change in Capacitance
5C	Within $\pm 2.5\%$ or $\pm 0.25\text{pF}$ , whichever is greater
R7	Within $\pm 7.5\%$
F5	Within $\pm 20\%$

### (4) Results

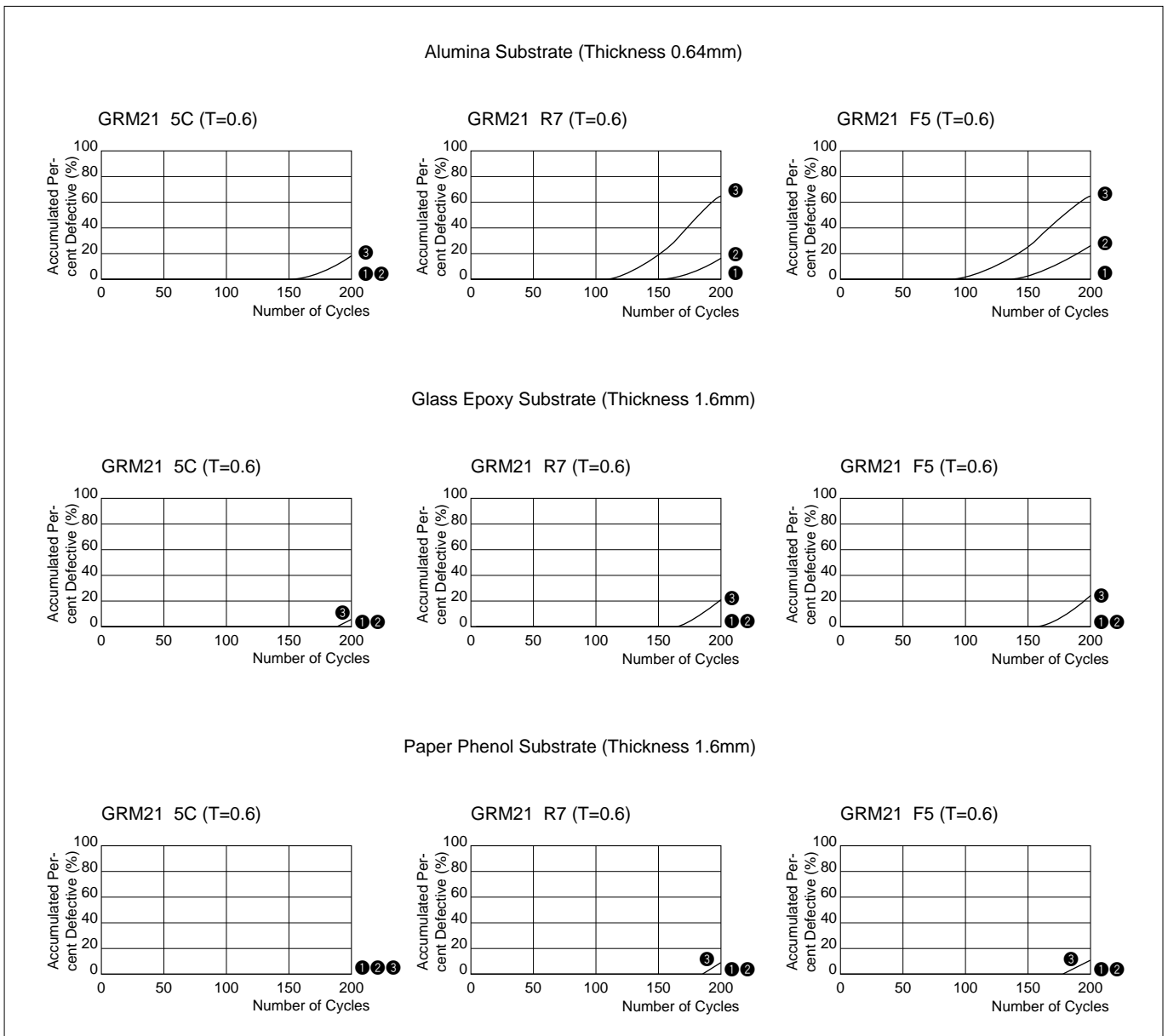

Continued on the following page.

## Reference Data

Continued from the preceding page.

### 4. Board Bending Strength for Board Material

#### (1) Test Method

Solder the chip to the test board. Then bend the board using the method illustrated below, to measure capacitance.

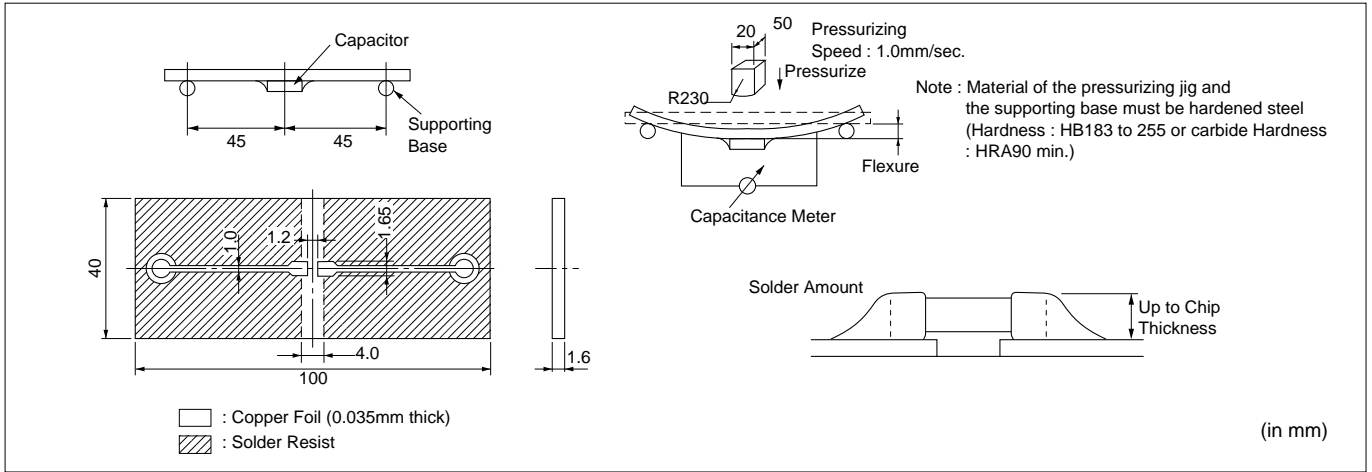

#### (2) Test Samples

GRM21 5C/R7/F5 Characteristics T=0.6mm typical

#### (3) Acceptance Criteria

Products should be determined to be defective if the change in capacitance has exceeded the values specified in Table 4.

Table 4

Characteristics	Change in Capacitance
<b>5C</b>	Within $\pm 5\%$ or $\pm 0.5\text{pF}$ , whichever is greater
<b>R7</b>	Within $\pm 12.5\%$
<b>F5</b>	Within $\pm 20\%$

#### (4) Results

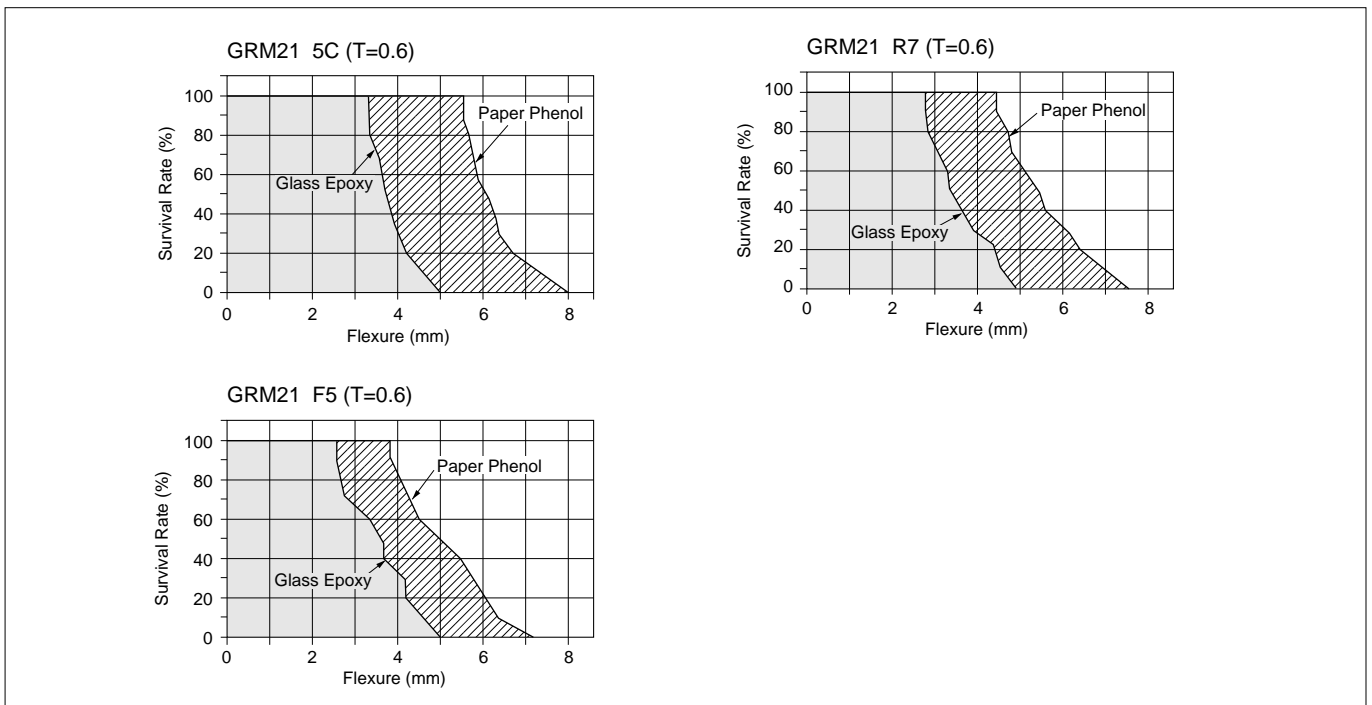

Continued on the following page.

## Reference Data

Continued from the preceding page.

### 5. Break Strength

#### (1) Test Method

Place the chip on a steel plate as illustrated on the right. Increase load applied to a point near the center of the test sample.

#### (2) Test Samples

GRM21 5C/R7/F5 Characteristics  
 GRM31 5C/R7/F5 Characteristics

#### (3) Acceptance Criteria

Define the load that has caused the chip to break or crack, as the bending force.

#### (4) Explanation

Break strength, P, is proportionate to the square of the thickness of the ceramic element and is expressed as a curve of secondary degree.

The formula is :

$$P = \frac{2\gamma WT^2}{3L} \quad (\text{N})$$

- W : Width of ceramic element (mm)
- T : Thickness of element (mm)
- L : Distance between fulcrums (mm)
- $\gamma$  : Bending stress (N/mm<sup>2</sup>)

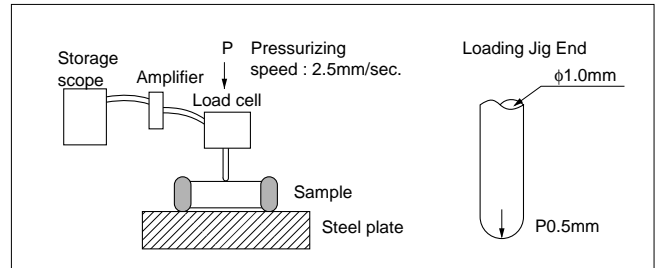

Chip Size	L	W	$\gamma$		
			5C Characteristics	R7 Characteristics	F5 Characteristics
<b>GRM21</b>	1.5	1.2	300	180	160
<b>GRM31</b>	2.7	1.5			

(in mm)

#### (5) Results

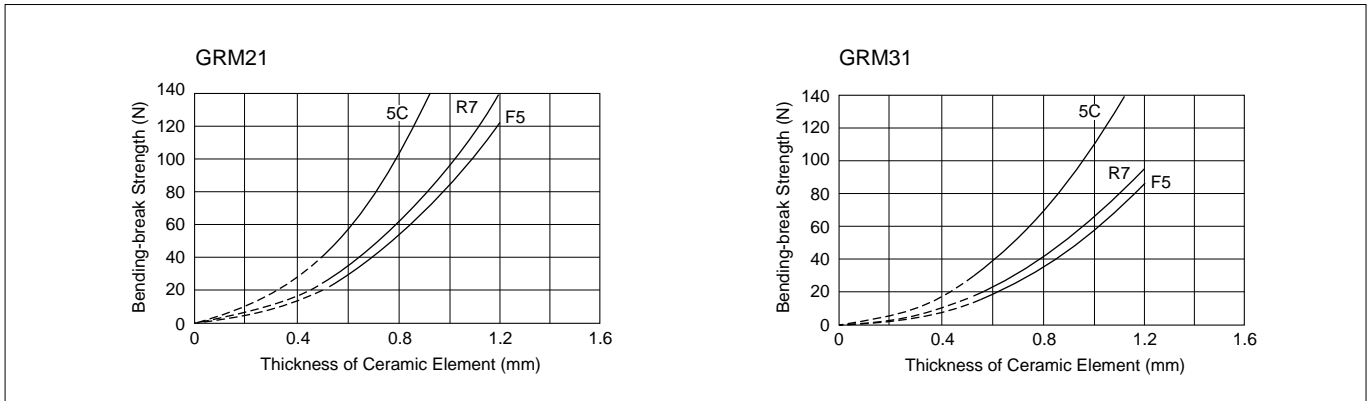

### 6. Thermal Shock

#### (1) Test method

After applying flux (an ethanol solution of 25% rosin), dip the chip in a solder bath (6X4 eutectic solder) in accordance with the following conditions :

#### (2) Test samples

GRM21 5C/R7/F5 Characteristics T=0.6mm typical

#### (3) Acceptance criteria

Visually inspect the test sample with a 60-power optical microscope. Chips exhibiting breaks or cracks shall be determined to be defective.

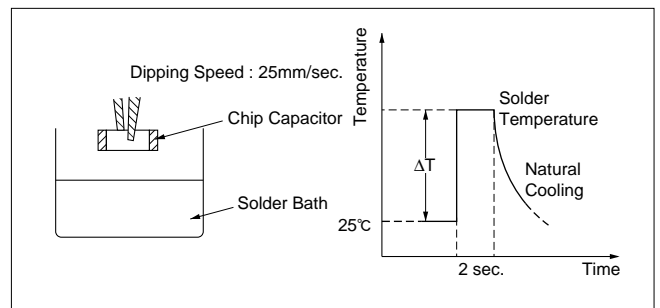

Continued on the following page. ↗



## Reference Data

Continued from the preceding page.

### (4) Results

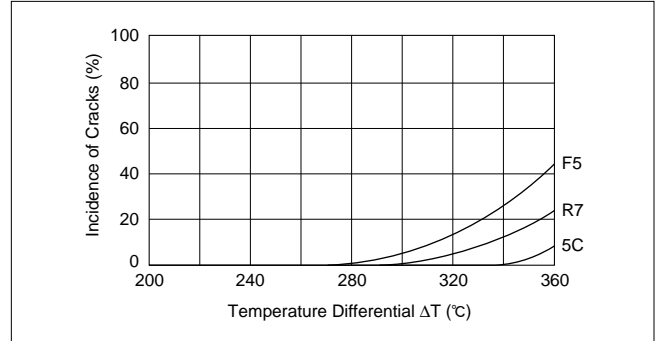

## 7. Solder Heat Resistance

### (1) Test Method

#### ① Reflow soldering :

Apply about 300 μm of solder paste over the alumina substrate. After reflow soldering, remove the chip and check for leaching that may have occurred on the outer electrode.

#### ② Flow soldering :

After dipping the test sample with a pair of tweezers in wave solder (eutectic solder), check for leaching that may have occurred on the outer electrode.

#### ③ Dip soldering :

After dipping the test sample with a pair of tweezers in static solder (eutectic solder), check for leaching that may have occurred on the outer electrode.

#### ④ Flux to be used : An ethanol solution of 25% rosin.

### (2) Test samples

GRM21 : For flow/reflow soldering T=0.6mm

### (3) Acceptance criteria

The starting time of leaching should be defined as the time when the outer electrode has lost 25% of the total edge length of A-B-C-D as illustrated :

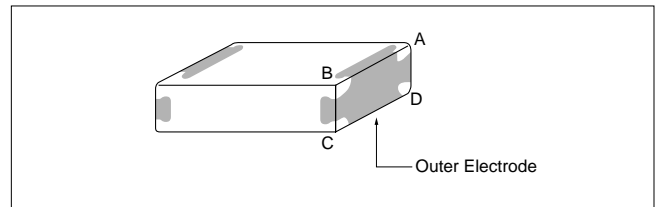

### (4) Results

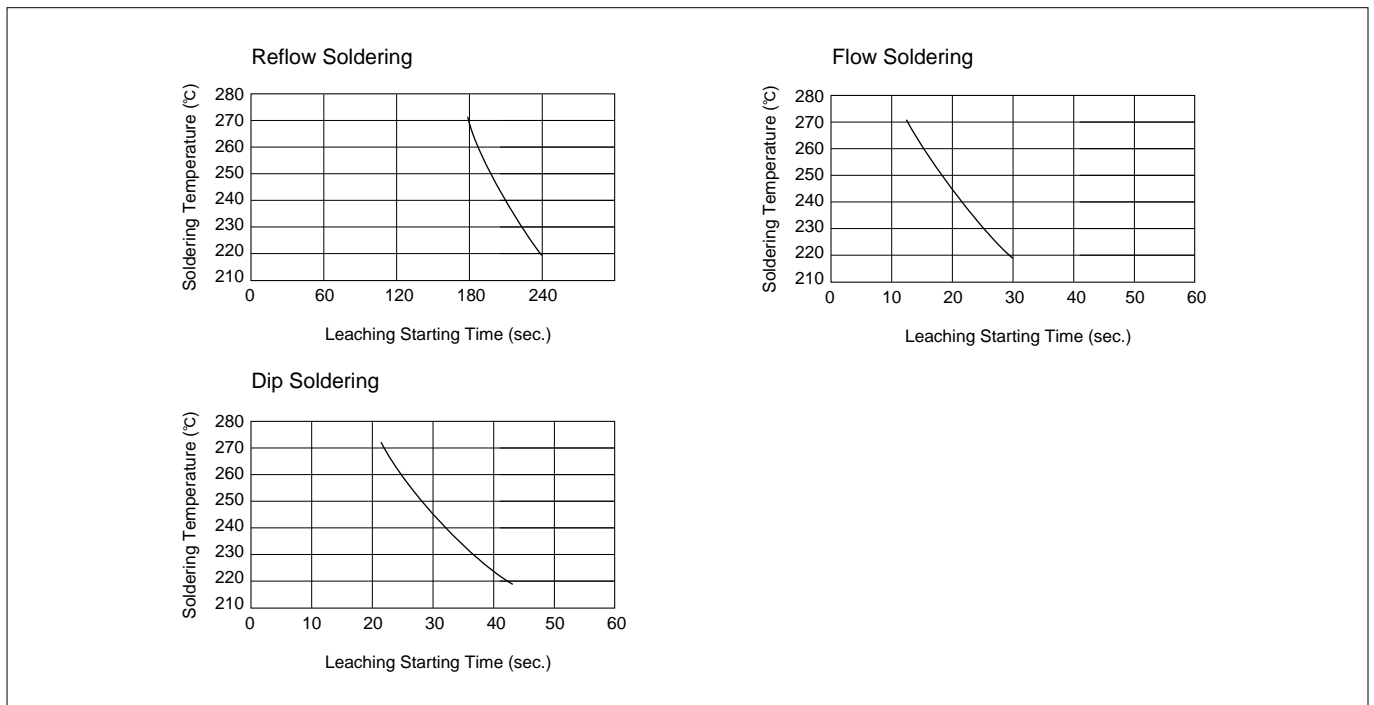

Continued on the following page. ↗

## Reference Data

☐ Continued from the preceding page.

### 8. Thermal Shock when Making Corrections with a Soldering Iron

#### (1) Test Method

Apply a soldering iron meeting the conditions below to the soldered joint of a chip that has been soldered to a paper phenol board, while supplying wire solder. (Note: the soldering iron tip should not directly touch the ceramic element of the chip.)

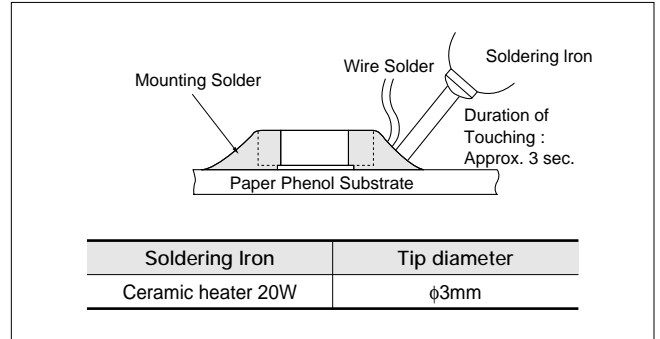

#### (2) Test Samples

GRM21 5C/R7/F5 Characteristics T=0.6mm

#### (3) Acceptance Criteria for Defects

Observe the appearance of the test sample with a 60-power optical microscope. Those units displaying any breaks or cracks are determined to be defective.

#### (4) Results

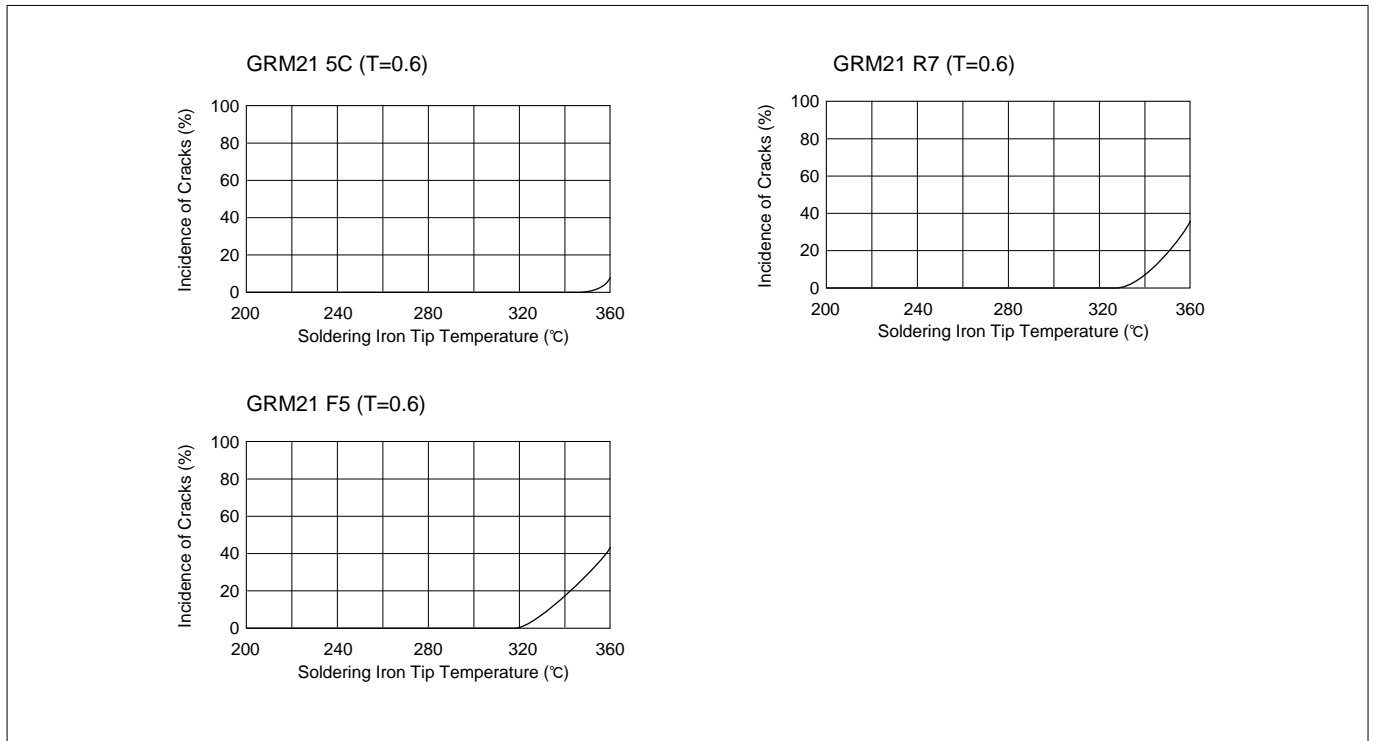

# Chip Monolithic Ceramic Capacitors



## Medium Voltage Low Dissipation Factor

### ■ Features

1. Murata's original internal electrode structure realizes high flash-over voltage.
2. A new monolithic structure for small, surface-mountable devices capable of operating at high voltage levels.
3. Sn-plated external electrodes realize good solderability.
4. Use the GRM21/31 type with flow or reflow soldering, and other types with reflow soldering only.
5. Low-loss and suitable for high frequency circuits

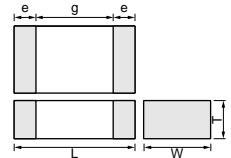

Part Number	Dimensions (mm)				
	L	W	T	e min.	g min.
GRM21A	2.0 ±0.2	1.25 ±0.2	1.0 +0, -0.3	0.3	0.7
GRM31A	3.2 ±0.2	1.6 ±0.2	1.25 +0, -0.3		1.5*
GRM31B			1.0 +0, -0.3		
GRM32A	3.2 ±0.2	2.5 ±0.2	1.25 +0, -0.3		
GRM32B			1.0 +0, -0.3		
GRM42A	4.5 ±0.3	2.0 ±0.2	2.0 ±0.3		2.9
GRM42D			2.0 ±0.3		

\* GRM31A7U3D, GRM32A7U3D, GRM32B7U3D : 1.8mm min.

### ■ Applications

1. Ideal for use on high frequency pulse circuits such as snubber circuits for switching power supplies, DC-DC converters, ballasts (inverter fluorescent lamps), etc.
2. Ideal for use as the ballast in liquid crystal back lighting inverters.
3. Please contact our sales representatives or engineers before using our products for other applications not specified above.

### SL/U2J Characteristics

Part Number	Rated Voltage (V)	TC Code (Standard)	Capacitance (pF)	Length L (mm)	Width W (mm)	Thickness T (mm)	Electrode g min. (mm)	Electrode e (mm)
GRM21A7U2E101JW31D	DC250	U2J (EIA)	100 ±5%	2.0	1.25	1.0	0.7	0.3 min.
GRM21A7U2E151JW31D	DC250	U2J (EIA)	150 ±5%	2.0	1.25	1.0	0.7	0.3 min.
GRM21A7U2E221JW31D	DC250	U2J (EIA)	220 ±5%	2.0	1.25	1.0	0.7	0.3 min.
GRM21A7U2E331JW31D	DC250	U2J (EIA)	330 ±5%	2.0	1.25	1.0	0.7	0.3 min.
GRM21A7U2E471JW31D	DC250	U2J (EIA)	470 ±5%	2.0	1.25	1.0	0.7	0.3 min.
GRM21A7U2E681JW31D	DC250	U2J (EIA)	680 ±5%	2.0	1.25	1.0	0.7	0.3 min.
GRM21A7U2E102JW31D	DC250	U2J (EIA)	1000 ±5%	2.0	1.25	1.0	0.7	0.3 min.
GRM21A7U2E152JW31D	DC250	U2J (EIA)	1500 ±5%	2.0	1.25	1.0	0.7	0.3 min.
GRM21A7U2E222JW31D	DC250	U2J (EIA)	2200 ±5%	2.0	1.25	1.0	0.7	0.3 min.
GRM31A7U2E332JW31D	DC250	U2J (EIA)	3300 ±5%	3.2	1.6	1.0	1.5	0.3 min.
GRM31A7U2E472JW31D	DC250	U2J (EIA)	4700 ±5%	3.2	1.6	1.0	1.5	0.3 min.
GRM31B7U2E682JW31L	DC250	U2J (EIA)	6800 ±5%	3.2	1.6	1.25	1.5	0.3 min.
GRM31B7U2E103JW31L	DC250	U2J (EIA)	10000 ±5%	3.2	1.6	1.25	1.5	0.3 min.
GRM31A7U2J100JW31D	DC630	U2J (EIA)	10 ±5%	3.2	1.6	1.0	1.5	0.3 min.
GRM31A7U2J150JW31D	DC630	U2J (EIA)	15 ±5%	3.2	1.6	1.0	1.5	0.3 min.
GRM31A7U2J220JW31D	DC630	U2J (EIA)	22 ±5%	3.2	1.6	1.0	1.5	0.3 min.
GRM31A7U2J330JW31D	DC630	U2J (EIA)	33 ±5%	3.2	1.6	1.0	1.5	0.3 min.
GRM31A7U2J470JW31D	DC630	U2J (EIA)	47 ±5%	3.2	1.6	1.0	1.5	0.3 min.
GRM31A7U2J680JW31D	DC630	U2J (EIA)	68 ±5%	3.2	1.6	1.0	1.5	0.3 min.
GRM31A7U2J101JW31D	DC630	U2J (EIA)	100 ±5%	3.2	1.6	1.0	1.5	0.3 min.
GRM31A7U2J151JW31D	DC630	U2J (EIA)	150 ±5%	3.2	1.6	1.0	1.5	0.3 min.
GRM31A7U2J221JW31D	DC630	U2J (EIA)	220 ±5%	3.2	1.6	1.0	1.5	0.3 min.
GRM31A7U2J331JW31D	DC630	U2J (EIA)	330 ±5%	3.2	1.6	1.0	1.5	0.3 min.
GRM31A7U2J471JW31D	DC630	U2J (EIA)	470 ±5%	3.2	1.6	1.0	1.5	0.3 min.
GRM31A7U2J681JW31D	DC630	U2J (EIA)	680 ±5%	3.2	1.6	1.0	1.5	0.3 min.

Continued on the following page.

Continued from the preceding page.

Part Number	Rated Voltage (V)	TC Code (Standard)	Capacitance (pF)	Length L (mm)	Width W (mm)	Thickness T (mm)	Electrode g min. (mm)	Electrode e (mm)
GRM31A7U2J102JW31D	DC630	U2J (EIA)	1000 ±5%	3.2	1.6	1.0	1.5	0.3 min.
GRM32A7U2J152JW31D	DC630	U2J (EIA)	1500 ±5%	3.2	2.5	1.0	1.5	0.3 min.
GRM32A7U2J222JW31D	DC630	U2J (EIA)	2200 ±5%	3.2	2.5	1.0	1.5	0.3 min.
GRM31A7U3A100JW31D	DC1000	U2J (EIA)	10 ±5%	3.2	1.6	1.0	1.5	0.3 min.
GRM31A7U3A150JW31D	DC1000	U2J (EIA)	15 ±5%	3.2	1.6	1.0	1.5	0.3 min.
GRM31A7U3A220JW31D	DC1000	U2J (EIA)	22 ±5%	3.2	1.6	1.0	1.5	0.3 min.
GRM31A7U3A330JW31D	DC1000	U2J (EIA)	33 ±5%	3.2	1.6	1.0	1.5	0.3 min.
GRM31A7U3A470JW31D	DC1000	U2J (EIA)	47 ±5%	3.2	1.6	1.0	1.5	0.3 min.
GRM31A7U3A680JW31D	DC1000	U2J (EIA)	68 ±5%	3.2	1.6	1.0	1.5	0.3 min.
GRM31A7U3A101JW31D	DC1000	U2J (EIA)	100 ±5%	3.2	1.6	1.0	1.5	0.3 min.
GRM31A7U3A151JW31D	DC1000	U2J (EIA)	150 ±5%	3.2	1.6	1.0	1.5	0.3 min.
GRM31A7U3A221JW31D	DC1000	U2J (EIA)	220 ±5%	3.2	1.6	1.0	1.5	0.3 min.
GRM31A7U3A331JW31D	DC1000	U2J (EIA)	330 ±5%	3.2	1.6	1.0	1.5	0.3 min.
GRM31B7U3A471JW31L	DC1000	U2J (EIA)	470 ±5%	3.2	1.6	1.25	1.5	0.3 min.
GRM31A7U3D100JW31D	DC2000	U2J (EIA)	10 ±5%	3.2	1.6	1.0	1.8	0.3 min.
GRM31A7U3D120JW31D	DC2000	U2J (EIA)	12 ±5%	3.2	1.6	1.0	1.8	0.3 min.
GRM31A7U3D150JW31D	DC2000	U2J (EIA)	15 ±5%	3.2	1.6	1.0	1.8	0.3 min.
GRM31A7U3D180JW31D	DC2000	U2J (EIA)	18 ±5%	3.2	1.6	1.0	1.8	0.3 min.
GRM31A7U3D220JW31D	DC2000	U2J (EIA)	22 ±5%	3.2	1.6	1.0	1.8	0.3 min.
GRM31A7U3D270JW31D	DC2000	U2J (EIA)	27 ±5%	3.2	1.6	1.0	1.8	0.3 min.
GRM31A7U3D330JW31D	DC2000	U2J (EIA)	33 ±5%	3.2	1.6	1.0	1.8	0.3 min.
GRM31A7U3D390JW31D	DC2000	U2J (EIA)	39 ±5%	3.2	1.6	1.0	1.8	0.3 min.
GRM31A7U3D470JW31D	DC2000	U2J (EIA)	47 ±5%	3.2	1.6	1.0	1.8	0.3 min.
GRM31A7U3D560JW31D	DC2000	U2J (EIA)	56 ±5%	3.2	1.6	1.0	1.8	0.3 min.
GRM31A7U3D680JW31D	DC2000	U2J (EIA)	68 ±5%	3.2	1.6	1.0	1.8	0.3 min.
GRM32A7U3D820JW31D	DC2000	U2J (EIA)	82 ±5%	3.2	2.5	1.0	1.8	0.3 min.
GRM32A7U3D101JW31D	DC2000	U2J (EIA)	100 ±5%	3.2	2.5	1.0	1.8	0.3 min.
GRM32A7U3D121JW31D	DC2000	U2J (EIA)	120 ±5%	3.2	2.5	1.0	1.8	0.3 min.
GRM32A7U3D151JW31D	DC2000	U2J (EIA)	150 ±5%	3.2	2.5	1.0	1.8	0.3 min.
GRM32B7U3D181JW31L	DC2000	U2J (EIA)	180 ±5%	3.2	2.5	1.25	1.8	0.3 min.
GRM32B7U3D221JW31L	DC2000	U2J (EIA)	220 ±5%	3.2	2.5	1.25	1.8	0.3 min.
GRM42D1X3F100JY02L	DC3150	SL (JIS)	10 ±5%	4.5	2.0	2.0	2.9	0.3 min.
GRM42D1X3F120JY02L	DC3150	SL (JIS)	12 ±5%	4.5	2.0	2.0	2.9	0.3 min.
GRM42D1X3F150JY02L	DC3150	SL (JIS)	15 ±5%	4.5	2.0	2.0	2.9	0.3 min.
GRM42D1X3F180JY02L	DC3150	SL (JIS)	18 ±5%	4.5	2.0	2.0	2.9	0.3 min.
GRM42D1X3F220JY02L	DC3150	SL (JIS)	22 ±5%	4.5	2.0	2.0	2.9	0.3 min.
GRM42A7U3F270JW31L	DC3150	U2J (EIA)	27 ±5%	4.5	2.0	1.0	2.9	0.3 min.
GRM42A7U3F330JW31L	DC3150	U2J (EIA)	33 ±5%	4.5	2.0	1.0	2.9	0.3 min.
GRM42A7U3F390JW31L	DC3150	U2J (EIA)	39 ±5%	4.5	2.0	1.0	2.9	0.3 min.
GRM42A7U3F470JW31L	DC3150	U2J (EIA)	47 ±5%	4.5	2.0	1.0	2.9	0.3 min.
GRM42A7U3F560JW31L	DC3150	U2J (EIA)	56 ±5%	4.5	2.0	1.0	2.9	0.3 min.
GRM42A7U3F680JW31L	DC3150	U2J (EIA)	68 ±5%	4.5	2.0	1.0	2.9	0.3 min.
GRM42A7U3F820JW31L	DC3150	U2J (EIA)	82 ±5%	4.5	2.0	1.0	2.9	0.3 min.
GRM42A7U3F101JW31L	DC3150	U2J (EIA)	100 ±5%	4.5	2.0	1.0	2.9	0.3 min.

## Application Specific Products, C0G Characteristics

Part Number	Rated Voltage (V)	TC Code (Standard)	Capacitance (pF)	Length L (mm)	Width W (mm)	Thickness T (mm)	Electrode g min. (mm)	Electrode e (mm)
GRM42A5C3F050DW01L	DC3150	C0G (EIA)	5.0 ±0.5pF	4.5	2.0	1.0	2.9	0.3 min.
GRM42A5C3F100JW01L	DC3150	C0G (EIA)	10 ±5%	4.5	2.0	1.0	2.9	0.3 min.
GRM42A5C3F120JW01L	DC3150	C0G (EIA)	12 ±5%	4.5	2.0	1.0	2.9	0.3 min.
GRM42A5C3F150JW01L	DC3150	C0G (EIA)	15 ±5%	4.5	2.0	1.0	2.9	0.3 min.
GRM42A5C3F180JW01L	DC3150	C0G (EIA)	18 ±5%	4.5	2.0	1.0	2.9	0.3 min.
GRM42A5C3F220JW01L	DC3150	C0G (EIA)	22 ±5%	4.5	2.0	1.0	2.9	0.3 min.
GRM42A5C3F270JW01L	DC3150	C0G (EIA)	27 ±5%	4.5	2.0	1.0	2.9	0.3 min.
GRM42A5C3F330JW01L	DC3150	C0G (EIA)	33 ±5%	4.5	2.0	1.0	2.9	0.3 min.
GRM42A5C3F390JW01L	DC3150	C0G (EIA)	39 ±5%	4.5	2.0	1.0	2.9	0.3 min.
GRM42A5C3F470JW01L	DC3150	C0G (EIA)	47 ±5%	4.5	2.0	1.0	2.9	0.3 min.

Please contact us in case that the C0G char. DC3150V items are considered to use for the application which is not LCD back lighting inverters circuit.

## Specifications and Test Methods

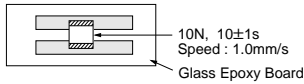
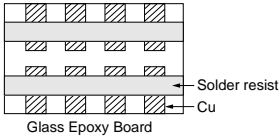
No.	Item	Specifications	Test Method												
1	Operating Temperature Range	-55 to +125°C													
2	Appearance	No defects or abnormalities	Visual inspection												
3	Dimensions	Within the specified dimension	Using calipers												
4	Dielectric Strength	No defects or abnormalities	<p>No failure should be observed when voltage in Table is applied between the terminations for 1 to 5 sec., provided the charge/discharge current is less than 50mA.</p> <table border="1"> <thead> <tr> <th>Rated voltage</th> <th>Test voltage</th> </tr> </thead> <tbody> <tr> <td>DC250V</td> <td>200% of the rated voltage</td> </tr> <tr> <td>DC630V</td> <td>150% of the rated voltage</td> </tr> <tr> <td>DC1kV, DC2kV</td> <td>120% of the rated voltage</td> </tr> <tr> <td>DC3.15kV</td> <td>DC4095V</td> </tr> </tbody> </table>	Rated voltage	Test voltage	DC250V	200% of the rated voltage	DC630V	150% of the rated voltage	DC1kV, DC2kV	120% of the rated voltage	DC3.15kV	DC4095V		
Rated voltage	Test voltage														
DC250V	200% of the rated voltage														
DC630V	150% of the rated voltage														
DC1kV, DC2kV	120% of the rated voltage														
DC3.15kV	DC4095V														
5	Insulation Resistance (I.R.)	More than 10,000MΩ	The insulation resistance should be measured with DC500±50V (DC250±25V in case of rated voltage : DC250V) and within 60±5 sec. of charging.												
6	Capacitance	Within the specified tolerance	The capacitance/Q should be measured at 20°C at the frequency and voltage shown as follows.												
7	Q	C0G/U2J char. : 1,000 min. SL char. : 400+20C*1 min.	<table border="1"> <thead> <tr> <th>Capacitance</th> <th>Frequency</th> <th>Voltage</th> </tr> </thead> <tbody> <tr> <td>C&lt;1,000pF</td> <td>1±0.2MHz</td> <td>AC0.5 to 5V(r.m.s.)</td> </tr> <tr> <td>C≥1,000pF</td> <td>1±0.2kHz</td> <td>AC1±0.2V(r.m.s.)</td> </tr> </tbody> </table>	Capacitance	Frequency	Voltage	C<1,000pF	1±0.2MHz	AC0.5 to 5V(r.m.s.)	C≥1,000pF	1±0.2kHz	AC1±0.2V(r.m.s.)			
Capacitance	Frequency	Voltage													
C<1,000pF	1±0.2MHz	AC0.5 to 5V(r.m.s.)													
C≥1,000pF	1±0.2kHz	AC1±0.2V(r.m.s.)													
8	Capacitance Temperature Characteristics	Temp. Coefficient C0G char. : 0±30ppm/°C (Temp. Range : +25 to +125°C) 0+30, -72ppm/°C (Temp. Range : -55 to +25°C) U2J char. : -750±120 ppm/°C (Temp. Range : +25 to +125°C) -750+120, -347 ppm/°C (Temp. Range : -55 to +25°C) SL char. : +350 to -1000 ppm/°C (Temp. Range : +20 to +85°C)	<p>The temperature coefficient is determined using the capacitance measured in step 3 as a reference.</p> <p>When cycling the temperature sequentially from step 1 through 5 (SL char. : +20 to +85°C) the capacitance should be within the specified tolerance for the temperature coefficient.</p> <table border="1"> <thead> <tr> <th>Step</th> <th>Temperature (°C)</th> </tr> </thead> <tbody> <tr> <td>1</td> <td>25±2 (20±2 for SL char.)</td> </tr> <tr> <td>2</td> <td>Min. Operating Temp.±3</td> </tr> <tr> <td>3</td> <td>25±2 (20±2 for SL char.)</td> </tr> <tr> <td>4</td> <td>Max. Operating Temp.±2</td> </tr> <tr> <td>5</td> <td>25±2 (20±2 for SL char.)</td> </tr> </tbody> </table>	Step	Temperature (°C)	1	25±2 (20±2 for SL char.)	2	Min. Operating Temp.±3	3	25±2 (20±2 for SL char.)	4	Max. Operating Temp.±2	5	25±2 (20±2 for SL char.)
Step	Temperature (°C)														
1	25±2 (20±2 for SL char.)														
2	Min. Operating Temp.±3														
3	25±2 (20±2 for SL char.)														
4	Max. Operating Temp.±2														
5	25±2 (20±2 for SL char.)														
9	Adhesive Strength of Termination	No removal of the terminations or other defect should occur.	<p>Solder the capacitor to the testing jig (glass epoxy board) shown in Fig. 1 using a eutectic solder.</p> <p>Then apply 10N force in the direction of the arrow.</p> <p>The soldering should be done either with an iron or using the reflow method and should be conducted with care so that the soldering is uniform and free of defects such as heat shock.</p>  <p>Fig. 1</p>												
10	Appearance	No defects or abnormalities	<p>Solder the capacitor to the test jig (glass epoxy board).</p> <p>The capacitor should be subjected to a simple harmonic motion having a total amplitude of 1.5mm, the frequency being varied uniformly between the approximate limits of 10 and 55Hz. The frequency range, from 10 to 55Hz and return to 10Hz, should be traversed in approximately 1 min. This motion should be applied for a period of 2 hrs. in each 3 mutually perpendicular directions (total of 6 hrs.).</p> 												
	Capacitance	Within the specified tolerance													
	Q	C0G/U2J char. : 1,000 min. SL char. : 400+20C*1 min.													

\*1 "C" expresses nominal capacitance value (pF).

Continued on the following page. ↗

## Specifications and Test Methods

Continued from the preceding page.

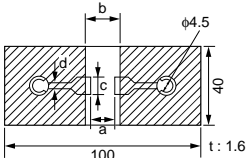
No.	Item	Specifications	Test Method																							
11	Deflection	No cracking or marking defects should occur.	Solder the capacitor to the testing jig (glass epoxy board) shown in Fig. 2 using a eutectic solder. Then apply a force in the direction shown in Fig. 3. The soldering should be done either with an iron or using the reflow method and should be conducted with care so that the soldering is uniform and free of defects such as heat shock.																							
		 <table border="1" style="margin: 10px auto; border-collapse: collapse;"> <thead> <tr> <th rowspan="2">L×W (mm)</th> <th colspan="4">Dimension (mm)</th> </tr> <tr> <th>a</th> <th>b</th> <th>c</th> <th>d</th> </tr> </thead> <tbody> <tr> <td>2.0×1.25</td> <td>1.2</td> <td>4.0</td> <td>1.65</td> <td rowspan="4" style="text-align: center; vertical-align: middle;">1.0</td> </tr> <tr> <td>3.2×1.6</td> <td>2.2</td> <td>5.0</td> <td>2.0</td> </tr> <tr> <td>3.2×2.5</td> <td>2.2</td> <td>5.0</td> <td>2.9</td> </tr> <tr> <td>4.5×2.0</td> <td>3.5</td> <td>7.0</td> <td>2.4</td> </tr> </tbody> </table> <p style="text-align: center;">Fig. 2</p>		L×W (mm)	Dimension (mm)				a	b	c	d	2.0×1.25	1.2	4.0	1.65	1.0	3.2×1.6	2.2	5.0	2.0	3.2×2.5	2.2	5.0	2.9	4.5×2.0
L×W (mm)	Dimension (mm)																									
	a	b	c	d																						
2.0×1.25	1.2	4.0	1.65	1.0																						
3.2×1.6	2.2	5.0	2.0																							
3.2×2.5	2.2	5.0	2.9																							
4.5×2.0	3.5	7.0	2.4																							
12	Solderability of Termination	75% of the terminations are to be soldered evenly and continuously.	Immerse the capacitor in a solution of ethanol (JIS-K-8101) and rosin (JIS-K-5902) (25% rosin in weight proportion). Immerse in solder solution for 2±0.5 sec. Immersing speed : 25±2.5mm/s Temp. of solder : 245±5°C Lead Free Solder (Sn-3.0Ag-0.5Cu) 235±5°C H60A or H63A Eutectic Solder																							
13	Resistance to Soldering Heat	Appearance	No marking defects																							
		Capacitance Change	Within ±2.5%																							
		Q	C0G/U2J char. : 1,000 min. SL char. : 400+20C*2 min.																							
		I.R.	More than 10,000MΩ																							
		Dielectric Strength	In accordance with item No.4																							
14	Temperature Cycle	Appearance	No marking defects																							
		Capacitance Change	Within ±2.5%																							
		Q	C0G char. : 1,000 min. U2J char. : 500 min. SL char. : 400+20C*2 min.																							
		I.R.	More than 10,000MΩ																							
		Dielectric Strength	In accordance with item No.4																							
15	Humidity (Steady State)	Appearance	No marking defects																							
		Capacitance Change	Within ±5.0%																							
		Q	C0G/U2J char. : 350 min. SL char. : 275+5/2C*2 min.																							
		I.R.	More than 1,000MΩ																							
		Dielectric Strength	In accordance with item No.4																							
16	Life	Appearance	No marking defects																							
		Capacitance Change	Within ±3.0%																							
		Q	C0G/U2J char. : 350 min. SL char. : 275+5/2C*2 min.																							
		I.R.	More than 1,000MΩ																							
		Dielectric Strength	In accordance with item No.4																							

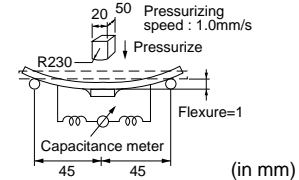

Fig. 3

Step	Temperature	Time
1	100 to 120°C	1 min.
2	170 to 200°C	1 min.

Step	Temperature (°C)	Time (min.)
1	Min. Operating Temp.±3	30±3
2	Room Temp.	2 to 3
3	Max. Operating Temp.±2	30±3
4	Room Temp.	2 to 3

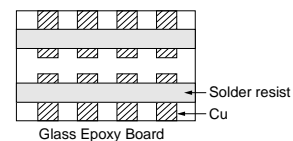

Fig. 4

\*1 "Room condition" Temperature : 15 to 35°C, Relative humidity : 45 to 75%, Atmospheric pressure : 86 to 106kPa  
 \*2 "C" expresses nominal capacitance value (pF).

# Chip Monolithic Ceramic Capacitors



## Medium Voltage High Capacitance for General-Use

### ■ Features

1. A new monolithic structure for small, high capacitance capable of operating at high voltage levels.
2. Sn-plated external electrodes realizes good solderability.
3. Use the GRM18/21/31 types with flow or reflow soldering, and other types with reflow soldering only.

### ■ Applications

1. Ideal for use as a hot-cold coupling for DC-DC converter.
2. Ideal for use on line filters and ringer detectors for telephones, facsimiles and modems.
3. Ideal for use on diode-snubber circuits for switching power supplies.

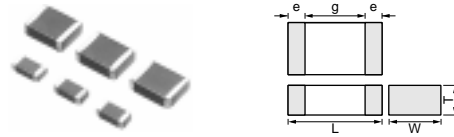

Part Number	Dimensions (mm)				
	L	W	T	e	g min.
GRM188	1.6 ±0.1	0.8 ±0.1	0.8 ±0.1	0.2 to 0.5	0.4
GRM21A	2.0 ±0.2	1.25 ±0.2	1.0 +0,-0.3		0.7
GRM21B			1.25 ±0.2		1.2
GRM31B	3.2 ±0.2	1.6 ±0.2	1.25 +0,-0.3		
GRM31C			1.6 ±0.2		
GRM32Q	3.2 ±0.3	2.5 ±0.2	1.5 +0,-0.3		
GRM32D			2.0 +0,-0.3		
GRM43Q	4.5 ±0.4	3.2 ±0.3	1.5 +0,-0.3		
GRM43D			2.0 +0,-0.3		
GRM55D	5.7 ±0.4	5.0 ±0.4	2.0 +0,-0.3		

Part Number	Rated Voltage (V)	TC Code (Standard)	Capacitance	Length L (mm)	Width W (mm)	Thickness T (mm)	Electrode g min. (mm)	Electrode e (mm)
GRM188R72E221KW07D	DC250	X7R (EIA)	220pF ±10%	1.6	0.8	0.8	0.4	0.2 to 0.5
GRM188R72E331KW07D	DC250	X7R (EIA)	330pF ±10%	1.6	0.8	0.8	0.4	0.2 to 0.5
GRM188R72E471KW07D	DC250	X7R (EIA)	470pF ±10%	1.6	0.8	0.8	0.4	0.2 to 0.5
GRM188R72E681KW07D	DC250	X7R (EIA)	680pF ±10%	1.6	0.8	0.8	0.4	0.2 to 0.5
GRM188R72E102KW07D	DC250	X7R (EIA)	1000pF ±10%	1.6	0.8	0.8	0.4	0.2 to 0.5
GRM21AR72E102KW01D	DC250	X7R (EIA)	1000pF ±10%	2.0	1.25	1.0	0.7	0.3 min.
GRM188R72E152KW07D	DC250	X7R (EIA)	1500pF ±10%	1.6	0.8	0.8	0.4	0.2 to 0.5
GRM21AR72E152KW01D	DC250	X7R (EIA)	1500pF ±10%	2.0	1.25	1.0	0.7	0.3 min.
GRM188R72E222KW07D	DC250	X7R (EIA)	2200pF ±10%	1.6	0.8	0.8	0.4	0.2 to 0.5
GRM21AR72E222KW01D	DC250	X7R (EIA)	2200pF ±10%	2.0	1.25	1.0	0.7	0.3 min.
GRM21AR72E332KW01D	DC250	X7R (EIA)	3300pF ±10%	2.0	1.25	1.0	0.7	0.3 min.
GRM21AR72E472KW01D	DC250	X7R (EIA)	4700pF ±10%	2.0	1.25	1.0	0.7	0.3 min.
GRM21AR72E682KW01D	DC250	X7R (EIA)	6800pF ±10%	2.0	1.25	1.0	0.7	0.3 min.
GRM21BR72E103KW03L	DC250	X7R (EIA)	10000pF ±10%	2.0	1.25	1.25	0.7	0.3 min.
GRM31BR72E153KW01L	DC250	X7R (EIA)	15000pF ±10%	3.2	1.6	1.25	1.2	0.3 min.
GRM31BR72E223KW01L	DC250	X7R (EIA)	22000pF ±10%	3.2	1.6	1.25	1.2	0.3 min.
GRM31CR72E333KW03L	DC250	X7R (EIA)	33000pF ±10%	3.2	1.6	1.6	1.2	0.3 min.
GRM31CR72E473KW03L	DC250	X7R (EIA)	47000pF ±10%	3.2	1.6	1.6	1.2	0.3 min.
GRM31BR72E683KW01L	DC250	X7R (EIA)	68000pF ±10%	3.2	1.6	1.25	1.2	0.3 min.
GRM32QR72E683KW01L	DC250	X7R (EIA)	68000pF ±10%	3.2	2.5	1.5	1.2	0.3 min.
GRM31CR72E104KW03L	DC250	X7R (EIA)	0.10µF ±10%	3.2	1.6	1.6	1.2	0.3 min.
GRM32DR72E104KW01L	DC250	X7R (EIA)	0.10µF ±10%	3.2	2.5	2.0	1.2	0.3 min.
GRM43QR72E154KW01L	DC250	X7R (EIA)	0.15µF ±10%	4.5	3.2	1.5	2.2	0.3 min.
GRM32DR72E224KW01L	DC250	X7R (EIA)	0.22µF ±10%	3.2	2.5	2.0	1.2	0.3 min.
GRM43DR72E224KW01L	DC250	X7R (EIA)	0.22µF ±10%	4.5	3.2	2.0	2.2	0.3 min.
GRM43DR72E334KW01L	DC250	X7R (EIA)	0.33µF ±10%	4.5	3.2	2.0	2.2	0.3 min.
GRM55DR72E334KW01L	DC250	X7R (EIA)	0.33µF ±10%	5.7	5.0	2.0	3.2	0.3 min.
GRM43DR72E474KW01L	DC250	X7R (EIA)	0.47µF ±10%	4.5	3.2	2.0	2.2	0.3 min.
GRM55DR72E474KW01L	DC250	X7R (EIA)	0.47µF ±10%	5.7	5.0	2.0	3.2	0.3 min.
GRM55DR72E105KW01L	DC250	X7R (EIA)	1.0µF ±10%	5.7	5.0	2.0	3.2	0.3 min.
GRM31BR72J102KW01L	DC630	X7R (EIA)	1000pF ±10%	3.2	1.6	1.25	1.2	0.3 min.
GRM31BR72J152KW01L	DC630	X7R (EIA)	1500pF ±10%	3.2	1.6	1.25	1.2	0.3 min.

Continued on the following page.



 Continued from the preceding page.

Part Number	Rated Voltage (V)	TC Code (Standard)	Capacitance	Length L (mm)	Width W (mm)	Thickness T (mm)	Electrode g min. (mm)	Electrode e (mm)
GRM31BR72J222KW01L	DC630	X7R (EIA)	2200pF ±10%	3.2	1.6	1.25	1.2	0.3 min.
GRM31BR72J332KW01L	DC630	X7R (EIA)	3300pF ±10%	3.2	1.6	1.25	1.2	0.3 min.
GRM31BR72J472KW01L	DC630	X7R (EIA)	4700pF ±10%	3.2	1.6	1.25	1.2	0.3 min.
GRM31BR72J682KW01L	DC630	X7R (EIA)	6800pF ±10%	3.2	1.6	1.25	1.2	0.3 min.
GRM31BR72J103KW01L	DC630	X7R (EIA)	10000pF ±10%	3.2	1.6	1.25	1.2	0.3 min.
GRM31CR72J153KW03L	DC630	X7R (EIA)	15000pF ±10%	3.2	1.6	1.6	1.2	0.3 min.
GRM32QR72J223KW01L	DC630	X7R (EIA)	22000pF ±10%	3.2	2.5	1.5	1.2	0.3 min.
GRM32DR72J333KW01L	DC630	X7R (EIA)	33000pF ±10%	3.2	2.5	2.0	1.2	0.3 min.
GRM32DR72J473KW01L	DC630	X7R (EIA)	47000pF ±10%	3.2	2.5	2.0	1.2	0.3 min.
GRM43QR72J683KW01L	DC630	X7R (EIA)	68000pF ±10%	4.5	3.2	1.5	2.2	0.3 min.
GRM43DR72J104KW01L	DC630	X7R (EIA)	0.10μF ±10%	4.5	3.2	2.0	2.2	0.3 min.
GRM55DR72J154KW01L	DC630	X7R (EIA)	0.15μF ±10%	5.7	5.0	2.0	3.2	0.3 min.
GRM55DR72J224KW01L	DC630	X7R (EIA)	0.22μF ±10%	5.7	5.0	2.0	3.2	0.3 min.
GRM31BR73A102KW01L	DC1000	X7R (EIA)	1000pF ±10%	3.2	1.6	1.25	1.2	0.3 min.
GRM31BR73A152KW01L	DC1000	X7R (EIA)	1500pF ±10%	3.2	1.6	1.25	1.2	0.3 min.
GRM31BR73A222KW01L	DC1000	X7R (EIA)	2200pF ±10%	3.2	1.6	1.25	1.2	0.3 min.
GRM31BR73A332KW01L	DC1000	X7R (EIA)	3300pF ±10%	3.2	1.6	1.25	1.2	0.3 min.
GRM31BR73A472KW01L	DC1000	X7R (EIA)	4700pF ±10%	3.2	1.6	1.25	1.2	0.3 min.
GRM32QR73A682KW01L	DC1000	X7R (EIA)	6800pF ±10%	3.2	2.5	1.5	1.2	0.3 min.
GRM32QR73A103KW01L	DC1000	X7R (EIA)	10000pF ±10%	3.2	2.5	1.5	1.2	0.3 min.
GRM32DR73A153KW01L	DC1000	X7R (EIA)	15000pF ±10%	3.2	2.5	2.0	1.2	0.3 min.
GRM32DR73A223KW01L	DC1000	X7R (EIA)	22000pF ±10%	3.2	2.5	2.0	1.2	0.3 min.
GRM43DR73A333KW01L	DC1000	X7R (EIA)	33000pF ±10%	4.5	3.2	2.0	2.2	0.3 min.
GRM43DR73A473KW01L	DC1000	X7R (EIA)	47000pF ±10%	4.5	3.2	2.0	2.2	0.3 min.
GRM55DR73A104KW01L	DC1000	X7R (EIA)	0.10μF ±10%	5.7	5.0	2.0	3.2	0.3 min.

## Specifications and Test Methods

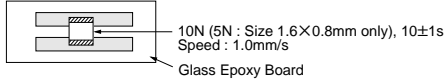
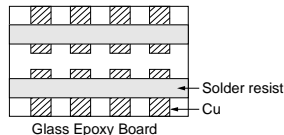
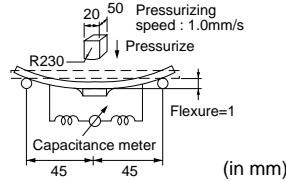
No.	Item	Specifications	Test Method
1	Operating Temperature Range	-55 to +125°C	-
2	Appearance	No defects or abnormalities	Visual inspection
3	Dimensions	Within the specified dimensions	Using calipers
4	Dielectric Strength	No defects or abnormalities	No failure should be observed when 150% of the rated voltage (200% of the rated voltage in case of rated voltage : DC250V, 120% of the rated voltage in case of rated voltage : DC1kV) is applied between the terminations for 1 to 5 sec., provided the charge/discharge current is less than 50mA.
5	Insulation Resistance (I.R.)	C ≥ 0.01μF : More than 100MΩ • μF C < 0.01μF : More than 10,000MΩ	The insulation resistance should be measured with DC500±50V (DC250±50V in case of rated voltage : DC250V) and within 60±5 sec. of charging.
6	Capacitance	Within the specified tolerance	The capacitance/D.F. should be measured at 25°C at a frequency of 1±0.2kHz and a voltage of AC1±0.2V(r.m.s.)
7	Dissipation Factor (D.F.)	0.025 max.	•Pretreatment Perform a heat treatment at 150 ± 0.5 °C for 60±5 min. and then let sit for 24±2 hrs. at *room condition.
8	Capacitance Temperature Characteristics	Cap. Change Within ±15% (Temp. Range : -55 to +125°C)	The range of capacitance change compared with the 25°C value within -55 to +125°C should be within the specified range. •Pretreatment Perform a heat treatment at 150 ± 0.5 °C for 60±5 min. and then let sit for 24±2 hrs. at *room condition.
9	Adhesive Strength of Termination	No removal of the terminations or other defect should occur.	Solder the capacitor to the testing jig (glass epoxy board) shown in Fig. 1 using a eutectic solder. Then apply 10N force in the direction of the arrow. The soldering should be done either with an iron or using the reflow method and should be conducted with care so that the soldering is uniform and free of defects such as heat shock. <div style="text-align: center;">  <p>10N (5N : Size 1.6×0.8mm only), 10±1s Speed : 1.0mm/s Glass Epoxy Board</p> </div> <p>Fig. 1</p>
10	Appearance	No defects or abnormalities	Solder the capacitor to the test jig (glass epoxy board). The capacitor should be subjected to a simple harmonic motion having a total amplitude of 1.5mm, the frequency being varied uniformly between the approximate limits of 10 and 55Hz. The frequency range, from 10 to 55Hz and return to 10Hz, should be traversed in approximately 1 min. This motion should be applied for a period of 2 hrs. in each 3 mutually perpendicular directions (total of 6 hrs.). <div style="text-align: center;">  <p>Solder resist Cu Glass Epoxy Board</p> </div>
	Capacitance	Within the specified tolerance	
	D.F.	0.025 max.	
11	Deflection	No cracking or marking defects should occur.	Solder the capacitor to the testing jig (glass epoxy board) shown in Fig. 2 using a eutectic solder. Then apply a force in the direction shown in Fig. 3. The soldering should be done either with an iron or using the reflow method and should be conducted with care so that the soldering is uniform and free of defects such as heat shock. <div style="text-align: center;">  <p>20 50 Pressurizing speed : 1.0mm/s Pressurize R230 Flexure=1 Capacitance meter 45 45 (in mm)</p> </div> <p>Fig. 3</p>

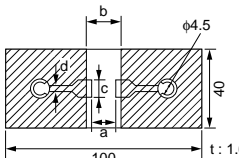

100 t: 1.6

L×W (mm)	Dimension (mm)			
	a	b	c	d
1.6×0.8	1.0	3.0	1.2	1.0
2.0×1.25	1.2	4.0	1.65	
3.2×1.6	2.2	5.0	2.0	
3.2×2.5	2.2	5.0	2.9	
4.5×3.2	3.5	7.0	3.7	
5.7×5.0	4.5	8.0	5.6	

Fig. 2

\* "Room condition" Temperature : 15 to 35°C, Relative humidity : 45 to 75%, Atmospheric pressure : 86 to 106kPa

Continued on the following page.

## Specifications and Test Methods

Continued from the preceding page.

No.	Item	Specifications	Test Method	
12	Solderability of Termination	75% of the terminations are to be soldered evenly and continuously.	Immerse the capacitor in a solution of ethanol (JIS-K-8101) and rosin (JIS-K-5902) (25% rosin in weight proportion). Immerse in solder solution for 2±0.5 sec. Immersing speed : 25±2.5mm/s Temp. of solder : 245±5°C Lead Free Solder (Sn-3.0Ag-0.5Cu) 235±5°C H60A or H63A Eutectic Solder	
13	Resistance to Soldering Heat	Appearance	Preheat the capacitor at 120 to 150°C* for 1 min. Immerse the capacitor in solder solution at 260±5°C for 10±1 sec. Let sit at *room condition for 24±2 hrs., then measure. •Immersing speed : 25±2.5mm/s •Pretreatment Perform a heat treatment at 150 ± <sub>1</sub> 8 °C for 60±5 min. and then let sit for 24±2 hrs. at *room condition.  *Preheating for more than 3.2X2.5mm	
		Capacitance Change		Within ±10%
		D.F.		0.025 max.
		I.R.		C≥0.01μF : More than 100MΩ • μF C<0.01μF : More than 10,000MΩ
		Dielectric Strength		In accordance with item No.4
14	Temperature Cycle	Appearance	Fix the capacitor to the supporting jig (glass epoxy board) shown in Fig. 4 using a eutectic solder. Perform the 5 cycles according to the 4 heat treatments listed in the following table. Let sit for 24±2 hrs. at *room condition, then measure.	
		Capacitance Change		Within ±7.5%
		D.F.		0.025 max.
		I.R.		C≥0.01μF : More than 100MΩ • μF C<0.01μF : More than 10,000MΩ
		Dielectric Strength		In accordance with item No.4
15	Humidity (Steady State)	Appearance	Let the capacitor sit at 40±2°C and relative humidity of 90 to 95% for 500 ± <sub>2</sub> 4 hrs. Remove and let sit for 24±2 hrs. at *room condition, then measure. •Pretreatment Perform a heat treatment at 150 ± <sub>1</sub> 8 °C for 60±5 min. and then let sit for 24±2 hrs. at *room condition.	
		Capacitance Change		Within ±15%
		D.F.		0.05 max.
		I.R.		C≥0.01μF : More than 10MΩ • μF C<0.01μF : More than 1,000MΩ
		Dielectric Strength		In accordance with item No.4
16	Life	Appearance	Apply 120% of the rated voltage (150% of the rated voltage in case of rated voltage : DC250V, 110% of the rated voltage in case of rated voltage : DC1kV) for 1,000 ± <sub>4</sub> 8 hrs. at maximum operating temperature ±3°C. Remove and let sit for 24 ±2 hrs. at *room condition, then measure. The charge/discharge current is less than 50mA. •Pretreatment Apply test voltage for 60±5 min. at test temperature. Remove and let sit for 24±2 hrs. at *room condition.	
		Capacitance Change		Within ±15% (rated voltage : DC250V, DC630V) Within ±20% (rated voltage : DC1kV)
		D.F.		0.05 max.
		I.R.		C≥0.01μF : More than 10MΩ • μF C<0.01μF : More than 1,000MΩ
		Dielectric Strength		In accordance with item No.4
17	Humidity Loading (Application : DC250V, DC630V item)	Appearance	Apply the rated voltage at 40±2°C and relative humidity of 90 to 95% for 500 ± <sub>2</sub> 4 hrs. Remove and let sit for 24±2 hrs. at *room condition, then measure. •Pretreatment Apply test voltage for 60±5 min. at test temperature. Remove and let sit for 24±2 hrs. at *room condition.	
		Capacitance Change		Within ±15%
		D.F.		0.05 max.
		I.R.		C≥0.01μF : More than 10MΩ • μF C<0.01μF : More than 1,000MΩ
		Dielectric Strength		In accordance with item No.4

Step	Temperature	Time
1	100 to 120°C	1 min.
2	170 to 200°C	1 min.

Step	Temperature (°C)	Time (min.)
1	Min. Operating Temp.±3	30±3
2	Room Temp.	2 to 3
3	Max. Operating Temp.±2	30±3
4	Room Temp.	2 to 3

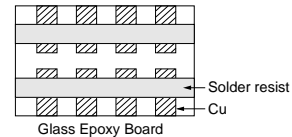

Fig. 4

\* "Room condition" Temperature : 15 to 35°C, Relative humidity : 45 to 75%, Atmospheric pressure : 86 to 106kPa

# Chip Monolithic Ceramic Capacitors



## Only for Information Devices/Tip & Ring

### ■ Features

1. These items are designed specifically for telecommunication devices (IEEE802.3) in Ethernet LAN.
2. A new monolithic structure for small, high capacitance capable of operating at high voltage levels.
3. Sn-plated external electrodes realizes good solderability.
4. Only for reflow soldering
5. The low-profile type (thickness: 1.5mm max.) is available. Fit for use on thinner type equipment.

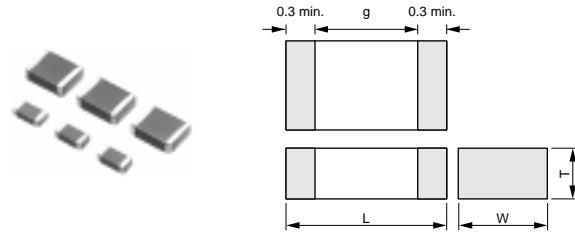

Part Number	Dimensions (mm)			
	L	W	T	g min.
GR442Q	4.5 ±0.3	2.0 ±0.2	1.5 +0, -0.3	2.5
GR443D	4.5 ±0.4	3.2 ±0.3	2.0 +0, -0.3	
GR443Q			1.5 +0, -0.3	

### ■ Applications

Ideal for use on telecommunication devices in Ethernet LAN

Part Number	Rated Voltage (V)	TC Code (Standard)	Capacitance (pF)	Length L (mm)	Width W (mm)	Thickness T (mm)	Electrode g min. (mm)	Electrode e (mm)
GR442QR73D101KW01L	DC2000	X7R (EIA)	100 ±10%	4.5	2.0	1.5	2.5	0.3 min.
GR442QR73D121KW01L	DC2000	X7R (EIA)	120 ±10%	4.5	2.0	1.5	2.5	0.3 min.
GR442QR73D151KW01L	DC2000	X7R (EIA)	150 ±10%	4.5	2.0	1.5	2.5	0.3 min.
GR442QR73D181KW01L	DC2000	X7R (EIA)	180 ±10%	4.5	2.0	1.5	2.5	0.3 min.
GR442QR73D221KW01L	DC2000	X7R (EIA)	220 ±10%	4.5	2.0	1.5	2.5	0.3 min.
GR442QR73D271KW01L	DC2000	X7R (EIA)	270 ±10%	4.5	2.0	1.5	2.5	0.3 min.
GR442QR73D331KW01L	DC2000	X7R (EIA)	330 ±10%	4.5	2.0	1.5	2.5	0.3 min.
GR442QR73D391KW01L	DC2000	X7R (EIA)	390 ±10%	4.5	2.0	1.5	2.5	0.3 min.
GR442QR73D471KW01L	DC2000	X7R (EIA)	470 ±10%	4.5	2.0	1.5	2.5	0.3 min.
GR442QR73D561KW01L	DC2000	X7R (EIA)	560 ±10%	4.5	2.0	1.5	2.5	0.3 min.
GR442QR73D681KW01L	DC2000	X7R (EIA)	680 ±10%	4.5	2.0	1.5	2.5	0.3 min.
GR442QR73D821KW01L	DC2000	X7R (EIA)	820 ±10%	4.5	2.0	1.5	2.5	0.3 min.
GR442QR73D102KW01L	DC2000	X7R (EIA)	1000 ±10%	4.5	2.0	1.5	2.5	0.3 min.
GR442QR73D122KW01L	DC2000	X7R (EIA)	1200 ±10%	4.5	2.0	1.5	2.5	0.3 min.
GR442QR73D152KW01L	DC2000	X7R (EIA)	1500 ±10%	4.5	2.0	1.5	2.5	0.3 min.
GR443QR73D182KW01L	DC2000	X7R (EIA)	1800 ±10%	4.5	3.2	1.5	2.5	0.3 min.
GR443QR73D222KW01L	DC2000	X7R (EIA)	2200 ±10%	4.5	3.2	1.5	2.5	0.3 min.
GR443QR73D272KW01L	DC2000	X7R (EIA)	2700 ±10%	4.5	3.2	1.5	2.5	0.3 min.
GR443QR73D332KW01L	DC2000	X7R (EIA)	3300 ±10%	4.5	3.2	1.5	2.5	0.3 min.
GR443QR73D392KW01L	DC2000	X7R (EIA)	3900 ±10%	4.5	3.2	1.5	2.5	0.3 min.
GR443DR73D472KW01L	DC2000	X7R (EIA)	4700 ±10%	4.5	3.2	2.0	2.5	0.3 min.

## Specifications and Test Methods

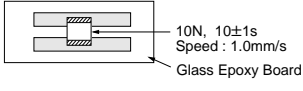
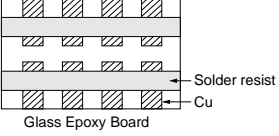
No.	Item	Specifications	Test Method								
1	Operating Temperature Range	-55 to +125°C	—								
2	Appearance	No defects or abnormalities	Visual inspection								
3	Dimensions	Within the specified dimensions	Using calipers								
4	Dielectric Strength	No defects or abnormalities	<p>No failure should be observed when voltage in table is applied between the terminations, provided the charge/discharge current is less than 50mA.</p> <table border="1" style="width: 100%; border-collapse: collapse;"> <thead> <tr> <th>Rated voltage</th> <th>Test Voltage</th> <th>Time</th> </tr> </thead> <tbody> <tr> <td rowspan="2" style="text-align: center;">DC2kV</td> <td style="text-align: center;">120% of the rated voltage</td> <td style="text-align: center;">60±1 sec.</td> </tr> <tr> <td style="text-align: center;">AC1500V(r.m.s.)</td> <td style="text-align: center;">60±1 sec.</td> </tr> </tbody> </table>	Rated voltage	Test Voltage	Time	DC2kV	120% of the rated voltage	60±1 sec.	AC1500V(r.m.s.)	60±1 sec.
Rated voltage	Test Voltage	Time									
DC2kV	120% of the rated voltage	60±1 sec.									
	AC1500V(r.m.s.)	60±1 sec.									
5	Pulse Voltage	No self healing break downs or flash-overs have taken place in the capacitor.	<p>10 impulse of alternating polarity is subjected. (5 impulse for each polarity) The interval between impulse is 60 sec. Applied Voltage : 2.5kV zero to peak</p>								
6	Insulation Resistance (I.R.)	More than 6,000MΩ	The insulation resistance should be measured with DC500±50V and within 60±5 sec. of charging.								
7	Capacitance	Within the specified tolerance	The capacitance/D.F. should be measured at 25°C at a frequency of 1±0.2kHz and a voltage of AC1±0.2V(r.m.s.)								
8	Dissipation Factor (D.F.)	0.025 max.	<p>•Pretreatment Perform a heat treatment at 150 ± 0 °C for 60±5 min. and then let sit for 24±2 hrs. at *room condition.</p>								
9	Capacitance Temperature Characteristics	Cap. Change within ±15% (Temp. Range : -55 to +125°C)	<p>The range of capacitance change compared with the 25°C value within the specified range. •Pretreatment Perform a heat treatment at 150 ± 0 °C for 60±5 min. and then let sit for 24±2 hrs. at *room condition.</p>								
10	Adhesive Strength of Termination	No removal of the terminations or other defect should occur.	<p>Solder the capacitor to the testing jig (glass epoxy board) shown in Fig. 1 using a eutectic solder. Then apply 10N force in the direction of the arrow. The soldering should be done either with an iron or using the reflow method and should be conducted with care so that the soldering is uniform and free of defects such as heat shock.</p> <div style="text-align: center;">  <p>10N, 10±1s Speed : 1.0mm/s Glass Epoxy Board</p> </div> <p style="text-align: center;">Fig. 1</p>								
11	Vibration Resistance	Appearance	No defects or abnormalities								
		Capacitance	Within the specified tolerance								
		D.F.	0.025 max.								
			<p>Solder the capacitor to the test jig (glass epoxy board). The capacitor should be subjected to a simple harmonic motion having a total amplitude of 1.5mm, the frequency being varied uniformly between the approximate limits of 10 and 55Hz. The frequency range, from 10 to 55Hz and return to 10Hz, should be traversed in approximately 1 min. This motion should be applied for a period of 2 hrs. in each 3 mutually perpendicular directions (total of 6 hrs.).</p> <div style="text-align: center;">  <p>Solder resist Cu Glass Epoxy Board</p> </div>								

\* "Room condition" Temperature : 15 to 35°C, Relative humidity : 45 to 75%, Atmospheric pressure : 86 to 106kPa

Continued on the following page.

## Specifications and Test Methods

Continued from the preceding page.

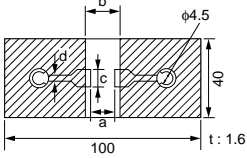
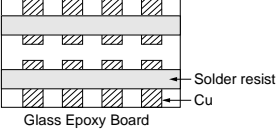
No.	Item	Specifications	Test Method															
12	Deflection	No cracking or marking defects should occur.	Solder the capacitor to the testing jig (glass epoxy board) shown in Fig. 2 using a eutectic solder. Then apply a force in the direction shown in Fig. 3. The soldering should be done either with an iron or using the reflow method and should be conducted with care so that the soldering is uniform and free of defects such as heat shock.															
		 <table border="1" data-bbox="375 488 885 593"> <thead> <tr> <th rowspan="2">L×W (mm)</th> <th colspan="4">Dimension (mm)</th> </tr> <tr> <th>a</th> <th>b</th> <th>c</th> <th>d</th> </tr> </thead> <tbody> <tr> <td>4.5×2.0</td> <td>3.5</td> <td>7.0</td> <td>2.4</td> <td rowspan="2">1.0</td> </tr> <tr> <td>4.5×3.2</td> <td>3.5</td> <td>7.0</td> <td>3.7</td> </tr> </tbody> </table> <p>Fig. 2</p>		L×W (mm)	Dimension (mm)				a	b	c	d	4.5×2.0	3.5	7.0	2.4	1.0	4.5×3.2
L×W (mm)	Dimension (mm)																	
	a	b	c	d														
4.5×2.0	3.5	7.0	2.4	1.0														
4.5×3.2	3.5	7.0	3.7															
13	Solderability of Termination	75% of the terminations are to be soldered evenly and continuously.	Immerse the capacitor in a solution of ethanol (JIS-K-8101) and rosin (JIS-K-5902) (25% rosin in weight proportion). Immerse in solder solution for 2±0.5 sec. Immersing speed : 25±2.5mm/s Temp. of solder : 245±5°C Lead Free Solder (Sn-3.0Ag-0.5Cu) 235±5°C H60A or H63A Eutectic Solder															
14	Resistance to Soldering Heat	Appearance	No marking defects															
		Capacitance Change	Within ±10%															
		D.F.	0.025 max.															
		I.R.	More than 1,000MΩ															
	Dielectric Strength	In accordance with item No.4																
15	Temperature Cycle	Appearance	No marking defects															
		Capacitance Change	Within ±15%															
		D.F.	0.05 max.															
		I.R.	More than 3,000MΩ															
		Dielectric Strength	In accordance with item No.4															
		Preheat the capacitor as table. Immerse the capacitor in solder solution at 260±5°C for 10±1 sec. Let sit at *room condition for 24±2 hrs., then measure. •Immersing speed : 25±2.5mm/s •Pretreatment Perform a heat treatment at 150±18°C for 60±5 min. and then let sit for 24±2 hrs. at *room condition.																
		*Preheating																
		<table border="1" data-bbox="941 1070 1452 1146"> <thead> <tr> <th>Step</th> <th>Temperature</th> <th>Time</th> </tr> </thead> <tbody> <tr> <td>1</td> <td>100 to 120°C</td> <td>1 min.</td> </tr> <tr> <td>2</td> <td>170 to 200°C</td> <td>1 min.</td> </tr> </tbody> </table>	Step	Temperature	Time	1	100 to 120°C	1 min.	2	170 to 200°C	1 min.							
Step	Temperature	Time																
1	100 to 120°C	1 min.																
2	170 to 200°C	1 min.																
		Fix the capacitor to the supporting jig (glass epoxy board) shown in Fig. 4 using a eutectic solder. Perform the 5 cycles according to the 4 heat treatments listed in the following table. Let sit for 24±2 hrs. at *room condition, then measure.																
		<table border="1" data-bbox="941 1294 1452 1422"> <thead> <tr> <th>Step</th> <th>Temperature (°C)</th> <th>Time (min.)</th> </tr> </thead> <tbody> <tr> <td>1</td> <td>Min. Operating Temp.±3</td> <td>30±3</td> </tr> <tr> <td>2</td> <td>Room Temp.</td> <td>2 to 3</td> </tr> <tr> <td>3</td> <td>Max. Operating Temp.±2</td> <td>30±3</td> </tr> <tr> <td>4</td> <td>Room Temp.</td> <td>2 to 3</td> </tr> </tbody> </table>	Step	Temperature (°C)	Time (min.)	1	Min. Operating Temp.±3	30±3	2	Room Temp.	2 to 3	3	Max. Operating Temp.±2	30±3	4	Room Temp.	2 to 3	
Step	Temperature (°C)	Time (min.)																
1	Min. Operating Temp.±3	30±3																
2	Room Temp.	2 to 3																
3	Max. Operating Temp.±2	30±3																
4	Room Temp.	2 to 3																
		•Pretreatment Perform a heat treatment at 150±18°C for 60±5 min. and then let sit for 24±2 hrs. at *room condition.																
		 <p>Fig. 4</p>																
16	Humidity (Steady State)	Appearance	No marking defects															
		Capacitance Change	Within ±15%															
		D.F.	0.05 max.															
		I.R.	More than 1,000MΩ															
		Dielectric Strength	In accordance with item No.4															
		Let the capacitor sit at 40±2°C and relative humidity of 90 to 95% for 500±24 hrs. Remove and let sit for 24±2 hrs. at *room condition, then measure. •Pretreatment Perform a heat treatment at 150±18°C for 60±5 min. and then let sit for 24±2 hrs. at *room condition.																

\* "Room condition" Temperature : 15 to 35°C, Relative humidity : 45 to 75%, Atmospheric pressure : 86 to 106kPa

Continued on the following page. 

## Specifications and Test Methods

☐ Continued from the preceding page.

No.	Item	Specifications	Test Method
17	Appearance	No marking defects	Apply 110% of the rated voltage for 1,000 <sup>±48</sup> hrs. at maximum operating temperature ±3°C. Remove and let sit for 24 ±2 hrs. at *room condition, then measure. The charge/discharge current is less than 50mA. •Pretreatment Apply test voltage for 60±5 min. at test temperature. Remove and let sit for 24±2 hrs. at *room condition.
	Capacitance Change	Within ±20%	
	D.F.	0.05 max.	
	I.R.	More than 2,000MΩ	
	Dielectric Strength	In accordance with item No.4	

\* "Room condition" Temperature : 15 to 35°C, Relative humidity : 45 to 75%, Atmospheric pressure : 86 to 106kPa

# Chip Monolithic Ceramic Capacitors



## Only for Camera Flash Circuit

### ■ Features

1. Suitable for the trigger of the flash circuit, because real capacitance is stable during operating voltage.
2. The thin type fit for thinner camera.
3. Sn-plated external electrodes realizes good solderability.
4. For flow and reflow soldering

### ■ Applications

For strobe circuit

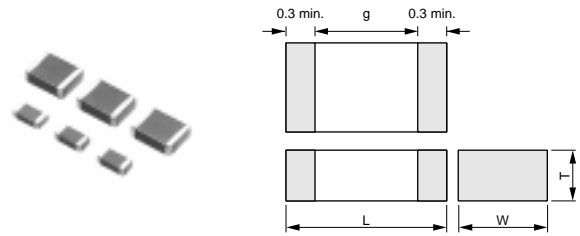

Part Number	Dimensions (mm)			
	L	W	T	g min.
<b>GR731A</b>	3.2 ±0.2	1.6 ±0.2	1.0 +0, -0.3	1.2
<b>GR731B</b>			1.25 +0, -0.3	
<b>GR731C</b>			1.6 ±0.2	

Part Number	Rated Voltage (V)	TC Code (Standard)	Capacitance (pF)	Length L (mm)	Width W (mm)	Thickness T (mm)	Electrode g min. (mm)	Electrode e (mm)
<b>GR731AW0BB103KW01D</b>	DC350	-	10000 ±10%	3.2	1.6	1.0	1.2	0.3 min.
<b>GR731AW0BB153KW01D</b>	DC350	-	15000 ±10%	3.2	1.6	1.0	1.2	0.3 min.
<b>GR731BW0BB223KW01L</b>	DC350	-	22000 ±10%	3.2	1.6	1.25	1.2	0.3 min.
<b>GR731BW0BB333KW01L</b>	DC350	-	33000 ±10%	3.2	1.6	1.25	1.2	0.3 min.
<b>GR731CW0BB473KW03L</b>	DC350	-	47000 ±10%	3.2	1.6	1.6	1.2	0.3 min.

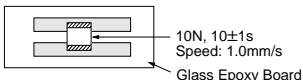
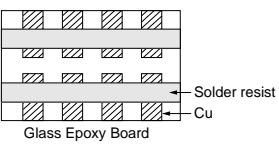
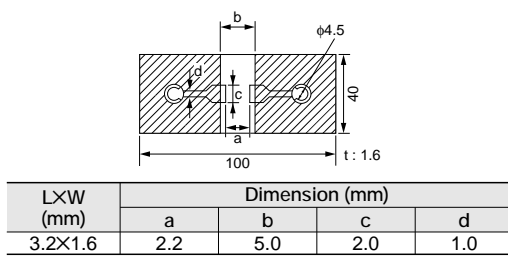
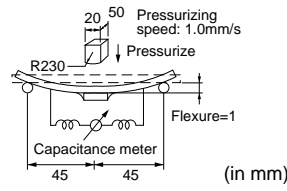

## Specifications and Test Methods

No.	Item	Specifications	Test Method														
1	Operating Temperature Range	-55 to +125°C	—														
2	Appearance	No defects or abnormalities	Visual inspection														
3	Dimensions	Within the specified dimensions	Using calipers														
4	Dielectric Strength	No defects or abnormalities	No failure should be observed when DC500V is applied between the terminations for 1 to 5 sec., provided the charge/discharge current is less than 50mA.														
5	Insulation Resistance (I.R.)	C ≥ 0.01 μF: More than 100MΩ • μF C < 0.01 μF: More than 10,000MΩ	The insulation resistance should be measured with DC250±50V and within 60±5 sec. of charging.														
6	Capacitance	Within the specified tolerance	The capacitance/D.F. should be measured at 25°C at a frequency of 1±0.2kHz and a voltage of AC1±0.2V(r.m.s.) •Pretreatment														
7	Dissipation Factor (D.F.)	0.025 max.	Perform a heat treatment at 150 ± 0 °C for 60±5 min. and then let sit for 24±2 hrs. at *room condition.														
8	Capacitance Temperature Characteristics	Cap. Change Within ±10% (Apply DC350V bias) Within ±2.5% (No DC bias)	The range of capacitance change compared with the 25°C value within -55 to +125°C should be within the specified range. •Pretreatment Perform a heat treatment at 150 ± 0 °C for 60±5 min. and then let sit for 24±2 hrs. at *room condition.														
9	Adhesive Strength of Termination	No removal of the terminations or other defect should occur.	Solder the capacitor to the testing jig (glass epoxy board) shown in Fig. 1 using a eutectic solder. Then apply 10N force in the direction of the arrow. The soldering should be done either with an iron or using the reflow method and should be conducted with care so that the soldering is uniform and free of defects such as heat shock.   <p style="text-align: center;">Fig. 1</p>														
10	Appearance	No defects or abnormalities	Solder the capacitor to the test jig (glass epoxy board). The capacitor should be subjected to a simple harmonic motion having a total amplitude of 1.5mm, the frequency being varied uniformly between the approximate limits of 10 and 55Hz. The frequency range, from 10 to 55Hz and return to 10Hz, should be traversed in approximately 1 min. This motion should be applied for a period of 2 hrs. in each 3 mutually perpendicular directions (total of 6 hrs.).   <p style="text-align: center;">Glass Epoxy Board</p>														
	Capacitance	Within the specified tolerance															
	D.F.	0.025 max.															
11	Deflection	No cracking or marking defects should occur.   <table border="1" style="margin-left: auto; margin-right: auto;"> <thead> <tr> <th rowspan="2">L×W (mm)</th> <th colspan="4">Dimension (mm)</th> </tr> <tr> <th>a</th> <th>b</th> <th>c</th> <th>d</th> </tr> </thead> <tbody> <tr> <td>3.2×1.6</td> <td>2.2</td> <td>5.0</td> <td>2.0</td> <td>1.0</td> </tr> </tbody> </table> <p style="text-align: center;">Fig. 2</p>	L×W (mm)	Dimension (mm)				a	b	c	d	3.2×1.6	2.2	5.0	2.0	1.0	Solder the capacitor to the testing jig (glass epoxy board) shown in Fig. 2 using a eutectic solder. Then apply a force in the direction shown in Fig. 3. The soldering should be done either with an iron or using the reflow method and should be conducted with care so that the soldering is uniform and free of defects such as heat shock.   <p style="text-align: center;">(in mm)</p> <p style="text-align: center;">Fig. 3</p>
L×W (mm)	Dimension (mm)																
	a	b	c	d													
3.2×1.6	2.2	5.0	2.0	1.0													
12	Solderability of Termination	75% of the terminations are to be soldered evenly and continuously.	Immerse the capacitor in a solution of ethanol (JIS-K-8101) and rosin (JIS-K-5902) (25% rosin in weight proportion). Immerse in solder solution for 2±0.5 sec. Immersing speed: 25±2.5mm/s Temp. of solder : 245±5°C Lead Free Solder (Sn-3.0Ag-0.5Cu) 235±5°C H60A or H63A Eutectic Solder														

\* "Room condition" Temperature: 15 to 35°C, Relative humidity: 45 to 75%, Atmospheric pressure: 86 to 106kPa

## Specifications and Test Methods

Continued from the preceding page.

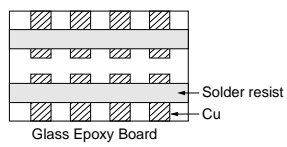
No.	Item	Specifications	Test Method															
13	Resistance to Soldering Heat	Appearance	No marking defects															
		Capacitance Change	Within $\pm 10\%$															
		D.F.	0.025 max.															
		I.R.	$C \geq 0.01\mu\text{F}$ : More than $100\text{M}\Omega \cdot \mu\text{F}$ $C < 0.01\mu\text{F}$ : More than $10,000\text{M}\Omega$															
		Dielectric Strength	In accordance with item No.4															
			Preheat the capacitor at $120$ to $150^\circ\text{C}^*$ for 1 min. Immerse the capacitor in solder solution at $260 \pm 5^\circ\text{C}$ for $10 \pm 1$ sec. Let sit at *room condition for $24 \pm 2$ hrs., then measure. •Immersing speed : $25 \pm 2.5\text{mm/s}$ •Pretreatment Perform a heat treatment at $150 \pm 1.8^\circ\text{C}$ for $60 \pm 5$ min. and then let sit for $24 \pm 2$ hrs. at *room condition.  *Preheating for more than $3.2 \times 2.5\text{mm}$ <table border="1" style="margin-left: auto; margin-right: auto;"> <thead> <tr> <th>Step</th> <th>Temperature</th> <th>Time</th> </tr> </thead> <tbody> <tr> <td>1</td> <td>100 to <math>120^\circ\text{C}</math></td> <td>1 min.</td> </tr> <tr> <td>2</td> <td>170 to <math>200^\circ\text{C}</math></td> <td>1 min.</td> </tr> </tbody> </table>	Step	Temperature	Time	1	100 to $120^\circ\text{C}$	1 min.	2	170 to $200^\circ\text{C}$	1 min.						
Step	Temperature	Time																
1	100 to $120^\circ\text{C}$	1 min.																
2	170 to $200^\circ\text{C}$	1 min.																
14	Temperature Cycle	Appearance	No marking defects															
		Capacitance Change	Within $\pm 7.5\%$															
		D.F.	0.025 max.															
		I.R.	$C \geq 0.01\mu\text{F}$ : More than $100\text{M}\Omega \cdot \mu\text{F}$ $C < 0.01\mu\text{F}$ : More than $10,000\text{M}\Omega$															
		Dielectric Strength	In accordance with item No.4															
			Fix the capacitor to the supporting jig (glass epoxy board) shown in Fig. 4 using a eutectic solder. Perform the 5 cycles according to the 4 heat treatments listed in the following table. Let sit for $24 \pm 2$ hrs. at *room condition, then measure. <table border="1" style="margin-left: auto; margin-right: auto;"> <thead> <tr> <th>Step</th> <th>Temperature (<math>^\circ\text{C}</math>)</th> <th>Time (min.)</th> </tr> </thead> <tbody> <tr> <td>1</td> <td>Min. Operating Temp. <math>\pm 3</math></td> <td><math>30 \pm 3</math></td> </tr> <tr> <td>2</td> <td>Room Temp.</td> <td>2 to 3</td> </tr> <tr> <td>3</td> <td>Max. Operating Temp. <math>\pm 2</math></td> <td><math>30 \pm 3</math></td> </tr> <tr> <td>4</td> <td>Room Temp.</td> <td>2 to 3</td> </tr> </tbody> </table> •Pretreatment Perform a heat treatment at $150 \pm 1.8^\circ\text{C}$ for $60 \pm 5$ min. and then let sit for $24 \pm 2$ hrs. at *room condition.	Step	Temperature ( $^\circ\text{C}$ )	Time (min.)	1	Min. Operating Temp. $\pm 3$	$30 \pm 3$	2	Room Temp.	2 to 3	3	Max. Operating Temp. $\pm 2$	$30 \pm 3$	4	Room Temp.	2 to 3
Step	Temperature ( $^\circ\text{C}$ )	Time (min.)																
1	Min. Operating Temp. $\pm 3$	$30 \pm 3$																
2	Room Temp.	2 to 3																
3	Max. Operating Temp. $\pm 2$	$30 \pm 3$																
4	Room Temp.	2 to 3																
			 <p style="text-align: center;">Fig. 4</p>															
15	Humidity (Steady State)	Appearance	No marking defects															
		Capacitance Change	Within $\pm 15\%$															
		D.F.	0.05 max.															
		I.R.	$C \geq 0.01\mu\text{F}$ : More than $10\text{M}\Omega \cdot \mu\text{F}$ $C < 0.01\mu\text{F}$ : More than $1,000\text{M}\Omega$															
		Dielectric Strength	In accordance with item No.4															
			Let the capacitor sit at $40 \pm 2^\circ\text{C}$ and relative humidity of 90 to 95% for $500 \pm 24$ hrs. Remove and let sit for $24 \pm 2$ hrs. at *room condition, then measure. •Pretreatment Perform a heat treatment at $150 \pm 1.8^\circ\text{C}$ for $60 \pm 5$ min. and then let sit for $24 \pm 2$ hrs. at *room condition.															
16	Life	Appearance	No marking defects															
		Capacitance Change	Within $\pm 15\%$															
		D.F.	0.05 max.															
		I.R.	$C \geq 0.01\mu\text{F}$ : More than $10\text{M}\Omega \cdot \mu\text{F}$ $C < 0.01\mu\text{F}$ : More than $1,000\text{M}\Omega$															
		Dielectric Strength	In accordance with item No.4															
			Apply DC350V for $1,000 \pm 48$ hrs. at maximum operating temperature $\pm 3^\circ\text{C}$ . Remove and let sit for $24 \pm 2$ hrs. at *room condition, then measure. The charge/discharge current is less than 50mA. •Pretreatment Apply test voltage for $60 \pm 5$ min. at test temperature. Remove and let sit for $24 \pm 2$ hrs. at *room condition.															
17	Humidity Loading	Appearance	No marking defects															
		Capacitance Change	Within $\pm 15\%$															
		D.F.	0.05 max.															
		I.R.	$C \geq 0.01\mu\text{F}$ : More than $10\text{M}\Omega \cdot \mu\text{F}$ $C < 0.01\mu\text{F}$ : More than $1,000\text{M}\Omega$															
		Dielectric Strength	In accordance with item No.4															
			Apply the rated voltage at $40 \pm 2^\circ\text{C}$ and relative humidity of 90 to 95% for $500 \pm 24$ hrs. Remove and let sit for $24 \pm 2$ hrs. at *room condition, then measure. •Pretreatment Apply test voltage for $60 \pm 5$ min. at test temperature. Remove and let sit for $24 \pm 2$ hrs. at *room condition.															

\* "Room condition" Temperature:  $15$  to  $35^\circ\text{C}$ , Relative humidity: 45 to 75%, Atmospheric pressure: 86 to  $106\text{kPa}$

# Chip Monolithic Ceramic Capacitors



## AC250V(r.m.s.) Type (Which Meet Japanese Law)

### ■ Features

1. Chip monolithic ceramic capacitor for AC lines.
2. A new monolithic structure for small, high capacitance capable of operating at high voltage levels.
3. Sn-plated external electrodes realizes good solderability.
4. Only for reflow soldering
5. Capacitance 0.01 to 0.1uF for connecting lines and 470 to 4700pF for connecting lines to earth.

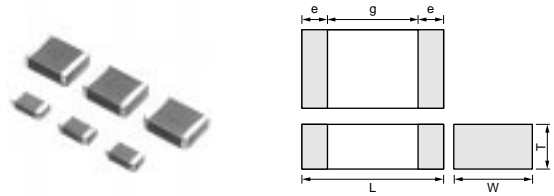

Part Number	Dimensions (mm)				
	L	W	T	e min.	g min.
<b>GA242Q</b>	4.5 ±0.3	2.0 ±0.2	1.5 +0, -0.3	0.3	2.5
<b>GA243D</b>	4.5 ±0.4	3.2 ±0.3	2.0 +0, -0.3		
<b>GA243Q</b>			1.5 +0, -0.3		3.2
<b>GA255D</b>	5.7 ±0.4	5.0 ±0.4	2.0 +0, -0.3		

### ■ Applications

Noise suppression filters for switching power supplies, telephones, facsimiles, modems.

### ■ Reference standard

GA2 series obtains no safety approval.  
 This series is based on JIS C 5102, JIS C 5150, and the standards of the electrical appliance and material safety law of Japan (separated table 4).

Part Number	Rated Voltage (V)	TC Code (Standard)	Capacitance	Length L (mm)	Width W (mm)	Thickness T (mm)	Electrode g min. (mm)	Electrode e (mm)
<b>GA242QR7E2471MW01L</b>	AC250 (r.m.s.)	X7R (EIA)	470pF ±20%	4.5	2.0	1.5	2.5	0.3 min.
<b>GA242QR7E2102MW01L</b>	AC250 (r.m.s.)	X7R (EIA)	1000pF ±20%	4.5	2.0	1.5	2.5	0.3 min.
<b>GA243QR7E2222MW01L</b>	AC250 (r.m.s.)	X7R (EIA)	2200pF ±20%	4.5	3.2	1.5	2.5	0.3 min.
<b>GA243QR7E2332MW01L</b>	AC250 (r.m.s.)	X7R (EIA)	3300pF ±20%	4.5	3.2	1.5	2.5	0.3 min.
<b>GA243DR7E2472MW01L</b>	AC250 (r.m.s.)	X7R (EIA)	4700pF ±20%	4.5	3.2	2.0	2.5	0.3 min.
<b>GA243QR7E2103MW01L</b>	AC250 (r.m.s.)	X7R (EIA)	10000pF ±20%	4.5	3.2	1.5	2.5	0.3 min.
<b>GA243QR7E2223MW01L</b>	AC250 (r.m.s.)	X7R (EIA)	22000pF ±20%	4.5	3.2	1.5	2.5	0.3 min.
<b>GA243DR7E2473MW01L</b>	AC250 (r.m.s.)	X7R (EIA)	47000pF ±20%	4.5	3.2	2.0	2.5	0.3 min.
<b>GA255DR7E2104MW01L</b>	AC250 (r.m.s.)	X7R (EIA)	0.10uF ±20%	5.7	5.0	2.0	3.2	0.3 min.

## Specifications and Test Methods

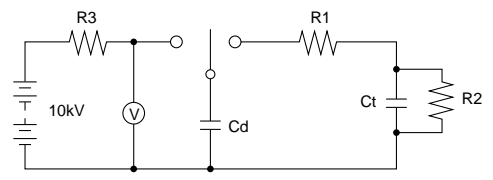
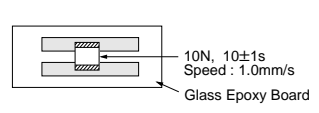
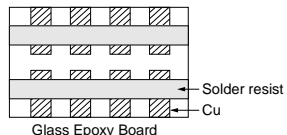
No.	Item	Specifications	Test Method						
1	Operating Temperature Range	-55 to +125°C	—						
2	Appearance	No defects or abnormalities	Visual inspection						
3	Dimensions	Within the specified dimensions	Using calipers						
4	Dielectric Strength	No defects or abnormalities	No failure should be observed when voltage in table is applied between the terminations for 60±1 sec., provided the charge/discharge current is less than 50mA. <table border="1" style="margin-left: auto; margin-right: auto;"> <thead> <tr> <th>Nominal Capacitance</th> <th>Test voltage</th> </tr> </thead> <tbody> <tr> <td>C≥10,000pF</td> <td>AC575V(r.m.s.)</td> </tr> <tr> <td>C&lt;10,000pF</td> <td>AC1500V(r.m.s.)</td> </tr> </tbody> </table>	Nominal Capacitance	Test voltage	C≥10,000pF	AC575V(r.m.s.)	C<10,000pF	AC1500V(r.m.s.)
Nominal Capacitance	Test voltage								
C≥10,000pF	AC575V(r.m.s.)								
C<10,000pF	AC1500V(r.m.s.)								
5	Insulation Resistance (I.R.)	More than 2,000MΩ	The insulation resistance should be measured with DC500±50V and within 60±5 sec. of charging.						
6	Capacitance	Within the specified tolerance	The capacitance/D.F. should be measured at 25°C at a frequency of 1±0.2kHz and a voltage of AC1±0.2V(r.m.s.)						
7	Dissipation Factor (D.F.)	0.025 max.	•Pretreatment Perform a heat treatment at 150±1.8°C for 60±5 min. and then let sit for 24±2 hrs. at *room condition.						
8	Capacitance Temperature Characteristics	Cap. Change Within ±15% (Temp. Range : -55 to +125°C)	The range of capacitance change compared with the 25°C value within -55 to +125°C should be within the specified range. •Pretreatment Perform a heat treatment at 150±1.8°C for 60±5 min. and then let sit for 24±2 hrs. at *room condition.						
9	Discharge Test (Application: Nominal Capacitance C<10,000pF)	Appearance No defects or abnormalities	As in Fig., discharge is made 50 times at 5 sec. intervals from the capacitor (Cd) charged at DC voltage of specified.  Ct : Capacitor under test Cd : 0.001μF R1 : 1,000Ω R2 : 100MΩ R3 : Surge resistance						
10	Adhesive Strength of Termination	No removal of the terminations or other defects should occur.	Solder the capacitor to the testing jig (glass epoxy board) shown in Fig. 1 using a eutectic solder. Then apply 10N force in the direction of the arrow. The soldering should be done either with an iron or using the reflow method and should be conducted with care so that the soldering is uniform and free of defects such as heat shock.  Fig. 1						
11	Vibration Resistance	Appearance	No defects or abnormalities						
		Capacitance	Within the specified tolerance						
		D.F.	0.025 max.						
			Solder the capacitor to the test jig (glass epoxy board). The capacitor should be subjected to a simple harmonic motion having a total amplitude of 1.5mm, the frequency being varied uniformly between the approximate limits of 10 and 55Hz. The frequency range, from 10 to 55Hz and return to 10Hz, should be traversed in approximately 1 min. This motion should be applied for a period of 2 hrs. in each 3 mutually perpendicular directions (total of 6 hrs.). 						

\* "Room condition" Temperature : 15 to 35°C, Relative humidity : 45 to 75%, Atmospheric pressure : 86 to 106kPa

Continued on the following page. 

## Specifications and Test Methods

Continued from the preceding page.

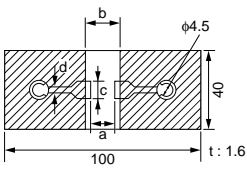
No.	Item	Specifications	Test Method																			
12	Deflection	No cracking or marking defects should occur.	Solder the capacitor to the testing jig (glass epoxy board) shown in Fig. 2 using a eutectic solder. Then apply a force in the direction shown in Fig. 3. The soldering should be done either with an iron or using the reflow method and should be conducted with care so that the soldering is uniform and free of defects such as heat shock.																			
		 <table border="1" style="margin: 10px auto; border-collapse: collapse;"> <thead> <tr> <th rowspan="2">L×W (mm)</th> <th colspan="4">Dimension (mm)</th> </tr> <tr> <th>a</th> <th>b</th> <th>c</th> <th>d</th> </tr> </thead> <tbody> <tr> <td>4.5×2.0</td> <td>3.5</td> <td>7.0</td> <td>2.4</td> <td rowspan="3" style="text-align: center; vertical-align: middle;">1.0</td> </tr> <tr> <td>4.5×3.2</td> <td>3.5</td> <td>7.0</td> <td>3.7</td> </tr> <tr> <td>5.7×5.0</td> <td>4.5</td> <td>8.0</td> <td>5.6</td> </tr> </tbody> </table> <p style="text-align: center;">Fig. 2</p>		L×W (mm)	Dimension (mm)				a	b	c	d	4.5×2.0	3.5	7.0	2.4	1.0	4.5×3.2	3.5	7.0	3.7	5.7×5.0
L×W (mm)	Dimension (mm)																					
	a	b	c	d																		
4.5×2.0	3.5	7.0	2.4	1.0																		
4.5×3.2	3.5	7.0	3.7																			
5.7×5.0	4.5	8.0	5.6																			
13	Solderability of Termination	75% of the terminations are to be soldered evenly and continuously.	Immerse the capacitor in a solution of ethanol (JIS-K-8101) and rosin (JIS-K-5902) (25% rosin in weight proportion). Immerse in solder solution for 2±0.5 sec. Immersing speed : 25±2.5mm/s Temp. of solder : 245±5°C Lead Free Solder (Sn-3.0Ag-0.5Cu) 235±5°C H60A or H63A Eutectic Solder																			
14	Humidity Insulation	Appearance	No marking defects																			
		Capacitance Change	Within ±15%																			
		D.F.	0.05 max.																			
		I.R.	More than 1,000MΩ																			
15	Resistance to Soldering Heat	Appearance	No marking defects																			
		Capacitance Change	Within ±10%																			
		D.F.	0.025 max.																			
		I.R.	More than 2,000MΩ																			
16	Temperature Cycle	Appearance	No marking defects																			
		Capacitance Change	Within ±15%																			
		D.F.	0.05 max.																			
		I.R.	More than 2,000MΩ																			
16	Dielectric Strength	In accordance with item No.4	Preheat the capacitor as table. Immerse the capacitor in solder solution at 260±5°C for 10±1 sec. Let sit at *room condition for 24±2 hrs., then measure. •Immersing speed : 25±2.5mm/s •Pretreatment Perform a heat treatment at 150±18°C for 60±5 min. and then let sit for 24±2 hrs. at *room condition. *Preheating																			
		In accordance with item No.4	Fix the capacitor to the supporting jig (glass epoxy board) shown in Fig. 4 using a eutectic solder. Perform the 5 cycles according to the 4 heat treatments listed in the following table. Let sit for 24±2 hrs. at *room condition, then measure.																			

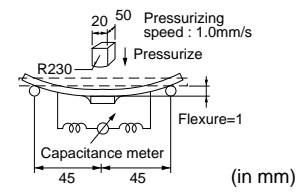

Fig. 3

Step	Temperature	Time
1	100 to 120°C	1 min.
2	170 to 200°C	1 min.

Step	Temperature (°C)	Time (min.)
1	Min. Operating Temp.±3	30±3
2	Room Temp.	2 to 3
3	Max. Operating Temp.±2	30±3
4	Room Temp.	2 to 3

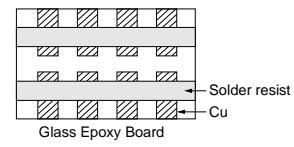

Fig. 4

\* "Room condition" Temperature : 15 to 35°C, Relative humidity : 45 to 75%, Atmospheric pressure : 86 to 106kPa

Continued on the following page.

## Specifications and Test Methods

Continued from the preceding page.

No.	Item	Specifications	Test Method									
17	Humidity (Steady State)	Appearance	No marking defects									
		Capacitance Change	Within $\pm 15\%$									
		D.F.	0.05 max.									
		I.R.	More than 1,000M $\Omega$									
		Dielectric Strength	In accordance with item No.4									
			Let the capacitor sit at $40\pm 2^{\circ}\text{C}$ and relative humidity of 90 to 95% for $500^{\pm 2}_{\pm 4}$ hrs. Remove and let sit for $24\pm 2$ hrs. at *room condition, then measure. •Pretreatment Perform a heat treatment at $150^{\pm 1}_{\pm 8}$ $^{\circ}\text{C}$ for $60\pm 5$ min. and then let sit for $24\pm 2$ hrs. at *room condition.									
18	Life	Appearance	No marking defects									
		Capacitance Change	Within $\pm 20\%$									
		D.F.	0.05 max.									
		I.R.	More than 1,000M $\Omega$									
		Dielectric Strength	In accordance with item No.4									
			Apply voltage and time as Table at $85\pm 2^{\circ}\text{C}$ . Remove and let sit for $24 \pm 2$ hrs. at *room condition, then measure. The charge / discharge current is less than 50mA. <table border="1" style="margin-left: auto; margin-right: auto;"> <thead> <tr> <th>Nominal Capacitance</th> <th>Test Time</th> <th>Test voltage</th> </tr> </thead> <tbody> <tr> <td><math>C \geq 10,000\text{pF}</math></td> <td><math>1,000^{\pm 4}_{\pm 8}</math> hrs.</td> <td>AC300V(r.m.s.)</td> </tr> <tr> <td><math>C &lt; 10,000\text{pF}</math></td> <td><math>1,500^{\pm 4}_{\pm 8}</math> hrs.</td> <td>AC500V(r.m.s.) *</td> </tr> </tbody> </table> * Except that once each hour the voltage is increased to AC1,000V (r.m.s.) for 0.1 sec. •Pretreatment Apply test voltage for $60\pm 5$ min. at test temperature. Remove and let sit for $24\pm 2$ hrs. at *room condition.	Nominal Capacitance	Test Time	Test voltage	$C \geq 10,000\text{pF}$	$1,000^{\pm 4}_{\pm 8}$ hrs.	AC300V(r.m.s.)	$C < 10,000\text{pF}$	$1,500^{\pm 4}_{\pm 8}$ hrs.	AC500V(r.m.s.) *
Nominal Capacitance	Test Time	Test voltage										
$C \geq 10,000\text{pF}$	$1,000^{\pm 4}_{\pm 8}$ hrs.	AC300V(r.m.s.)										
$C < 10,000\text{pF}$	$1,500^{\pm 4}_{\pm 8}$ hrs.	AC500V(r.m.s.) *										
19	Humidity Loading	Appearance	No marking defects									
		Capacitance Change	Within $\pm 15\%$									
		D.F.	0.05 max.									
		I.R.	More than 1,000M $\Omega$									
		Dielectric Strength	In accordance with item No.4									
			Apply the rated voltage at $40\pm 2^{\circ}\text{C}$ and relative humidity of 90 to 95% for $500^{\pm 2}_{\pm 4}$ hrs. Remove and let sit for $24\pm 2$ hrs. at *room condition, then measure. •Pretreatment Apply test voltage for $60\pm 5$ min. at test temperature. Remove and let sit for $24\pm 2$ hrs. at *room condition.									

\* "Room condition" Temperature : 15 to 35 $^{\circ}\text{C}$ , Relative humidity : 45 to 75%, Atmospheric pressure : 86 to 106kPa

# Chip Monolithic Ceramic Capacitors



## Safety Standard Recognized Type GC (UL, IEC60384-14 Class X1/Y2)

### ■ Features

1. Chip monolithic ceramic capacitor (certified as conforming to safety standards) for AC lines.
2. A new monolithic structure for small, high capacitance capable of operating at high voltage levels.
3. Compared to lead type capacitors, this new capacitor is greatly downsized and low-profiled to 1/10 or less in volume, and 1/4 or less in height.
4. The type GC can be used as an X1-class and Y2-class capacitor, line-by-pass capacitor of UL1414.
5. +125 degree C guaranteed
6. Only for reflow soldering

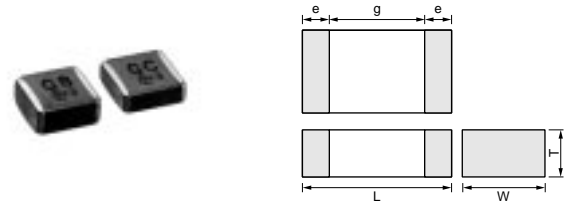

Part Number	Dimensions (mm)				
	L	W	T	e min.	g min.
<b>GA355D</b>	5.7 ±0.4	5.0 ±0.4	2.0 ±0.3	0.3	4.0

### ■ Applications

1. Ideal for use as Y capacitor or X capacitor for various switching power supplies
2. Ideal for modem applications

### ■ Standard Recognition

	Standard No.	Status of Recognition		Rated Voltage
		Type GB	Type GC	
UL	UL1414	—	◎*	AC250V (r.m.s.)
BSI	EN132400	—	◎	
VDE		◎	◎	
SEV		◎	◎	
SEMKO		◎	◎	
EN132400 Class		X2	X1, Y2	

\*: Line-By-Pass only

Part Number	Rated Voltage (V)	TC Code (Standard)	Capacitance (pF)	Length L (mm)	Width W (mm)	Thickness T (mm)	Electrode g min. (mm)	Electrode e (mm)
<b>GA355DR7GC101KY02L</b>	AC250 (r.m.s.)	X7R (EIA)	100 ±10%	5.7	5.0	2.0	4.0	0.3 min.
<b>GA355DR7GC151KY02L</b>	AC250 (r.m.s.)	X7R (EIA)	150 ±10%	5.7	5.0	2.0	4.0	0.3 min.
<b>GA355DR7GC221KY02L</b>	AC250 (r.m.s.)	X7R (EIA)	220 ±10%	5.7	5.0	2.0	4.0	0.3 min.
<b>GA355DR7GC331KY02L</b>	AC250 (r.m.s.)	X7R (EIA)	330 ±10%	5.7	5.0	2.0	4.0	0.3 min.

# Chip Monolithic Ceramic Capacitors



## Safety Standard Recognized Type GD (IEC60384-14 Class Y3)

### ■ Features

1. A new monolithic structure for small, high capacitance capable of operating at high voltage levels.
2. The type GD can be used as a Y3-class capacitor.
3. Available for equipment based on IEC/EN60950 and UL1950.
4. +125 degree C guaranteed
5. Only for reflow soldering
6. The low-profile type (thickness: 1.5mm max.) is available. Fit for use on thinner type equipment.

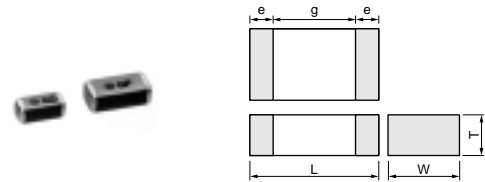

Part Number	Dimensions (mm)				
	L	W	T	e min.	g min.
<b>GA342D</b>	4.5 ±0.3	2.0 ±0.2	2.0 ±0.2*	0.3	2.5
<b>GA342Q</b>			1.5 +0, -0.3		
<b>GA343D</b>	4.5 ±0.4	3.2 ±0.3	2.0 +0, -0.3		
<b>GA343Q</b>			1.5 +0, -0.3		

\* GA342D1X : 2.0±0.3

### ■ Applications

1. Ideal for use on line filters and couplings for DAA modems without transformers
2. Ideal for use on line filters for information equipment

### ■ Standard Recognition

	Standard No.	Class	Status of Recognition	Rated Voltage
			Type GD	
SEMKO	EN132400	Y3	⊙	AC250V(r.m.s.)

#### Applications

Size	Switching power supplies	Communication network devices such as a modem
4.5×3.2mm and under	—	⊙

Part Number	Rated Voltage (V)	TC Code (Standard)	Capacitance (pF)	Length L (mm)	Width W (mm)	Thickness T (mm)	Electrode g min. (mm)	Electrode e (mm)
<b>GA342D1XGD100JY02L</b>	AC250 (r.m.s.)	SL (JIS)	10 ±5%	4.5	2.0	2.0	2.5	0.3 min.
<b>GA342D1XGD120JY02L</b>	AC250 (r.m.s.)	SL (JIS)	12 ±5%	4.5	2.0	2.0	2.5	0.3 min.
<b>GA342D1XGD150JY02L</b>	AC250 (r.m.s.)	SL (JIS)	15 ±5%	4.5	2.0	2.0	2.5	0.3 min.
<b>GA342D1XGD180JY02L</b>	AC250 (r.m.s.)	SL (JIS)	18 ±5%	4.5	2.0	2.0	2.5	0.3 min.
<b>GA342D1XGD220JY02L</b>	AC250 (r.m.s.)	SL (JIS)	22 ±5%	4.5	2.0	2.0	2.5	0.3 min.
<b>GA342D1XGD270JY02L</b>	AC250 (r.m.s.)	SL (JIS)	27 ±5%	4.5	2.0	2.0	2.5	0.3 min.
<b>GA342D1XGD330JY02L</b>	AC250 (r.m.s.)	SL (JIS)	33 ±5%	4.5	2.0	2.0	2.5	0.3 min.
<b>GA342D1XGD390JY02L</b>	AC250 (r.m.s.)	SL (JIS)	39 ±5%	4.5	2.0	2.0	2.5	0.3 min.
<b>GA342D1XGD470JY02L</b>	AC250 (r.m.s.)	SL (JIS)	47 ±5%	4.5	2.0	2.0	2.5	0.3 min.
<b>GA342D1XGD560JY02L</b>	AC250 (r.m.s.)	SL (JIS)	56 ±5%	4.5	2.0	2.0	2.5	0.3 min.
<b>GA342D1XGD680JY02L</b>	AC250 (r.m.s.)	SL (JIS)	68 ±5%	4.5	2.0	2.0	2.5	0.3 min.
<b>GA342D1XGD820JY02L</b>	AC250 (r.m.s.)	SL (JIS)	82 ±5%	4.5	2.0	2.0	2.5	0.3 min.
<b>GA342QR7GD101KW01L</b>	AC250 (r.m.s.)	X7R (EIA)	100 ±10%	4.5	2.0	1.5	2.5	0.3 min.
<b>GA342QR7GD151KW01L</b>	AC250 (r.m.s.)	X7R (EIA)	150 ±10%	4.5	2.0	1.5	2.5	0.3 min.
<b>GA342QR7GD221KW01L</b>	AC250 (r.m.s.)	X7R (EIA)	220 ±10%	4.5	2.0	1.5	2.5	0.3 min.
<b>GA342QR7GD331KW01L</b>	AC250 (r.m.s.)	X7R (EIA)	330 ±10%	4.5	2.0	1.5	2.5	0.3 min.
<b>GA342QR7GD471KW01L</b>	AC250 (r.m.s.)	X7R (EIA)	470 ±10%	4.5	2.0	1.5	2.5	0.3 min.
<b>GA342QR7GD681KW01L</b>	AC250 (r.m.s.)	X7R (EIA)	680 ±10%	4.5	2.0	1.5	2.5	0.3 min.
<b>GA342QR7GD102KW01L</b>	AC250 (r.m.s.)	X7R (EIA)	1000 ±10%	4.5	2.0	1.5	2.5	0.3 min.
<b>GA342QR7GD152KW01L</b>	AC250 (r.m.s.)	X7R (EIA)	1500 ±10%	4.5	2.0	1.5	2.5	0.3 min.
<b>GA343QR7GD182KW01L</b>	AC250 (r.m.s.)	X7R (EIA)	1800 ±10%	4.5	3.2	1.5	2.5	0.3 min.
<b>GA343QR7GD222KW01L</b>	AC250 (r.m.s.)	X7R (EIA)	2200 ±10%	4.5	3.2	1.5	2.5	0.3 min.
<b>GA343DR7GD472KW01L</b>	AC250 (r.m.s.)	X7R (EIA)	4700 ±10%	4.5	3.2	2.0	2.5	0.3 min.



# Chip Monolithic Ceramic Capacitors



## Safety Standard Recognized Type GF (IEC60384-14 Class Y2, X1/Y2)

### ■ Features

1. A new monolithic structure for small, high capacitance capable of operating at high voltage levels.
2. The type GF can be used as a Y2-class capacitor.
3. Available for equipment based on IEC/EN60950 and UL1950. Besides, the GA352/355 types are available for equipment based on IEC/EN60065, UL1492, and UL6500.
4. +125 degree C guaranteed
5. Only for reflow soldering
6. The low-profile type (thickness: 1.5mm max.) is available. Fit for use on thinner type equipment.

### ■ Applications

1. Ideal for use on line filters and couplings for DAA modems without transformers
2. Ideal for use on line filters for information equipment
3. Ideal for use as Y capacitor or X capacitor for various switching power supplies (GA352/355 types only)

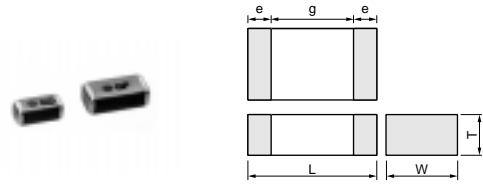

Part Number	Dimensions (mm)				
	L	W	T	e min.	g min.
GA342D	4.5 ±0.3	2.0 ±0.2	2.0 ±0.2*	0.3	2.5
GA342Q			1.5 +0, -0.3		
GA352Q	2.8 ±0.3	1.5 +0, -0.3			
GA355D	5.7 ±0.4	5.0 ±0.4	2.0 +0, -0.3		4.0
GA355Q			1.5 +0, -0.3		

\* GA342D1X : 2.0±0.3

### ■ Standard Recognition

	Standard No.	Class	Status of Recognition		Rated Voltage
			Type GF		
			Size : 4.5x2.0mm	Size : 5.7x2.8mm and over	
UL	UL1414	X1, Y2	—	⊙	AC250V (r.m.s.)
SEMKO	EN132400	Y2	⊙	⊙	

#### Applications

Size	Switching power supplies	Communication network devices such as a modem
4.5x2.0mm	—	⊙
5.7x2.8mm and over	⊙	⊙

Part Number	Rated Voltage (V)	TC Code (Standard)	Capacitance (pF)	Length L (mm)	Width W (mm)	Thickness T (mm)	Electrode g min. (mm)	Electrode e (mm)
GA342D1XGF100JY02L	AC250 (r.m.s.)	SL (JIS)	10 ±5%	4.5	2.0	2.0	2.5	0.3 min.
GA342D1XGF120JY02L	AC250 (r.m.s.)	SL (JIS)	12 ±5%	4.5	2.0	2.0	2.5	0.3 min.
GA342D1XGF150JY02L	AC250 (r.m.s.)	SL (JIS)	15 ±5%	4.5	2.0	2.0	2.5	0.3 min.
GA342D1XGF180JY02L	AC250 (r.m.s.)	SL (JIS)	18 ±5%	4.5	2.0	2.0	2.5	0.3 min.
GA342D1XGF220JY02L	AC250 (r.m.s.)	SL (JIS)	22 ±5%	4.5	2.0	2.0	2.5	0.3 min.
GA342D1XGF270JY02L	AC250 (r.m.s.)	SL (JIS)	27 ±5%	4.5	2.0	2.0	2.5	0.3 min.
GA342D1XGF330JY02L	AC250 (r.m.s.)	SL (JIS)	33 ±5%	4.5	2.0	2.0	2.5	0.3 min.
GA342D1XGF390JY02L	AC250 (r.m.s.)	SL (JIS)	39 ±5%	4.5	2.0	2.0	2.5	0.3 min.
GA342D1XGF470JY02L	AC250 (r.m.s.)	SL (JIS)	47 ±5%	4.5	2.0	2.0	2.5	0.3 min.
GA342D1XGF560JY02L	AC250 (r.m.s.)	SL (JIS)	56 ±5%	4.5	2.0	2.0	2.5	0.3 min.
GA342D1XGF680JY02L	AC250 (r.m.s.)	SL (JIS)	68 ±5%	4.5	2.0	2.0	2.5	0.3 min.
GA342D1XGF820JY02L	AC250 (r.m.s.)	SL (JIS)	82 ±5%	4.5	2.0	2.0	2.5	0.3 min.
GA342QR7GF101KW01L	AC250 (r.m.s.)	X7R (EIA)	100 ±10%	4.5	2.0	1.5	2.5	0.3 min.
GA342QR7GF151KW01L	AC250 (r.m.s.)	X7R (EIA)	150 ±10%	4.5	2.0	1.5	2.5	0.3 min.
GA342DR7GF221KW02L	AC250 (r.m.s.)	X7R (EIA)	220 ±10%	4.5	2.0	2.0	2.5	0.3 min.
GA342DR7GF331KW02L	AC250 (r.m.s.)	X7R (EIA)	330 ±10%	4.5	2.0	2.0	2.5	0.3 min.
GA352QR7GF471KW01L	AC250 (r.m.s.)	X7R (EIA)	470 ±10%	5.7	2.8	1.5	4.0	0.3 min.
GA352QR7GF681KW01L	AC250 (r.m.s.)	X7R (EIA)	680 ±10%	5.7	2.8	1.5	4.0	0.3 min.
GA352QR7GF102KW01L	AC250 (r.m.s.)	X7R (EIA)	1000 ±10%	5.7	2.8	1.5	4.0	0.3 min.
GA352QR7GF152KW01L	AC250 (r.m.s.)	X7R (EIA)	1500 ±10%	5.7	2.8	1.5	4.0	0.3 min.
GA355QR7GF182KW01L	AC250 (r.m.s.)	X7R (EIA)	1800 ±10%	5.7	5.0	1.5	4.0	0.3 min.
GA355QR7GF222KW01L	AC250 (r.m.s.)	X7R (EIA)	2200 ±10%	5.7	5.0	1.5	4.0	0.3 min.
GA355QR7GF332KW01L	AC250 (r.m.s.)	X7R (EIA)	3300 ±10%	5.7	5.0	1.5	4.0	0.3 min.
GA355DR7GF472KW01L	AC250 (r.m.s.)	X7R (EIA)	4700 ±10%	5.7	5.0	2.0	4.0	0.3 min.

# Chip Monolithic Ceramic Capacitors



## Safety Standard Recognized Type GB (IEC60384-14 Class X2)

### ■ Features

1. Chip monolithic ceramic capacitor (certified as conforming to safety standards) for AC lines.
2. A new monolithic structure for small, high capacitance capable of operating at high voltage levels.
3. Compared to lead type capacitors, this new capacitor is greatly downsized and low-profiled to 1/10 or less in volume, and 1/4 or less in height.
4. The type GB can be used as an X2-class capacitor.
5. +125 degree C guaranteed
6. Only for reflow soldering

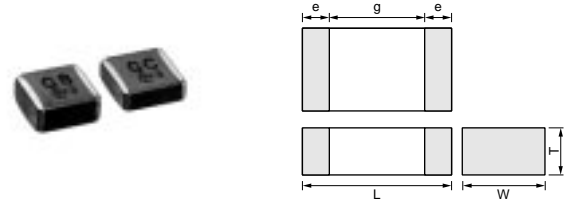

Part Number	Dimensions (mm)				
	L	W	T	e min.	g min.
<b>GA355D</b>	5.7 ±0.4	5.0 ±0.4	2.0 ±0.3	0.3	4.0
<b>GA355X</b>			2.7 ±0.3		

### ■ Applications

Ideal for use as X capacitor for various switching power supplies

### ■ Standard Recognition

	Standard No.	Status of Recognition		Rated Voltage
		Type GB	Type GC	
UL	UL1414	—	◎*	AC250V (r.m.s.)
BSI	EN132400	—	◎	
VDE		◎	◎	
SEV		◎	◎	
SEMKO		◎	◎	
EN132400 Class		X2	X1, Y2	

\*: Line-By-Pass only

Part Number	Rated Voltage (V)	TC Code (Standard)	Capacitance (pF)	Length L (mm)	Width W (mm)	Thickness T (mm)	Electrode g min. (mm)	Electrode e (mm)
<b>GA355DR7GB103KY02L</b>	AC250 (r.m.s.)	X7R (EIA)	10000 ±10%	5.7	5.0	2.0	4.0	0.3 min.
<b>GA355DR7GB153KY02L</b>	AC250 (r.m.s.)	X7R (EIA)	15000 ±10%	5.7	5.0	2.0	4.0	0.3 min.
<b>GA355DR7GB223KY02L</b>	AC250 (r.m.s.)	X7R (EIA)	22000 ±10%	5.7	5.0	2.0	4.0	0.3 min.
<b>GA355XR7GB333KY06L</b>	AC250 (r.m.s.)	X7R (EIA)	33000 ±10%	5.7	5.0	2.7	4.0	0.3 min.

## GA3 Series Specifications and Test Methods

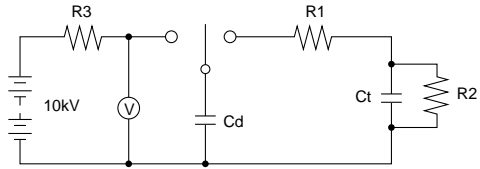
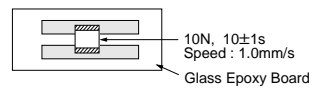
No.	Item	Specifications	Test Method								
1	Operating Temperature Range	-55 to +125°C	-								
2	Appearance	No defects or abnormalities	Visual inspection								
3	Dimensions	Within the specified dimensions	Using calipers								
4	Dielectric Strength	No defects or abnormalities	No failure should be observed when voltage in table is applied between the terminations for 60±1 sec., provided the charge/discharge current is less than 50mA. <table border="1" style="margin-left: auto; margin-right: auto; border-collapse: collapse;"> <thead> <tr style="background-color: #e0e0e0;"> <th colspan="2">Test Voltage</th> </tr> </thead> <tbody> <tr> <td>Type GB</td> <td>DC1075V</td> </tr> <tr> <td>Type GC/GD/GF</td> <td>AC1500V(r.m.s.)</td> </tr> </tbody> </table>	Test Voltage		Type GB	DC1075V	Type GC/GD/GF	AC1500V(r.m.s.)		
Test Voltage											
Type GB	DC1075V										
Type GC/GD/GF	AC1500V(r.m.s.)										
5	Pulse Voltage (Application: Type GD/GF)	No self healing break downs or flash-overs have taken place in the capacitor.	10 impulse of alternating polarity is subjected. (5 impulse for each polarity) The interval between impulse is 60 sec. Applied Voltage : 2.5kV zero to peak								
6	Insulation Resistance (I.R.)	More than 6,000MΩ	The insulation resistance should be measured with DC500±50V and within 60±5 sec. of charging.								
7	Capacitance	Within the specified tolerance	The capacitance/Q/D.F. should be measured at 20°C at a frequency of 1±0.2kHz (SL char. : 1±0.2MHz) and a voltage of AC1±0.2V(r.m.s.).								
8	Dissipation Factor (D.F.) Q	<table border="1" style="margin-left: auto; margin-right: auto; border-collapse: collapse;"> <thead> <tr style="background-color: #e0e0e0;"> <th>Char.</th> <th>Specification</th> </tr> </thead> <tbody> <tr> <td>X7R</td> <td>D.F. ≤ 0.025</td> </tr> <tr> <td rowspan="2">SL</td> <td>Q ≥ 400 + 20C*<sup>2</sup> (C &lt; 30pF)</td> </tr> <tr> <td>Q ≥ 1000 (C ≥ 30pF)</td> </tr> </tbody> </table>	Char.	Specification	X7R	D.F. ≤ 0.025	SL	Q ≥ 400 + 20C* <sup>2</sup> (C < 30pF)	Q ≥ 1000 (C ≥ 30pF)	•Pretreatment for X7R char. Perform a heat treatment at 150 ± 10°C for 60±5 min. and then let sit for 24±2 hrs. at *room condition.	
Char.	Specification										
X7R	D.F. ≤ 0.025										
SL	Q ≥ 400 + 20C* <sup>2</sup> (C < 30pF)										
	Q ≥ 1000 (C ≥ 30pF)										
9	Capacitance Temperature Characteristics	<table border="1" style="margin-left: auto; margin-right: auto; border-collapse: collapse;"> <thead> <tr style="background-color: #e0e0e0;"> <th>Char.</th> <th>Capacitance Change</th> </tr> </thead> <tbody> <tr> <td>X7R</td> <td>Within ±15%</td> </tr> </tbody> </table> Temperature characteristic guarantee is -55 to +125°C  <table border="1" style="margin-left: auto; margin-right: auto; border-collapse: collapse;"> <thead> <tr style="background-color: #e0e0e0;"> <th>Char.</th> <th>Temperature Coefficient</th> </tr> </thead> <tbody> <tr> <td>SL</td> <td>+350 to -1000ppm/°C</td> </tr> </tbody> </table> Temperature characteristic guarantee is +20 to +85°C	Char.	Capacitance Change	X7R	Within ±15%	Char.	Temperature Coefficient	SL	+350 to -1000ppm/°C	The range of capacitance change compared with the 25°C (SL char. : 20°C) value within -55 to +125°C should be within the specified range. •Pretreatment for X7R char. Perform a heat treatment at 150 ± 10°C for 60±5 min. and then let sit for 24±2 hrs. at *room condition.
Char.	Capacitance Change										
X7R	Within ±15%										
Char.	Temperature Coefficient										
SL	+350 to -1000ppm/°C										
10	Appearance	No defects or abnormalities	As in Fig., discharge is made 50 times at 5 sec. intervals from the capacitor (Cd) charged at DC voltage of specified. <div style="text-align: center;">  <p style="margin: 0;">Ct : Capacitor under test   Cd : 0.001μF R1 : 1,000Ω   R2 : 100MΩ   R3 : Surge resistance</p> </div>								
	I.R.	More than 1,000MΩ									
	Dielectric Strength	In accordance with item No.4									
11	Adhesive Strength of Termination	No removal of the terminations or other defect should occur.	Solder the capacitor to the testing jig (glass epoxy board) shown in Fig. 1 using a eutectic solder. Then apply 10N force in the direction of the arrow. The soldering should be done either with an iron or using the reflow method and should be conducted with care so that the soldering is uniform and free of defects such as heat shock. <div style="text-align: center;">  <p style="margin: 0;">10N, 10±1s Speed : 1.0mm/s Glass Epoxy Board</p> </div> <p style="text-align: center;">Fig. 1</p>								

\*1 "Room condition" Temperature : 15 to 35°C, Relative humidity : 45 to 75%, Atmospheric pressure : 86 to 106kPa

\*2 "C" expresses nominal capacitance value (pF).

Continued on the following page.

## GA3 Series Specifications and Test Methods

Continued from the preceding page.

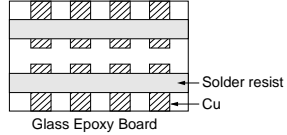
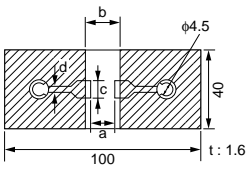
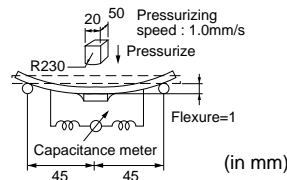
No.	Item	Specifications	Test Method																									
12	Appearance	No defects or abnormalities	Solder the capacitor to the test jig (glass epoxy board). The capacitor should be subjected to a simple harmonic motion having a total amplitude of 1.5mm, the frequency being varied uniformly between the approximate limits of 10 and 55Hz. The frequency range, from 10 to 55Hz and return to 10Hz, should be traversed in approximately 1 min. This motion should be applied for a period of 2 hrs. in each 3 mutually perpendicular directions (total of 6 hrs.).																									
	Capacitance	Within the specified tolerance																										
13	Vibration Resistance	<table border="1"> <thead> <tr> <th>Char.</th> <th>Specification</th> </tr> </thead> <tbody> <tr> <td>X7R</td> <td>D.F. ≤ 0.025</td> </tr> <tr> <td>SL</td> <td>Q ≥ 400 + 20C*2 (C &lt; 30pF) Q ≥ 1000 (C ≥ 30pF)</td> </tr> </tbody> </table>	Char.	Specification	X7R	D.F. ≤ 0.025	SL	Q ≥ 400 + 20C*2 (C < 30pF) Q ≥ 1000 (C ≥ 30pF)																				
			Char.	Specification																								
X7R	D.F. ≤ 0.025																											
SL	Q ≥ 400 + 20C*2 (C < 30pF) Q ≥ 1000 (C ≥ 30pF)																											
D.F. Q	 <table border="1"> <thead> <tr> <th>LxW (mm)</th> <th colspan="4">Dimension (mm)</th> </tr> <tr> <th></th> <th>a</th> <th>b</th> <th>c</th> <th>d</th> </tr> </thead> <tbody> <tr> <td>4.5x2.0</td> <td>3.5</td> <td>7.0</td> <td>2.4</td> <td rowspan="4">1.0</td> </tr> <tr> <td>4.5x3.2</td> <td>3.5</td> <td>7.0</td> <td>3.7</td> </tr> <tr> <td>5.7x2.8</td> <td>4.5</td> <td>8.0</td> <td>3.2</td> </tr> <tr> <td>5.7x5.0</td> <td>4.5</td> <td>8.0</td> <td>5.6</td> </tr> </tbody> </table> <p>Fig. 2</p>	LxW (mm)	Dimension (mm)					a	b	c	d	4.5x2.0	3.5	7.0	2.4	1.0	4.5x3.2	3.5	7.0	3.7	5.7x2.8	4.5	8.0	3.2	5.7x5.0	4.5	8.0	5.6
LxW (mm)	Dimension (mm)																											
	a	b	c	d																								
4.5x2.0	3.5	7.0	2.4	1.0																								
4.5x3.2	3.5	7.0	3.7																									
5.7x2.8	4.5	8.0	3.2																									
5.7x5.0	4.5	8.0	5.6																									
14	Deflection	No cracking or marking defects should occur.	Solder the capacitor to the testing jig (glass epoxy board) shown in Fig. 2 using a eutectic solder. Then apply a force in the direction shown in Fig. 3. The soldering should be done either with an iron or using the reflow method and should be conducted with care so that the soldering is uniform and free of defects such as heat shock.																									
				 <p>Fig. 3</p>																								
15	Solderability of Termination	75% of the terminations are to be soldered evenly and continuously.	Immerse the capacitor in a solution of ethanol (JIS-K-8101) and rosin (JIS-K-5902) (25% rosin in weight proportion). Immerse in solder solution for 2±0.5 sec. Immersing speed : 25±2.5mm/s Temp. of solder : 245±5°C Lead Free Solder (Sn-3.0Ag-0.5Cu) 235±5°C H60A or H63A Eutectic Solder																									
15	Resistance to Soldering Heat	Appearance	No marking defects																									
		Capacitance Change	<table border="1"> <thead> <tr> <th>Char.</th> <th>Capacitance Change</th> </tr> </thead> <tbody> <tr> <td>X7R</td> <td>Within ±10%</td> </tr> <tr> <td>SL</td> <td>Within ±2.5% or ±0.25pF (Whichever is larger)</td> </tr> </tbody> </table>	Char.	Capacitance Change	X7R	Within ±10%	SL	Within ±2.5% or ±0.25pF (Whichever is larger)																			
		Char.	Capacitance Change																									
		X7R	Within ±10%																									
SL	Within ±2.5% or ±0.25pF (Whichever is larger)																											
I.R.	More than 1,000MΩ																											
Dielectric Strength	In accordance with item No.4																											
			Preheat the capacitor as table. Immerse the capacitor in solder solution at 260±5°C for 10±1 sec. Let sit at *room condition for 24±2 hrs., then measure. •Immersing speed : 25±2.5mm/s •Pretreatment for X7R char. Perform a heat treatment at 150±10°C for 60±5 min. and then let sit for 24±2 hrs. at *room condition. *Preheating <table border="1"> <thead> <tr> <th>Step</th> <th>Temperature</th> <th>Time</th> </tr> </thead> <tbody> <tr> <td>1</td> <td>100 to 120°C</td> <td>1 min.</td> </tr> <tr> <td>2</td> <td>170 to 200°C</td> <td>1 min.</td> </tr> </tbody> </table>	Step	Temperature	Time	1	100 to 120°C	1 min.	2	170 to 200°C	1 min.																
Step	Temperature	Time																										
1	100 to 120°C	1 min.																										
2	170 to 200°C	1 min.																										

\*1 "Room condition" Temperature : 15 to 35°C, Relative humidity : 45 to 75%, Atmospheric pressure : 86 to 106kPa

\*2 "C" expresses nominal capacitance value (pF).

Continued on the following page. 

## GA3 Series Specifications and Test Methods

Continued from the preceding page.

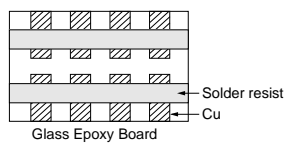
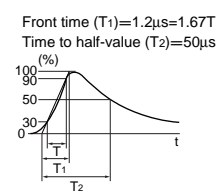
No.	Item	Specifications	Test Method															
16	Temperature Cycle	Appearance	No marking defects															
		Capacitance Change	<table border="1" style="width: 100%; border-collapse: collapse;"> <tr> <th style="width: 20%;">Char.</th> <th>Capacitance Change</th> </tr> <tr> <td>X7R</td> <td>Within ±15%</td> </tr> <tr> <td>SL</td> <td>Within ±2.5% or ±0.25pF (Whichever is larger)</td> </tr> </table>	Char.	Capacitance Change	X7R	Within ±15%	SL	Within ±2.5% or ±0.25pF (Whichever is larger)									
			Char.	Capacitance Change														
		X7R	Within ±15%															
		SL	Within ±2.5% or ±0.25pF (Whichever is larger)															
D.F. Q	<table border="1" style="width: 100%; border-collapse: collapse;"> <tr> <th style="width: 20%;">Char.</th> <th>Specification</th> </tr> <tr> <td>X7R</td> <td>D.F. ≤0.05</td> </tr> <tr> <td>SL</td> <td>Q ≥ 400 + 20C*2 (C &lt; 30pF) Q ≥ 1000 (C ≥ 30pF)</td> </tr> </table>	Char.	Specification	X7R	D.F. ≤0.05	SL	Q ≥ 400 + 20C*2 (C < 30pF) Q ≥ 1000 (C ≥ 30pF)											
	Char.	Specification																
X7R	D.F. ≤0.05																	
SL	Q ≥ 400 + 20C*2 (C < 30pF) Q ≥ 1000 (C ≥ 30pF)																	
I.R.	More than 3,000MΩ																	
Dielectric Strength	In accordance with item No.4																	
			<p>Fix the capacitor to the supporting jig (glass epoxy board) shown in Fig. 4 using a eutectic solder.</p> <p>Perform the 5 cycles according to the 4 heat treatments listed in the following table.</p> <p>Let sit for 24±2 hrs. at *room condition, then measure.</p> <table border="1" style="width: 100%; border-collapse: collapse;"> <thead> <tr> <th>Step</th> <th>Temperature (°C)</th> <th>Time (min.)</th> </tr> </thead> <tbody> <tr> <td>1</td> <td>Min. Operating Temp.±3</td> <td>30±3</td> </tr> <tr> <td>2</td> <td>Room Temp.</td> <td>2 to 3</td> </tr> <tr> <td>3</td> <td>Max. Operating Temp.±2</td> <td>30±3</td> </tr> <tr> <td>4</td> <td>Room Temp.</td> <td>2 to 3</td> </tr> </tbody> </table> <p>•Pretreatment for X7R char. Perform a heat treatment at 150 ± 1,8 °C for 60±5 min. and then let sit for 24±2 hrs. at *room condition.</p> <div style="text-align: center;">  <p>Fig. 4</p> </div>	Step	Temperature (°C)	Time (min.)	1	Min. Operating Temp.±3	30±3	2	Room Temp.	2 to 3	3	Max. Operating Temp.±2	30±3	4	Room Temp.	2 to 3
Step	Temperature (°C)	Time (min.)																
1	Min. Operating Temp.±3	30±3																
2	Room Temp.	2 to 3																
3	Max. Operating Temp.±2	30±3																
4	Room Temp.	2 to 3																
17	Humidity (Steady State)	Appearance	No marking defects															
		Capacitance Change	<table border="1" style="width: 100%; border-collapse: collapse;"> <tr> <th style="width: 20%;">Char.</th> <th>Capacitance Change</th> </tr> <tr> <td>X7R</td> <td>Within ±15%</td> </tr> <tr> <td>SL</td> <td>Within ±5.0% or ±0.5pF (Whichever is larger)</td> </tr> </table>	Char.	Capacitance Change	X7R	Within ±15%	SL	Within ±5.0% or ±0.5pF (Whichever is larger)									
			Char.	Capacitance Change														
		X7R	Within ±15%															
		SL	Within ±5.0% or ±0.5pF (Whichever is larger)															
D.F. Q	<table border="1" style="width: 100%; border-collapse: collapse;"> <tr> <th style="width: 20%;">Char.</th> <th>Specification</th> </tr> <tr> <td>X7R</td> <td>D.F. ≤0.05</td> </tr> <tr> <td>SL</td> <td>Q ≥ 275 + 5/2C*2 (C &lt; 30pF) Q ≥ 350 (C ≥ 30pF)</td> </tr> </table>	Char.	Specification	X7R	D.F. ≤0.05	SL	Q ≥ 275 + 5/2C*2 (C < 30pF) Q ≥ 350 (C ≥ 30pF)											
	Char.	Specification																
X7R	D.F. ≤0.05																	
SL	Q ≥ 275 + 5/2C*2 (C < 30pF) Q ≥ 350 (C ≥ 30pF)																	
I.R.	More than 3,000MΩ																	
Dielectric Strength	In accordance with item No.4																	
			<p>Before this test, the test shown in the following is performed.</p> <p>-Item 11 Adhesive Strength of Termination (apply force is 5N) -Item 13 Deflection</p> <p>Let the capacitor sit at 40±2°C and relative humidity of 90 to 95% for 500 ± 24 hrs.</p> <p>Remove and let sit for 24±2 hrs. at *room condition, then measure.</p> <p>•Pretreatment for X7R char. Perform a heat treatment at 150 ± 1,8 °C for 60±5 min. and then let sit for 24±2 hrs. at *room condition.</p>															
18	Life	Appearance	No marking defects															
		Capacitance Change	<table border="1" style="width: 100%; border-collapse: collapse;"> <tr> <th style="width: 20%;">Char.</th> <th>Capacitance Change</th> </tr> <tr> <td>X7R</td> <td>Within ±20%</td> </tr> <tr> <td>SL</td> <td>Within ±3.0% or ±0.3pF (Whichever is larger)</td> </tr> </table>	Char.	Capacitance Change	X7R	Within ±20%	SL	Within ±3.0% or ±0.3pF (Whichever is larger)									
			Char.	Capacitance Change														
		X7R	Within ±20%															
		SL	Within ±3.0% or ±0.3pF (Whichever is larger)															
D.F. Q	<table border="1" style="width: 100%; border-collapse: collapse;"> <tr> <th style="width: 20%;">Char.</th> <th>Specification</th> </tr> <tr> <td>X7R</td> <td>D.F. ≤0.05</td> </tr> <tr> <td>SL</td> <td>Q ≥ 275 + 5/2C*2 (C &lt; 30pF) Q ≥ 350 (C ≥ 30pF)</td> </tr> </table>	Char.	Specification	X7R	D.F. ≤0.05	SL	Q ≥ 275 + 5/2C*2 (C < 30pF) Q ≥ 350 (C ≥ 30pF)											
	Char.	Specification																
X7R	D.F. ≤0.05																	
SL	Q ≥ 275 + 5/2C*2 (C < 30pF) Q ≥ 350 (C ≥ 30pF)																	
I.R.	More than 3,000MΩ																	
Dielectric Strength	In accordance with item No.4																	
			<p>Before this test, the test shown in the following is performed.</p> <p>-Item 11 Adhesive Strength of Termination (apply force is 5N) -Item 13 Deflection</p> <p>Impulse Voltage Each individual capacitor should be subjected to a 2.5kV (Type GC/GF : 5kV) Impulses (the voltage value means zero to peak) for three times. Then the capacitors are applied to life test.</p> <div style="text-align: center;">  <p>Front time (T1)=1.2μs=1.67T Time to half-value (T2)=50μs</p> </div> <p>Apply voltage as Table for 1,000 hrs. at 125 ± 2 °C, relative humidity 50% max.</p> <table border="1" style="width: 100%; border-collapse: collapse;"> <thead> <tr> <th>Type</th> <th>Applied Voltage</th> </tr> </thead> <tbody> <tr> <td><b>GB</b></td> <td>AC312.5V(r.m.s.), except that once each hour the voltage is increased to AC1,000V(r.m.s.) for 0.1 sec.</td> </tr> <tr> <td><b>GC</b></td> <td rowspan="2">AC425V(r.m.s.), except that once each hour the voltage is increased to AC1,000V(r.m.s.) for 0.1 sec.</td> </tr> <tr> <td><b>GD</b></td> </tr> <tr> <td><b>GF</b></td> <td></td> </tr> </tbody> </table> <p>Let sit for 24±2 hrs. at *room condition, then measure.</p> <p>•Pretreatment for X7R char. Perform a heat treatment at 150 ± 1,8 °C for 60±5 min. and then let sit for 24±2 hrs. at *room condition.</p>	Type	Applied Voltage	<b>GB</b>	AC312.5V(r.m.s.), except that once each hour the voltage is increased to AC1,000V(r.m.s.) for 0.1 sec.	<b>GC</b>	AC425V(r.m.s.), except that once each hour the voltage is increased to AC1,000V(r.m.s.) for 0.1 sec.	<b>GD</b>	<b>GF</b>							
Type	Applied Voltage																	
<b>GB</b>	AC312.5V(r.m.s.), except that once each hour the voltage is increased to AC1,000V(r.m.s.) for 0.1 sec.																	
<b>GC</b>	AC425V(r.m.s.), except that once each hour the voltage is increased to AC1,000V(r.m.s.) for 0.1 sec.																	
<b>GD</b>																		
<b>GF</b>																		

\*1 "Room condition" Temperature : 15 to 35°C, Relative humidity : 45 to 75%, Atmospheric pressure : 86 to 106kPa

\*2 "C" expresses nominal capacitance value (pF).

Continued on the following page. ↗

## GA3 Series Specifications and Test Methods

Continued from the preceding page.

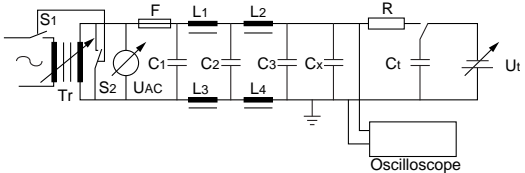
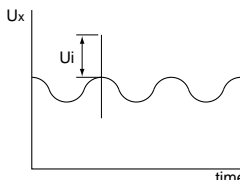
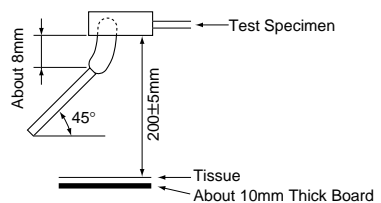
No.	Item	Specifications	Test Method																		
19	Appearance	No marking defects	Before this test, the test shown in the following is performed. -Item 11 Adhesive Strength of Termination (apply force is 5N) -Item 13 Deflection  Apply the rated voltage at $40\pm 2^{\circ}\text{C}$ and relative humidity of 90 to 95% for $500\pm 2^{\circ}\text{hrs}$ . Remove and let sit for $24\pm 2$ hrs. at *1room condition, then measure. •Pretreatment for X7R char. Perform a heat treatment at $150\pm 1^{\circ}\text{C}$ for $60\pm 5$ min. and then let sit for $24\pm 2$ hrs. at *1room condition.																		
	Capacitance Change	Char. X7R		Capacitance Change Within $\pm 15\%$																	
		SL		Within $\pm 5.0\%$ or $\pm 0.5\text{pF}$ (Whichever is larger)																	
	D.F. Q	Char. X7R		Specification D.F. $\leq 0.05$																	
		SL		$Q \geq 275 + 5/2C^{*2}$ (C < 30pF) $Q \geq 350$ (C $\geq 30\text{pF}$ )																	
I.R.	More than 3,000M $\Omega$																				
Dielectric Strength	In accordance with item No.4																				
20	Active Flammability	The cheese-cloth should not be on fire.	The capacitor should be individually wrapped in at least one but not more than two complete layers of cheese-cloth. The capacitor should be subjected to 20 discharges. The interval between successive discharges should be 5 sec. The UAC should be maintained for 2 min. after the last discharge.    <table border="0"> <tr> <td>C1,2 : <math>1\mu\text{F}\pm 10\%</math></td> <td>C3 : <math>0.033\mu\text{F}\pm 5\%</math> 10kV</td> </tr> <tr> <td>L1 to 4 : 1.5mH<math>\pm 20\%</math> 16A Rod core choke</td> <td></td> </tr> <tr> <td>Ct : <math>3\mu\text{F}\pm 5\%</math> 10kV</td> <td>R : <math>100\Omega\pm 2\%</math></td> </tr> <tr> <td>Cx : Capacitor under test</td> <td>UAC : <math>U_R\pm 5\%</math></td> </tr> <tr> <td>F : Fuse, Rated 16A</td> <td>UR : Rated Voltage</td> </tr> <tr> <td></td> <td>Ut : Voltage applied to Ct</td> </tr> </table>    <table border="1"> <thead> <tr> <th>Type</th> <th>Ui</th> </tr> </thead> <tbody> <tr> <td>GB, GD</td> <td>2.5kV</td> </tr> <tr> <td>GC, GF</td> <td>5kV</td> </tr> </tbody> </table>	C1,2 : $1\mu\text{F}\pm 10\%$	C3 : $0.033\mu\text{F}\pm 5\%$ 10kV	L1 to 4 : 1.5mH $\pm 20\%$ 16A Rod core choke		Ct : $3\mu\text{F}\pm 5\%$ 10kV	R : $100\Omega\pm 2\%$	Cx : Capacitor under test	UAC : $U_R\pm 5\%$	F : Fuse, Rated 16A	UR : Rated Voltage		Ut : Voltage applied to Ct	Type	Ui	GB, GD	2.5kV	GC, GF	5kV
				C1,2 : $1\mu\text{F}\pm 10\%$	C3 : $0.033\mu\text{F}\pm 5\%$ 10kV																
L1 to 4 : 1.5mH $\pm 20\%$ 16A Rod core choke																					
Ct : $3\mu\text{F}\pm 5\%$ 10kV	R : $100\Omega\pm 2\%$																				
Cx : Capacitor under test	UAC : $U_R\pm 5\%$																				
F : Fuse, Rated 16A	UR : Rated Voltage																				
	Ut : Voltage applied to Ct																				
Type	Ui																				
GB, GD	2.5kV																				
GC, GF	5kV																				
21	Passive Flammability	The burning time should not exceed 30 sec. The tissue paper should not ignite.	The capacitor under test should be held in the flame in the position which best promotes burning. Each specimen should only be exposed once to the flame. Time of exposure to flame: 30 sec.  Length of flame : $12\pm 1\text{mm}$ Gas burner : Length 35mm min. Inside Dia. $0.5\pm 0.1\text{mm}$ Outside Dia. 0.9mm max. Gas : Butane gas Purity 95% min.  																		

\*1 "Room condition" Temperature : 15 to 35°C, Relative humidity : 45 to 75%, Atmospheric pressure : 86 to 106kPa

\*2 "C" expresses nominal capacitance value (pF).

## GRM/GR4/GR7/GA2/GA3 Series Data (Typical Example)

### ■ Capacitance-Temperature Characteristics

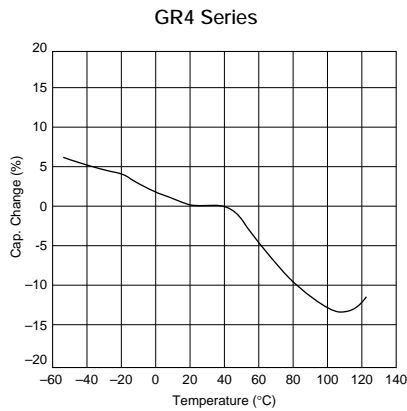
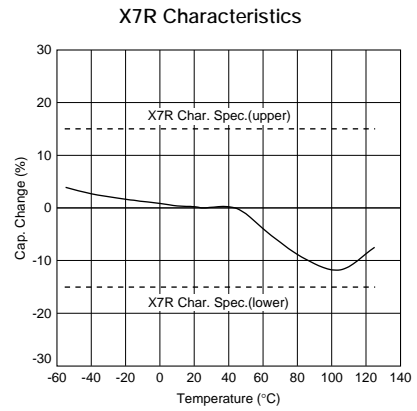
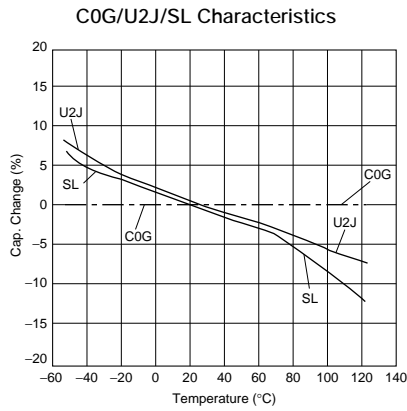

### ■ Impedance-Frequency Characteristics

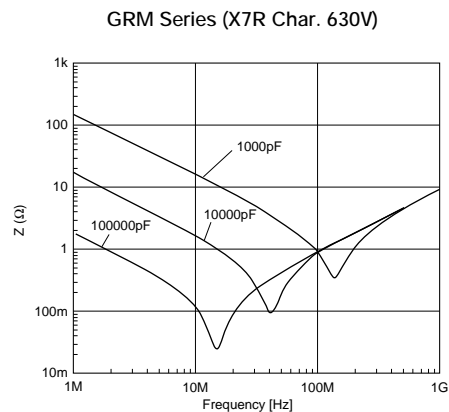
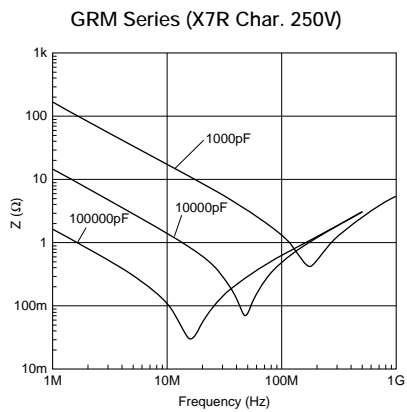

Continued on the following page.

## GRM/GR4/GR7/GA2/GA3 Series Data (Typical Example)

Continued from the preceding page.

### Impedance-Frequency Characteristics

GR4 Series

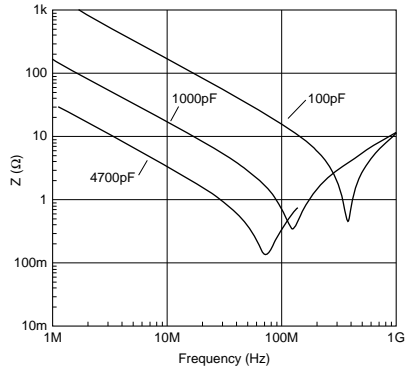

GR7 Series

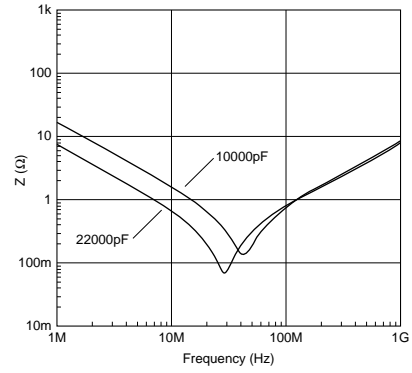

GA2 Series

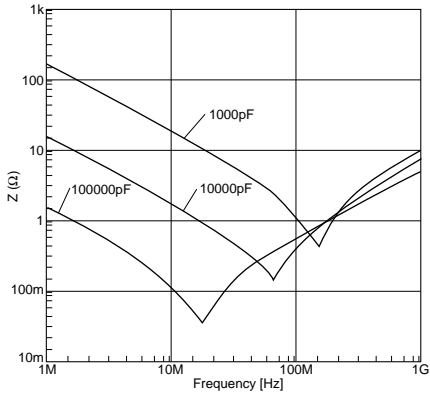

GA3 Series (Type GD)

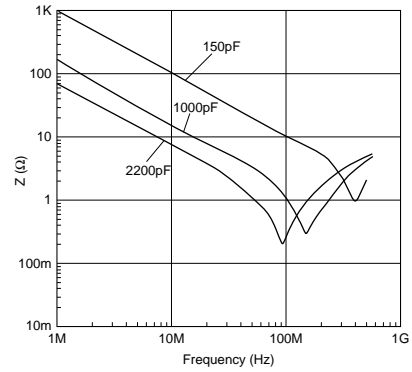

GA3 Series (Type GF)

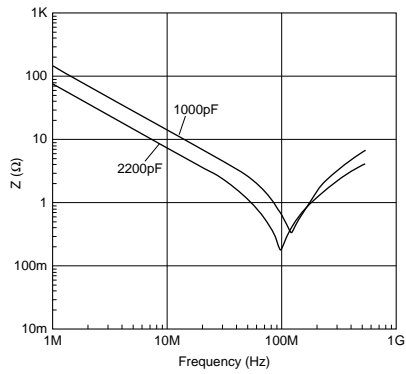

GA3 Series (Type GB)

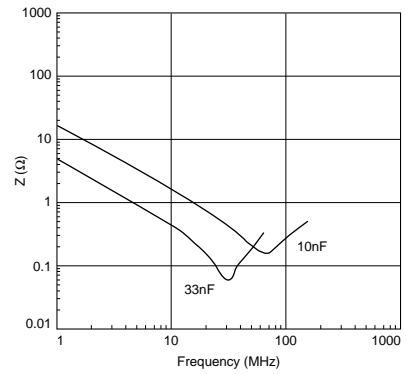



## GRM/GR4/GR7/GA2/GA3 Series Data (Typical Example)

### ■ Capacitance-AC Voltage Characteristics

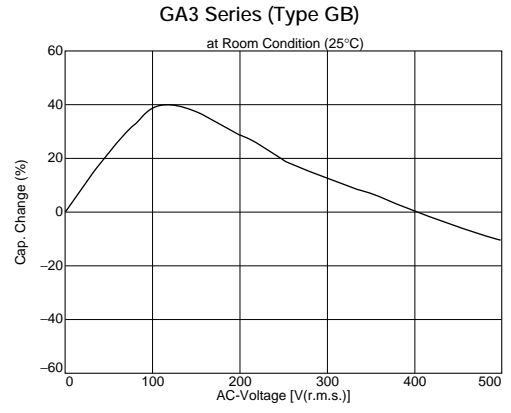
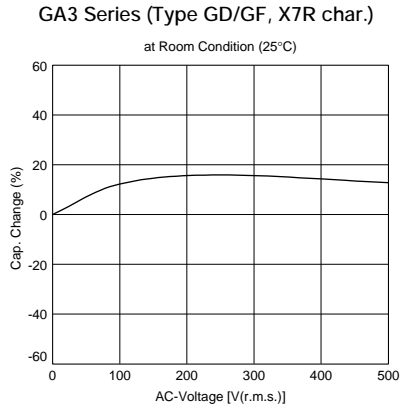

## Package

Taping is standard packaging method.

### ■ Minimum Quantity Guide

Part Number		Dimensions (mm)			Quantity (pcs.)	
					φ180mm reel	
		L	W	T	Paper Tape	Embossed Tape
Medium-voltage	GRM18	1.6	0.8	0.8	4,000	-
	GRM21	2.0	1.25	1.0	4,000	-
				1.25	-	3,000
	GRM31/GR731	3.2	1.6	1.0	4,000	-
				1.25	-	3,000
				1.6	-	2,000
	GRM32	3.2	2.5	1.0	4,000	-
				1.25	-	3,000
				1.5	-	2,000
				2.0	-	1,000
	GRM42/GR442	4.5	2.0	1.0	-	3,000
				1.5	-	2,000
2.0				-	2,000	
GRM43/GR443	4.5	3.2	1.5	-	1,000	
			2.0	-	1,000	
			2.5	-	500	
GRM55	5.7	5.0	2.0	-	1,000	
AC250V	GA242	4.5	2.0	1.5	-	2,000
	GA243	4.5	3.2	1.5	-	1,000
				2.0	-	1,000
GA255	5.7	5.0	2.0	-	1,000	
Safety Std. Recognition	GA342	4.5	2.0	1.5	-	2,000
				2.0	-	2,000
	GA343	4.5	3.2	1.5	-	1,000
				2.0	-	1,000
	GA352	5.7	2.8	1.5	-	1,000
	GA355	5.7	5.0	1.5	-	1,000
				2.0	-	1,000
			2.7	-	500	

### ■ Tape Carrier Packaging

#### (1) Appearance of Taping

##### ① Embossed Tape

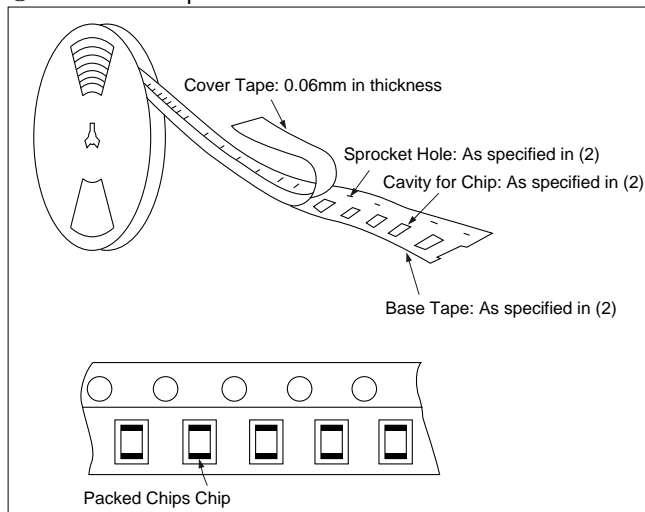

##### ② Paper Tape

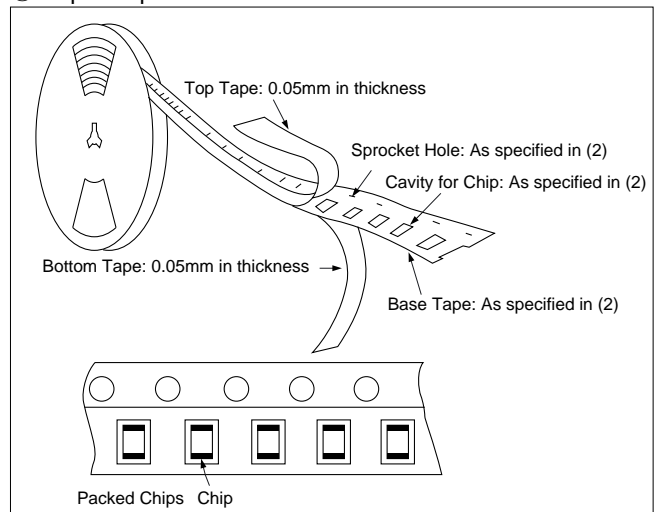

Continued on the following page. ↗

## Package

Continued from the preceding page.

### (2) Dimensions of Tape

#### ① Embossed Tape

8mm width 4mm pitch Tape

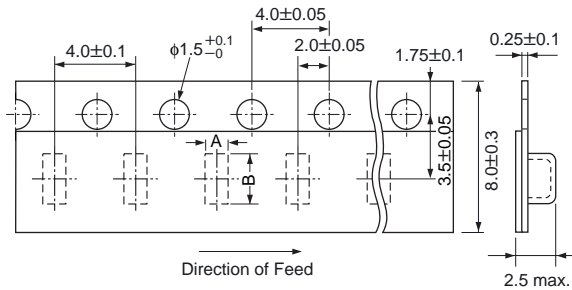

Part Number	A*	B*
<b>GRM21</b> (T≥1.25mm)	1.45	2.25
<b>GRM31/GR731</b> (T≥1.25mm)	2.0	3.6
<b>GRM32</b> (T≥1.25mm)	2.9	3.6

\*Nominal Value

12mm width 8mm/4mm pitch Tape

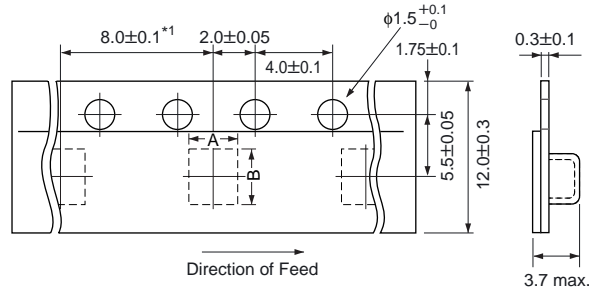

Part Number	A*	B*
<b>GRM42/GR442/GA242/GA342</b>	2.5	5.1
<b>GRM43/GR443/GA243/GA343</b>	3.6	4.9
<b>GA352</b>	3.2	6.1
<b>GRM55/GA255/GA355</b>	5.4	6.1

\*1 4.0±0.1mm in case of GRM42/GR442/GA242/GA342

\*Nominal Value

(in mm)

#### ② Paper Tape

8mm width 4mm pitch Tape

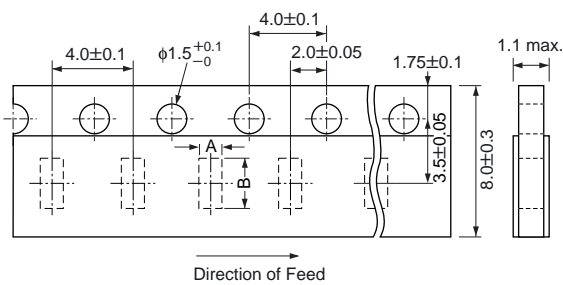

Part Number	A*	B*
<b>GRM18</b>	1.05	1.85
<b>GRM21</b> (T=1.0mm)	1.45	2.25
<b>GRM31/GR731</b> (T=1.0mm)	2.0	3.6
<b>GRM32</b> (T=1.0mm)	2.9	3.6

\*Nominal value  
(in mm)

#### (3) Dimensions of Reel

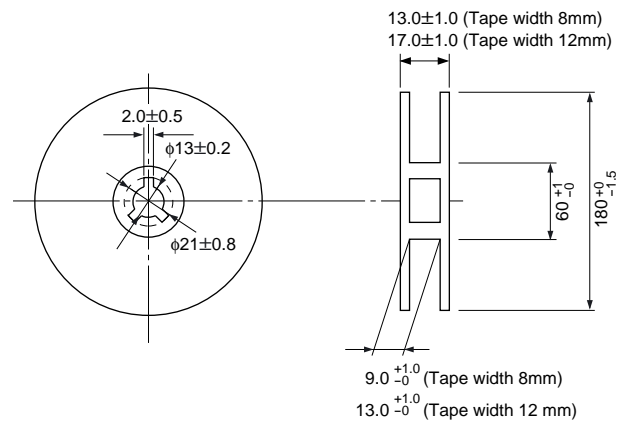

(in mm)

Continued on the following page. ↗

## Package

Continued from the preceding page.

### (4) Taping Method

- ① Tapes for capacitors are wound clockwise. The sprocket holes are to the right as the tape is pulled toward the user.
- ② Part of the leader and part of the empty tape shall be attached to the end of the tape as shown at right.
- ③ The top tape or cover tape and base tape are not attached at the end of the tape for a minimum of 5 pitches.
- ④ Missing capacitors number within 0.1% of the number per reel or 1 pc, whichever is greater, and are not continuous.
- ⑤ The top tape or cover tape and bottom tape shall not protrude beyond the edges of the tape and shall not cover sprocket holes.
- ⑥ Cumulative tolerance of sprocket holes, 10 pitches :  $\pm 0.3\text{mm}$ .
- ⑦ Peeling off force : 0.1 to 0.6N in the direction shown at right.

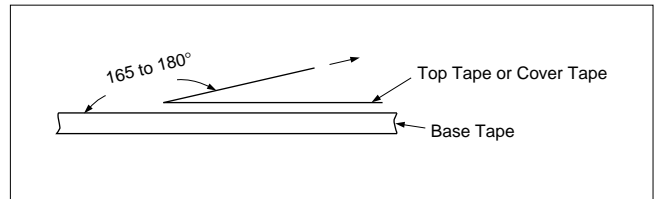
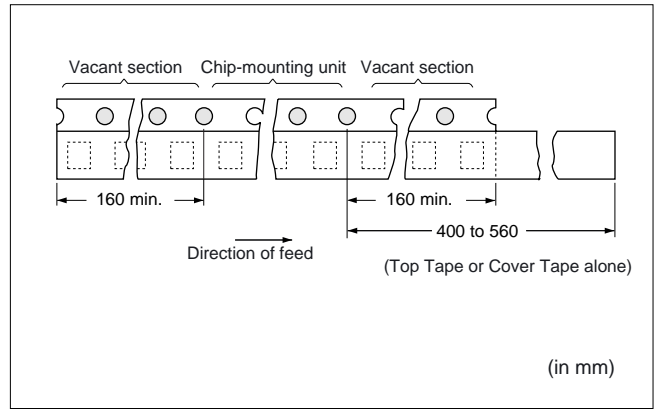



## ■ Storage and Operating Conditions

### Operating and storage environment

Do not use or store capacitors in a corrosive atmosphere, especially where chloride gas, sulfide gas, acid, alkali, salt or the like are present. And avoid exposure to moisture. Before cleaning, bonding or molding this product, verify that these processes do not affect product quality by testing the performance of a cleaned, bonded or molded product in the intended equipment. Store the capacitors

where the temperature and relative humidity do not exceed 5 to 40 degrees centigrade and 20 to 70%. Use capacitors within 6 months. Check the solderability after 6 months or more.

FAILURE TO FOLLOW THE ABOVE CAUTIONS MAY RESULT, WORST CASE, IN A SHORT CIRCUIT AND CAUSE FUMING OR PARTIAL DISPERSION WHEN THE PRODUCT IS USED.

## ■ Handling

### 1. Vibration and impact

Do not expose a capacitor to excessive shock or vibration during use.

### 2. Do not directly touch the chip capacitor, especially the ceramic body. Residue from hands/fingers may create a short circuit environment.

FAILURE TO FOLLOW THE ABOVE CAUTIONS MAY RESULT, WORST CASE, IN A SHORT CIRCUIT AND CAUSE FUMING OR PARTIAL DISPERSION WHEN THE PRODUCT IS USED.

**Caution**

**Caution (Rating)**

**1. Operating Voltage**

When DC-rated capacitors are to be used in AC or ripple current circuits, be sure to maintain the  $V_{p-p}$  value of the applied voltage or the  $V_{o-p}$  which contains DC bias within the rated voltage range.

When the voltage is applied to the circuit, starting or stopping may generate irregular voltage for a transit period because of resonance or switching. Be sure to use a capacitor with a rated voltage range that includes these irregular voltages.

Voltage	DC Voltage	DC+AC Voltage	AC Voltage	Pulse Voltage (1)	Pulse Voltage (2)
Positional Measurement					

**2. Operating Temperature and Self-generated Heat**

**(1) In case of X7R char.**

Keep the surface temperature of a capacitor below the upper limit of its rated operating temperature range. Be sure to take into account the heat generated by the capacitor itself. When the capacitor is used in a high-frequency current, pulse current or the like, it may have the self-generated heat due to dielectric-loss. Applied voltage should be the load such as self-generated heat is within 20°C on the condition of atmosphere temperature 25°C. When measuring, use a thermocouple of small thermal capacity-K of  $\phi 0.1\text{mm}$  in conditions where the capacitor is not affected by radiant heat from other components or surrounding ambient fluctuations. Excessive heat may lead to deterioration of the capacitor's characteristics and reliability. (Never attempt to perform measurement with the cooling fan running. Otherwise, accurate measurement cannot be ensured.)

**(2) In case of COG char.**

Keep the surface temperature of a capacitor below the upper limit of its rated operating temperature range. Be sure to take into account the heat generated by the capacitor itself. When the capacitor is used in a high-frequency current, pulse current or similar current, it may self-generate heat due to dielectric loss. The frequency of the applied sine wave voltage should be less than 100kHz. The applied voltage should be less than the value shown in figure at right. In case of non-sine wave which include a harmonic frequency, please contact our sales representatives or product engineers. Excessive heat may lead to deterioration of the capacitor's characteristics and reliability. (Never attempt to perform measurement with the cooling fan running. Otherwise, accurate measurement cannot be ensured.)

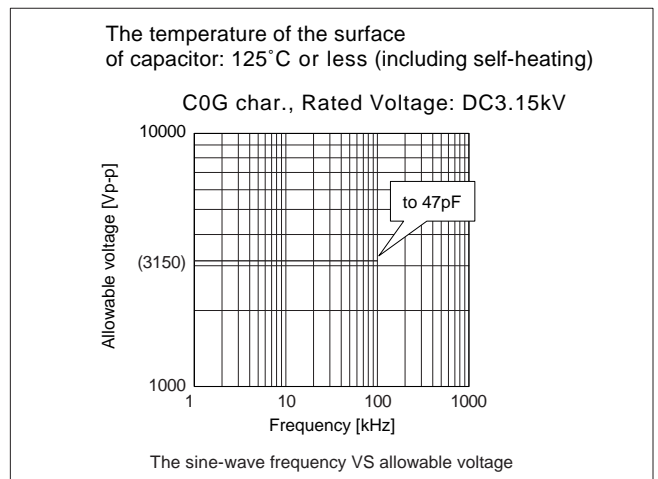

Continued on the following page.



Continued from the preceding page.

(3) In case of U2J char.

Keep the surface temperature of a capacitor below the upper limit of its rated operating temperature range.

Be sure to take into account the heat generated by the capacitor itself. When the capacitor is used in a high-frequency current, pulse current or similar current, it may self-generate heat due to dielectric loss.

The frequency of the applied sine wave voltage should be less than 500kHz (less than 100kHz in case of rated voltage: DC3.15kV). The applied voltage should be less than the value shown in figure below.

In case of non-sine wave which includes a harmonic frequency, please contact our sales representatives or product engineers. Excessive heat may lead to deterioration of the capacitor's characteristics and reliability. (Never attempt to perform measurement with the cooling fan running.

Otherwise, accurate measurement cannot be ensured.)

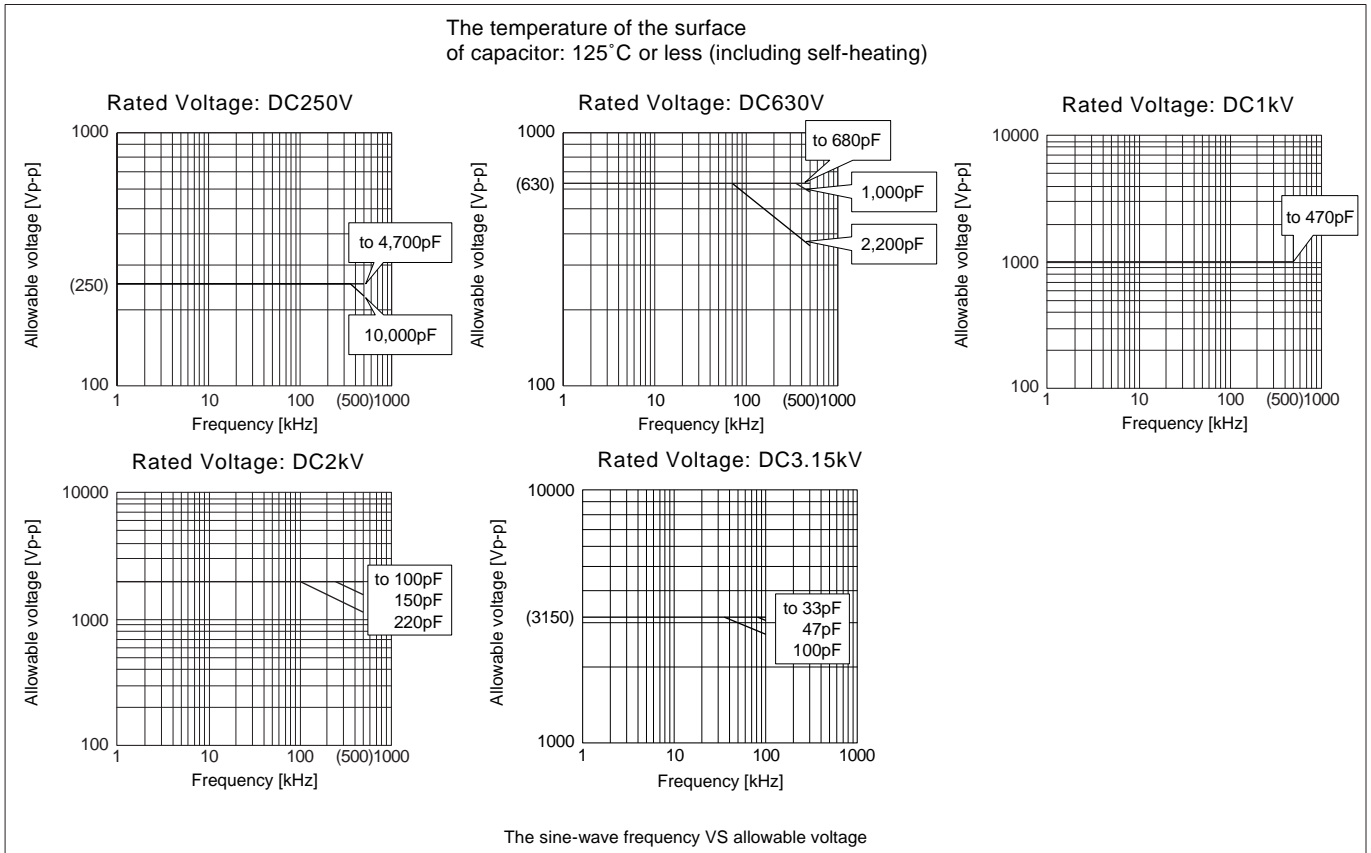

Continued on the following page. ↗

## ⚠ Caution

☐ Continued from the preceding page.

### (4) In case of GRM series SL char.

Keep the surface temperature of a capacitor below the upper limit of its rated operating temperature range.

Be sure to take into account the heat generated by the capacitor itself. When the capacitor is used in a high-frequency current, pulse current or similar current, it may self-generate heat due to dielectric loss.

The frequency of the applied sine wave voltage should be less than 500kHz. The applied voltage should be less than the value shown in figure at right.

In case of non-sine wave which include a harmonic frequency, please contact our sales representatives or product engineers. Excessive heat may lead to deterioration of the capacitor's characteristics and reliability. (Never attempt to perform measurement with the cooling fan running.

Otherwise, accurate measurement cannot be ensured.)

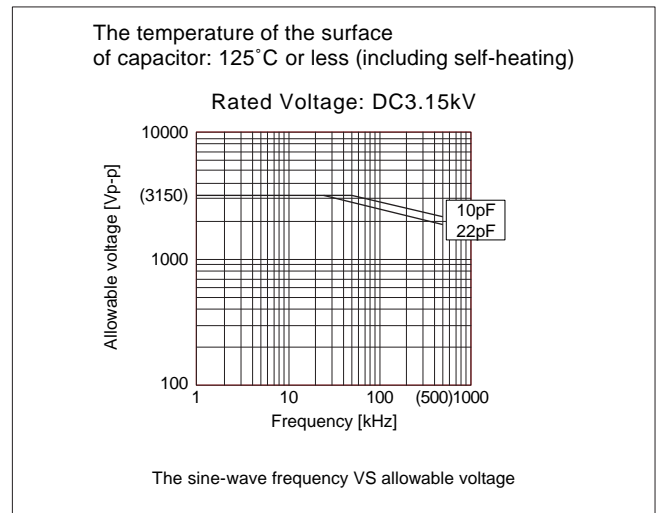

### 3. Test condition for AC withstanding Voltage

#### (1) Test Equipment

Tests for AC withstanding voltage should be made with equipment capable of creating a wave similar to a 50/60 Hz sine wave.

If the distorted sine wave or overload exceeding the specified voltage value is applied, a defect may be caused.

#### (2) Voltage applied method

The capacitor's leads or terminals should be firmly connected to the output of the withstanding voltage test equipment, and then the voltage should be raised from near zero to the test voltage. If the test voltage is applied directly to the capacitor without raising it from near zero, it should be applied with the \*zero cross. At the end of the test time, the test voltage should be reduced to near zero, and then the capacitor's leads or terminals should be taken off the output of the withstanding voltage test equipment. If the test voltage is applied directly to the capacitor without raising it from near zero, surge voltage may occur and cause a defect.

\*ZERO CROSS is the point where voltage sine wave pass 0V.

- See the figure at right -

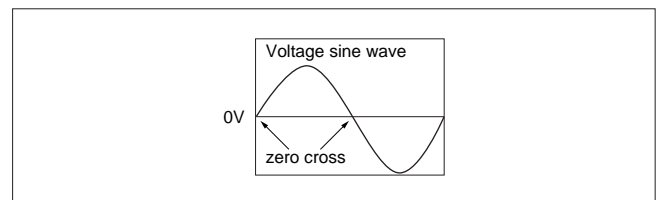

Continued on the following page. ☐



**Caution**

☐ Continued from the preceding page.

**4. Fail-safe**

Failure of a capacitor may result in a short circuit. Be sure to provide an appropriate fail-safe function such as a fuse on your product to help eliminate possible electric shock, fire, or fumes.

Please consider using fuses on each AC line if the capacitors are used between the AC input lines and earth (line bypass capacitors), to prepare for the worst case, such as a short circuit.

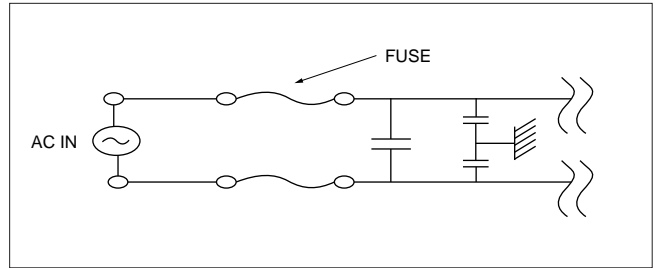

**FAILURE TO FOLLOW THE ABOVE CAUTIONS MAY RESULT, WORST CASE, IN A SHORT CIRCUIT AND CAUSE FUMING OR PARTIAL DISPERSION WHEN THE PRODUCT IS USED.**

## ⚠ Caution

### ■ Caution (Soldering and Mounting)

#### 1. Vibration and Impact

Do not expose a capacitor to excessive shock or vibration during use.

#### 3. Land Layout for Cropping PC Board

Choose a mounting position that minimizes the stress imposed on the chip during flexing or bending of the board.

[Component Direction]

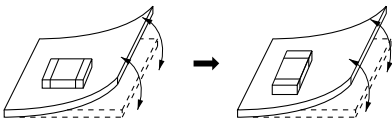

Locate chip horizontal to the direction in which stress acts.

[Chip Mounting Close to Board Separation Point]

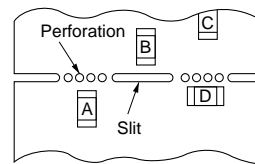

Chip arrangement  
Worst A>C>B~D Best

#### 4. Soldering

If a chip component is heated or cooled abruptly during soldering, it may crack due to the thermal shock. To prevent this, follow our recommendations below for adequate soldering conditions. Carefully perform pre-heating so that temperature difference ( $\Delta T$ ) between the solder and component surface is in the following range. The smaller the temperatures difference ( $\Delta T$ ) between the solder and component surface is, the smaller the influence on the chip is. When components are immersed in solvent after mounting, please set the slow cooling process to keep the temperature difference within 100°C.

Chip Size	3.2×1.6mm and under	3.2×2.5mm and over
Soldering Method		
Reflow Method or Soldering Iron Method	$\Delta T \leq 190^\circ\text{C}$	$\Delta T \leq 130^\circ\text{C}$
Flow Method or Dip Soldering Method	$\Delta T \leq 150^\circ\text{C}$	—

#### 5. Soldering Iron

When soldering chips with a soldering iron, it should be performed in following conditions.

And pre-heating shown in clause 4.

Item	Conditions	
Chip Size	$\leq 2.0 \times 1.25\text{mm}$	$\geq 3.2 \times 1.6\text{mm}$
Temperature of Iron tip	300°C max.	270°C max.
Soldering Iron Wattage	20W max.	
Diameter of Iron tip	$\phi 3.0\text{mm}$ max.	
Soldering Time	3 sec. max.	
Caution	Do not allow the iron tip to directly touch the ceramic element.	

FAILURE TO FOLLOW THE ABOVE CAUTIONS MAY RESULT, WORST CASE, IN A SHORT CIRCUIT AND CAUSE FUMING OR PARTIAL DISPERSION WHEN THE PRODUCT IS USED.

**Notice**

**■ Notice (Soldering and Mounting)**

**1. Construction of Board Pattern**

After installing chips, if solder is excessively applied to the circuit board, mechanical stress will cause destruction resistance characteristics to lower. To prevent this, be extremely careful in determining shape and dimension before designing the circuit board diagram.

**Construction and Dimensions of Pattern (Example)**

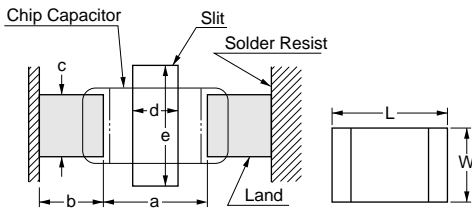

Preparing slit helps flux cleaning and resin coating on the back of the capacitor.

**Flow Soldering**

L×W	a	b	c
1.6×0.8	0.6-1.0	0.8-0.9	0.6-0.8
2.0×1.25	1.0-1.2	0.9-1.0	0.8-1.1
3.2×1.6	2.2-2.6	1.0-1.1	1.0-1.4

Flow soldering : 3.2×1.6 or less available.

**Reflow Soldering**

L×W	a	b	c	d	e
1.6×0.8	0.6-0.8	0.6-0.7	0.6-0.8	-	-
2.0×1.25	1.0-1.2	0.9-1.0	0.8-1.1	-	-
3.2×1.6	2.2-2.4	0.8-0.9	1.0-1.4	1.0-2.0	3.2-3.7
3.2×2.5	2.0-2.4	1.0-1.2	1.8-2.3	1.0-2.0	4.1-4.6
4.5×2.0	2.8-3.4	1.2-1.4	1.4-1.8	1.0-2.8	3.6-4.1
4.5×3.2	2.8-3.4	1.2-1.4	2.3-3.0	1.0-2.8	4.8-5.3
5.7×2.8	4.0-4.6	1.4-1.6	2.1-2.6	1.0-4.0	4.4-4.9
5.7×5.0	4.0-4.6	1.4-1.6	3.5-4.8	1.0-4.0	6.6-7.1

(in mm)

**Land Layout to Prevent Excessive Solder**

	Mounting Close to a Chassis	Mounting with Leaded Components	Mounting Leaded Components Later
Examples of Arrangements to be Avoided			
Examples of Improvements by the Land Division			

Continued on the following page.

## Notice

☐ Continued from the preceding page.

### 2. Mounting of Chips

#### ● Thickness of adhesives applied

Keep thickness of adhesives applied (50-105 $\mu$ m or more) to reinforce the adhesive contact considering the thickness of the termination or capacitor (20-70 $\mu$ m) and the land pattern (30-35 $\mu$ m).

#### ● Mechanical shock of the chip placer

When the positioning claws and pick-up nozzle are worn, the load is applied to the chip while positioning is concentrated in one position, thus causing cracks, breakage, faulty positioning accuracy, etc.

Careful checking and maintenance are necessary to prevent unexpected trouble.

An excessively low bottom dead point of the suction nozzle imposes great force on the chip during mounting, causing cracked chips. Please set the suction nozzle's bottom dead point on the upper surface of the board.

### 3. Soldering

#### (1) Limit of losing effective area of the terminations and conditions needed for soldering.

Depending on the conditions of the soldering temperature and/or immersion (melting time), effective areas may be lost in some part of the terminations.

To prevent this, be careful in soldering so that any possible loss of the effective area on the terminations will securely remain at a maximum of 25% on all edge length A-B-C-D-A of part with A, B, C, D, shown in the Figure below.

In case of repeated soldering, the accumulated soldering time must be within the range shown at right.

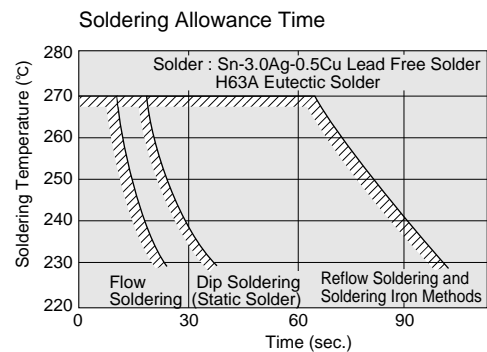
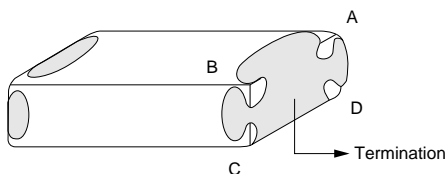

#### (2) Flux

● Please use it after confirming there is no problem in the reliability of the product beforehand with a intended equipment. The residue of flux might cause the decrease in nonconductivity and the corrosion of an external electrode, etc.

#### (3) Solder Amount

##### ① Flow soldering and iron soldering

Use as little solder as possible, and confirm that the solder is securely placed.

Continued on the following page. ☐

☐ Continued from the preceding page.

② Reflow soldering

When soldering, confirm that the solder is placed over 0.2mm of the surface of the terminations.

4. Cleaning

Please confirm there is no problem in the reliability of the product beforehand when cleaning it with a intended equipment.

The residue after it cleaning it might cause the decrease in the surface resistance of the chip and the corrosion of the electrode part, etc. As a result might cause reliability to deteriorate. Please confirm there is no problem with a intended equipment in the ultrasonic cleansing beforehand.

5. Resin Coating

Please use it after confirming there is no influence on the product with a intended equipment beforehand when the resin coating and molding.

The chip crack might be caused at the cool and heat cycle by bias of the amount of spreading of the resin and spreading thickness.

The resin for the coating and molding must use the thing that as the stress when stiffening is small, and the hygroscopic is as low as possible.

■ Rating

1. Capacitance change of capacitor

(1) In case of X7R char.

Capacitors have an aging characteristic, whereby the capacitor continually decreases its capacitance slightly if the capacitor is left on for a long time. Moreover, capacitance might change greatly depending on the surrounding temperature or an applied voltage. So, it is not likely to be suitable for use in a time constant circuit.

Please contact us if you need detailed information.

(2) In case of any char. except X7R

Capacitance might change a little depending on the surrounding temperature or an applied voltage.

Please contact us if you intend to use this product in a strict time constant circuit.

2. Performance check by equipment

Before using a capacitor, check that there is no problem in the equipment's performance and the specifications.

Generally speaking, CLASS 2 (X7R char.) ceramic capacitors have voltage dependence characteristics and temperature dependence characteristics in capacitance. So, the capacitance value may change depending on the operating condition in a equipment. Therefore, be sure to confirm the apparatus performance of receiving influence in a capacitance value change of a capacitor, such as leakage current and noise suppression characteristic.

Moreover, check the surge-proof ability of a capacitor in the equipment, if needed, because the surge voltage may exceed specific value by the inductance of the circuit.

## ISO 9001 Certifications

### ■ Qualified Standards

The products listed here have been produced by ISO 9001 certified factory.

Plant
Fukui Murata Mfg. Co., Ltd.
Izumo Murata Mfg. Co., Ltd.
Okayama Murata Mfg. Co., Ltd.
Murata Electronics Singapore (Pte.) Ltd.
Murata Amazonia Industria E Comercio Ltda.
Suzhou Murata Electronics Co., Ltd.
Beijing Murata Electronics Co., Ltd.

**△Note:**

**1. Export Control**

〈For customers outside Japan〉

No muRata products should be used or sold, through any channels, for use in the design, development, production, utilization, maintenance or operation of, or otherwise contribution to (1) any weapons (Weapons of Mass Destruction (nuclear, chemical or biological weapons or missiles) or conventional weapons) or (2) goods or systems specially designed or intended for military end-use or utilization by military end-users.

〈For customers in Japan〉

For products which are controlled items subject to the "Foreign Exchange and Foreign Trade Law" of Japan, the export license specified by the law is required for export.

**2. Please contact our sales representatives or product engineers before using the products in this catalog for the applications listed below, which require especially high reliability for the prevention of defects which might directly damage a third party's life, body or property, or when one of our products is intended for use in applications other than those specified in this catalog.**

- |                             |                                                                                                      |
|-----------------------------|------------------------------------------------------------------------------------------------------|
| ① Aircraft equipment        | ② Aerospace equipment                                                                                |
| ③ Undersea equipment        | ④ Power plant equipment                                                                              |
| ⑤ Medical equipment         | ⑥ Transportation equipment (vehicles, trains, ships, etc.)                                           |
| ⑦ Traffic signal equipment  | ⑧ Disaster prevention / crime prevention equipment                                                   |
| ⑨ Data-processing equipment | ⑩ Application of similar complexity and/or reliability requirements to the applications listed above |

**3. Product specifications in this catalog are as of July 2005. They are subject to change or our products in it may be discontinued without advance notice. Please check with our sales representatives or product engineers before ordering. If there are any questions, please contact our sales representatives or product engineers.**

**4. Please read rating and △CAUTION (for storage, operating, rating, soldering, mounting and handling) in this catalog to prevent smoking and/or burning, etc.**

**5. This catalog has only typical specifications because there is no space for detailed specifications. Therefore, please approve our product specifications or transact the approval sheet for product specifications before ordering.**

**6. Please note that unless otherwise specified, we shall assume no responsibility whatsoever for any conflict or dispute that may occur in connection with the effect of our and/or a third party's intellectual property rights and other related rights in consideration of your use of our products and/or information described or contained in our catalogs. In this connection, no representation shall be made to the effect that any third parties are authorized to use the rights mentioned above under licenses without our consent.**

**7. No ozone depleting substances (ODS) under the Montreal Protocol are used in our manufacturing process.**