

PLASTIC-ENCAPSULATE VOLTAGE REGULATORS

FEATURES

- Maximum Output Current I_o : 1.5A
- Output Voltage V_o : -5,-6,-8,-9,-10,-12,-15,-18,-20,-24 V
- Continuous Total Dissipation
 P_D : 1.25 W ($T_a = 25\text{ }^\circ\text{C}$)
- Surface Mount device

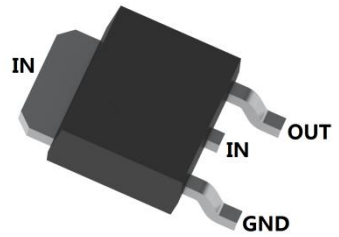

SCHEMATIC DIAGRAM

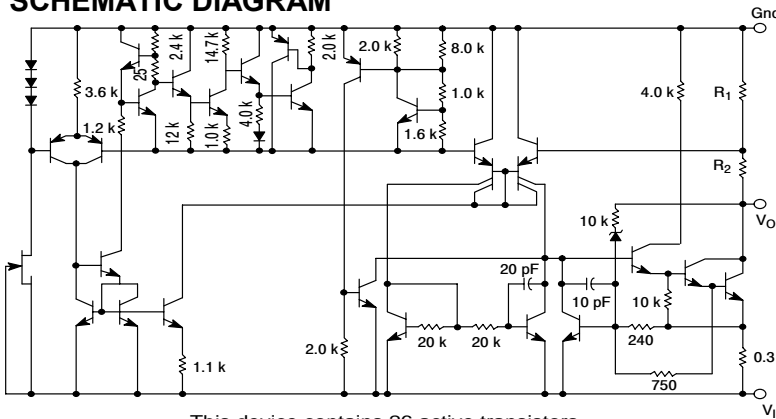

This device contains 26 active transistors.

TO-252

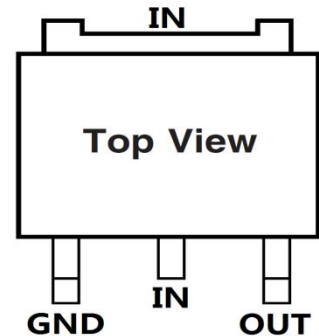

MECHANICAL DATA

- Case: TO-252
- Case Material: Molded Plastic. UL flammability
- Classification Rating: 94V-0
- Weight: 0.055 grams (approximate)

MAXIMUM RATINGS (Operating temperature range applies unless otherwise specified)

Parameter	Symbol	Value	Unit	
Input Voltage	V_i	$V_o = -5 \sim -18V$	-35	V
		$V_o = -20 \sim -24V$	-40	V
Total Dissipation	P_D	Internally Limited	W	
Thermal Resistance from Junction to Ambient	$R_{\theta JA}$	65	$^\circ\text{C}/\text{W}$	
Thermal Resistance from Junction to Case	$R_{\theta JC}$	5.0	$^\circ\text{C}/\text{W}$	
Operating Temperature	T_{opr}	$0 \sim +125$	$^\circ\text{C}$	
Storage Temperature Range	T_{STG}	$-65 \sim +125$	$^\circ\text{C}$	

TEST CIRCUIT(Typical Applications)

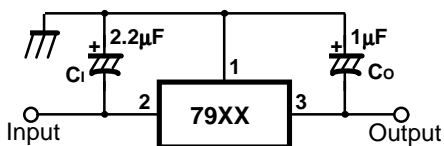
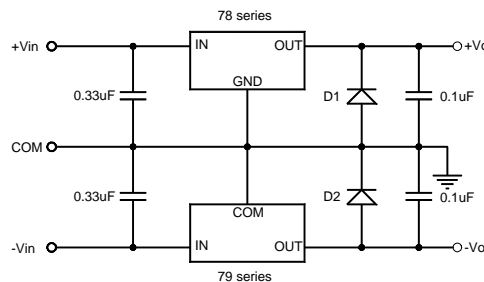

Figure 1. Negative Fixed output regulator



Note : In the above positive and negative power supply application, D1 and D2 should be connected. If D1 and D2 are not connected, either of positive or negative power supply circuit may not turns on.

Figure 2. Positive/Negative Voltage Supply

Notes:

- (1) To specify an output voltage, substitute voltage value for "XX "
- (2) Required for stability. For value given, capacitor must be solid tantalum. If aluminium electronics are used, at least ten times value shown should be selected. C_1 is required if regulator is located an appreciable distance from power supply filter.
- (3) To improve transient response. If large capacitors are used, a high current diode from input to output (1N4001 or similar) should be introduced to protect the device from momentary input short circuit.

PLASTIC-ENCAPSULATE VOLTAGE REGULATORS
**ELECTRICAL CHARACTERISTICS OF 7905 AT SPECIFIED VIRTUAL JUNCTION TEMPERATURE
($V_i=-10V, I_o=-500mA, C_i=2.2\mu F, C_o=1\mu F, 0^\circ C \leq T_J \leq +125^\circ C$ unless otherwise specified)**

Parameter	Symbol	Min	Typ	Max	Unit	Conditions
Output voltage	V_o	-4.80	-5.0	-5.20	V	$T_J=+25^\circ C$
		-4.75	-5.0	-5.25	V	$-8V \leq V_i \leq -20V, I_o=5mA \sim 1A, P_o \leq 15W$
Line regulation(NOTE1)	ΔV_o			100	mV	$-7V \leq V_i \leq -25V, T_J=+25^\circ C$
				50	mV	$-8V \leq V_i \leq -12V, T_J=+25^\circ C$
Load Regulation(NOTE1)	ΔV_o			100	mV	$I_o=5mA \sim 1.5A, T_J=+25^\circ C$
				50	mV	$I_o=250mA \sim 750mA, T_J=+25^\circ C$
Quiescent Current	I_q			3	mA	$T_J=+25^\circ C$
Quiescent Current Change	ΔI_q			1.3	mA	$-8V \leq V_i \leq -25V$
				0.5	mA	$5mA \leq I_o \leq 1A$
Output Noise Voltage	V_N		100		μV	$10Hz \leq f \leq 100kHz, T_J=+25^\circ C$
Ripple Rejection	RR	54	60		dB	$\Delta V_i=10V, f=120Hz$
Dropout Voltage	V_D		1.4		V	$T_J=+25^\circ C, I_o=1A, \Delta V_o=100mV$
Short Circuit Current	I_{sc}		2.1		A	
Peak Current	I_{pk}		2.5		A	$T_J=+25^\circ C$
Temperature Coefficient of V_D	$\Delta V_o/\Delta T$		-0.4		$mV/^\circ C$	$I_o=5mA$

Note:1. Load and line regulation are specified at constant junction temperature. Change in V_o due to heating effects must be taken into account separately. Pulse testing with low duty is used.

**ELECTRICAL CHARACTERISTICS OF 7906 AT SPECIFIED VIRTUAL JUNCTION TEMPERATURE
($V_i=-11V, I_o=-500mA, C_i=2.2\mu F, C_o=1\mu F, 0^\circ C \leq T_J \leq +125^\circ C$ unless otherwise specified)**

Parameter	Symbol	Min	Typ	Max	Unit	Conditions
Output voltage	V_o	-5.75	-6.0	-6.25	V	$T_J=+25^\circ C$
		-5.7	-6.0	-6.3	V	$-9.5V \leq V_i \leq -21.5V, I_o=5mA \sim 1A, P_o \leq 15W$
Line regulation(NOTE1)	ΔV_o			120	mV	$-8.5V \leq V_i \leq -25V$
				60	mV	$-9V \leq V_i \leq -15V, T_J=+25^\circ C$
Load Regulation(NOTE1)	ΔV_o			120	mV	$I_o=5mA \sim 1.5A, T_J=+25^\circ C$
				60	mV	$I_o=250mA \sim 750mA, T_J=+25^\circ C$
Quiescent Current	I_q			3	mA	$T_J=+25^\circ C$
Quiescent Current Change	ΔI_q			1.3	mA	$-9.5V \leq V_i \leq -25V$
				0.5	mA	$5mA \leq I_o \leq 1A$
Output Noise Voltage	V_N		144		μV	$10Hz \leq f \leq 100kHz, T_A=+25^\circ C$
Ripple Rejection	RR	54	60		dB	$\Delta V_i=10V, f=120Hz,$
Dropout Voltage	V_d		1.4		V	$T_J=+25^\circ C, I_o=1A, \Delta V_o=100mV$
Short Circuit Current	I_{sc}		2		A	
Peak Current	I_{pk}		2.5		A	$T_J=+25^\circ C$
Temperature Coefficient of V_D	$\Delta V_o/\Delta T$		-0.6		$mV/^\circ C$	$I_o=5mA$

Note:1. Load and line regulation are specified at constant junction temperature. Change in V_o due to heating effects must be taken into account separately. Pulse testing with low duty is used.

PLASTIC-ENCAPSULATE VOLTAGE REGULATORS
**ELECTRICAL CHARACTERISTICS OF 7908 AT SPECIFIED VIRTUAL JUNCTION TEMPERATURE
($V_i=-14V, I_o=500mA, C_i=2.2\mu F, C_o=1\mu F, 0^\circ C \leq T_J \leq +125^\circ C$ unless otherwise specified)**

Parameter	Symbol	Min	Typ	Max	Unit	Conditions
Output voltage	V_o	-7.7	-8.0	-8.3	V	$T_J=+25^\circ C$
		-7.6	-8.0	-8.4	V	$-11.5V \leq V_i \leq -23V, I_o=5mA \sim 1A, P_o \leq 15W$
Line regulation(NOTE1)	ΔV_o			160	mV	$-10.5V \leq V_i \leq -25V, T_J=+25^\circ C$
				80	mV	$-11V \leq V_i \leq -17V, T_J=+25^\circ C$
Load Regulation(NOTE1)	ΔV_o			160	mV	$I_o=5mA \sim 1.5A, T_J=+25^\circ C$
				80	mV	$I_o=250mA \sim 750mA, T_J=+25^\circ C$
Quiescent Current	I_q			3	mA	$T_J=+25^\circ C$
Quiescent Current Change	ΔI_q			1.3	mA	$-11.5V \leq V_i \leq -25V$
				0.5	mA	$5mA \leq I_o \leq 1A$
Output Noise Voltage	V_N		175		μV	$10Hz \leq f \leq 100kHz, T_J=+25^\circ C$
Ripple Rejection	RR	54	60		dB	$\Delta V_i=10V, f=120Hz$
Dropout Voltage	V_d		1.1		V	$I_o=1A, \Delta V_o=100mV, T_J=+25^\circ C$
Short Circuit Current	I_{sc}		1.5		A	
Peak Current	I_{pk}		2.5		A	$T_J=+25^\circ C$
Temperature Coefficient of V_D	$\Delta V_o/\Delta T$		-0.6		$mV/^\circ C$	$I_o=5mA$

Note:1. Load and line regulation are specified at constant junction temperature. Change in V_o due to heating effects must be taken into account separately. Pulse testing with low duty is used.

**ELECTRICAL CHARACTERISTICS OF 7909 AT SPECIFIED VIRTUAL JUNCTION TEMPERATURE
($V_i=-15V, I_o=500mA, C_i=2.2\mu F, C_o=1\mu F, 0^\circ C \leq T_J \leq +125^\circ C$ unless otherwise specified)**

Parameter	Symbol	Min	Typ	Max	Unit	Conditions
Output voltage	V_o	-8.7	-9.0	-9.3	V	$T_J=+25^\circ C$
		-8.6	-9.0	-9.4	V	$-11.5V \leq V_i \leq -24V, I_o=5mA \sim 1A, P_o \leq 15W$
Line regulation(NOTE1)	ΔV_o			180	mV	$-11.5V \leq V_i \leq -26V, T_J=+25^\circ C$
				90	mV	$-13V \leq V_i \leq -19V, T_J=+25^\circ C$
Load Regulation(NOTE1)	ΔV_o			180	mV	$I_o=5mA \sim 1.5A, T_J=+25^\circ C$
				90	mV	$I_o=250mA \sim 750mA, T_J=+25^\circ C$
Quiescent Current	I_q			3	mA	$T_J=+25^\circ C$
Quiescent Current Change	ΔI_q			1.3	mA	$-11.5V \leq V_i \leq -26V$
				0.5	mA	$5mA \leq I_o \leq 1A$
Output Noise Voltage	V_N		175		μV	$10Hz \leq f \leq 100kHz, T_J=+25^\circ C$
Ripple Rejection	RR	54	60		dB	$\Delta V_i=10V, f=120Hz$
Dropout Voltage	V_D		1.1		V	$I_o=1A, \Delta V_o=100mV, T_J=+25^\circ C$
Short Circuit Current	I_{sc}		1.5		A	
Peak Current	I_{pk}		2.5		A	$T_J=+25^\circ C$
Temperature Coefficient of V_D	$\Delta V_o/\Delta T$		-0.6		$mV/^\circ C$	$I_o=5mA$

Note:1. Load and line regulation are specified at constant junction temperature. Change in V_o due to heating effects must be taken into account separately. Pulse testing with low duty is used.

PLASTIC-ENCAPSULATE VOLTAGE REGULATORS
**ELECTRICAL CHARACTERISTICS OF 7910 AT SPECIFIED VIRTUAL JUNCTION TEMPERATURE
($V_i=-17V, I_o=500mA, C_i=2.2\mu F, C_o=1\mu F, 0^\circ C \leq T_J \leq +125^\circ C$ unless otherwise specified)**

Parameter	Symbol	Min	Typ	Max	Unit	Conditions
Output voltage	V_o	-9.6	-10	-10.4	V	$T_J=+25^\circ C$
		-9.5	-10	-10.5	V	$-12V \leq V_i \leq -28V, I_o=5mA \sim 1A, P_o \leq 15W$
Line regulation(NOTE1)	ΔV_o			200	mV	$-12.5V \leq V_i \leq -28V, T_J=+25^\circ C$
				100	mV	$-14V \leq V_i \leq -20V, T_J=+25^\circ C$
Load Regulation(NOTE1)	ΔV_o			200	mV	$I_o=5mA \sim 1.5A, T_J=+25^\circ C$
				100	mV	$I_o=250mA \sim 750mA, T_J=+25^\circ C$
Quiescent Current	I_q			3	mA	$T_J=+25^\circ C$
Quiescent Current Change	ΔI_q			1	mA	$-12.5V \leq V_i \leq -28V, T_J=+25^\circ C$
				0.5	mA	$5mA \leq I_o \leq 1A, T_J=+25^\circ C$
Output Noise Voltage	V_N		280		μV	$10Hz \leq f \leq 100kHz, T_A=+25^\circ C$
Ripple Rejection	RR	54	60		dB	$\Delta V_i=10V, f=120Hz$
Dropout Voltage	V_D		1.1		V	$I_o=1A, \Delta V_o=100mV, T_J=+25^\circ C$
Short Circuit Current	I_{sc}		1.5		A	
Peak Current	I_{pk}		2.5		A	$T_J=+25^\circ C$
Temperature Coefficient of V_D	$\Delta V_o/\Delta T$		-0.8		$mV/^\circ C$	$I_o=5mA$

Note:1. Load and line regulation are specified at constant junction temperature. Change in V_o due to heating effects must be taken into account separately. Pulse testing with low duty is used.

**ELECTRICAL CHARACTERISTICS OF 7912 AT SPECIFIED VIRTUAL JUNCTION TEMPERATURE
($V_i=-19V, I_o=500mA, C_i=2.2\mu F, C_o=1\mu F, 0^\circ C \leq T_J \leq +125^\circ C$ unless otherwise specified)**

Parameter	Symbol	Min	Typ	Max	Unit	Conditions
Output voltage	V_o	-11.5	-12	-12.5	V	$T_J=+25^\circ C$
		-11.4	-12	-12.6	V	$-15.5V \leq V_i \leq -27V, I_o=5mA \sim 1A, P_o \leq 15W$
Line regulation(NOTE1)	ΔV_o			240	mV	$-14.5V \leq V_i \leq -30V, T_J=+25^\circ C$
				120	mV	$-16V \leq V_i \leq -22V, T_J=+25^\circ C$
Load Regulation(NOTE1)	ΔV_o			240	mV	$I_o=5mA \sim 1.5A, T_J=+25^\circ C$
				120	mV	$I_o=250mA \sim 750mA, T_J=+25^\circ C$
Quiescent Current	I_q			3	mA	$T_J=+25^\circ C$
Quiescent Current Change	ΔI_q			1	mA	$-15V \leq V_i \leq -30V$
				0.5	mA	$5mA \leq I_o \leq 1A$
Output Noise Voltage	V_N		200		μV	$10Hz \leq f \leq 100kHz, T_J=+25^\circ C$
Ripple Rejection	RR	54	60		dB	$\Delta V_i=10V, f=120Hz$
Dropout Voltage	V_d		1.1		V	$I_o=1A, \Delta V_o=100mV, T_J=+25^\circ C$
Short Circuit Current	I_{sc}		1.5		A	
Peak Current	I_{pk}		2.5		A	$T_J=+25^\circ C$
Temperature Coefficient of V_D	$\Delta V_o/\Delta T$		-0.8		$mV/^\circ C$	$I_o=5mA$

Note:1. Load and line regulation are specified at constant junction temperature. Change in V_o due to heating effects must be taken into account separately. Pulse testing with low duty is used.

PLASTIC-ENCAPSULATE VOLTAGE REGULATORS
**ELECTRICAL CHARACTERISTICS OF 7915 AT SPECIFIED VIRTUAL JUNCTION TEMPERATURE
($V_i=-23V, I_o=500mA, C_i=2.2\mu F, C_o=1\mu F, 0^\circ C \leq T_J \leq +125^\circ C$ unless otherwise specified)**

Parameter	Symbol	Min	Typ	Max	Unit	Conditions
Output voltage	V_o	-14.4	-15	-15.6	V	$T_J=+25^\circ C$
		-14.3	-15	-15.7	V	$-18.5V \leq V_i \leq -30V, I_o=5mA \sim 1A, P_o \leq 15W$
Line regulation(NOTE1)	ΔV_o			300	mV	$-17.5V \leq V_i \leq -30V, T_J=+25^\circ C$
				150	mV	$-20V \leq V_i \leq -26V, T_J=+25^\circ C$
Load Regulation(NOTE1)	ΔV_o			300	mV	$I_o=5mA \sim 1.5A, T_J=+25^\circ C$
				150	mV	$I_o=250mA \sim 750mA, T_J=+25^\circ C$
Quiescent Current	I_q			3	mA	$T_J=+25^\circ C$
Quiescent Current Change	ΔI_q			1	mA	$-18.5V \leq V_i \leq -30V$
				0.5	mA	$5mA \leq I_o \leq 1A$
Output Noise Voltage	V_N		250		μV	$10Hz \leq f \leq 100kHz, T_J=+25^\circ C$
Ripple Rejection	RR	54	60		dB	$\Delta V_i=10V, f=120Hz$
Dropout Voltage	V_d		1.1		V	$I_o=1A, \Delta V_o=100mV, T_J=+25^\circ C$
Short Circuit Current	I_{sc}		1.3		A	
Peak Current	I_{pk}		2.2		A	$T_J=+25^\circ C$
Temperature Coefficient of V_o	$\Delta V_o/\Delta T$		-0.9		$mV/^\circ C$	$I_o=5mA$

Note:1. Load and line regulation are specified at constant junction temperature. Change in V_o due to heating effects must be taken into account separately. Pulse testing with low duty is used.

**ELECTRICAL CHARACTERISTICS OF 7918 AT SPECIFIED VIRTUAL JUNCTION TEMPERATURE
($V_i=-27V, I_o=500mA, C_i=2.2\mu F, C_o=1\mu F, 0^\circ C \leq T_J \leq +125^\circ C$ unless otherwise specified)**

Parameter	Symbol	Min	Typ	Max	Unit	Conditions
Output voltage	V_o	-17.3	-18	-18.7	V	$T_J=+25^\circ C$
		-17.1	-18	-18.9	V	$-22V \leq V_i \leq -33V, I_o=5mA \sim 1A, P_o \leq 15W$
Line regulation(NOTE1)	ΔV_o			360	mV	$-21V \leq V_i \leq -33V, T_J=+25^\circ C$
				180	mV	$-24V \leq V_i \leq -30V, T_J=+25^\circ C$
Load Regulation(NOTE1)	ΔV_o			360	mV	$I_o=5mA \sim 1.5A, T_J=+25^\circ C$
				180	mV	$I_o=250mA \sim 750mA, T_J=+25^\circ C$
Quiescent Current	I_q			3	mA	$T_J=+25^\circ C$
Quiescent Current Change	ΔI_q			1	mA	$-22V \leq V_i \leq -33V$
				0.5	mA	$5mA \leq I_o \leq 1A$
Output Noise Voltage	V_N		300		μV	$10Hz \leq f \leq 100kHz, T_J=+25^\circ C$
Ripple Rejection	RR	54	60		dB	$\Delta V_i=10V, f=120Hz$
Dropout Voltage	V_d		1.1		V	$I_o=1A, \Delta V_o=100mV, T_J=+25^\circ C$
Short Circuit Current	I_{sc}		1.1		A	
Peak Current	I_{pk}		2.2		A	$T_J=+25^\circ C$
Temperature Coefficient of V_o	$\Delta V_o/\Delta T$		-1		$mV/^\circ C$	$I_o=5mA$

Note:1. Load and line regulation are specified at constant junction temperature. Change in V_o due to heating effects must be taken into account separately. Pulse testing with low duty is used.

PLASTIC-ENCAPSULATE VOLTAGE REGULATORS
**ELECTRICAL CHARACTERISTICS OF 7920 AT SPECIFIED VIRTUAL JUNCTION TEMPERATURE
($V_i=-29V, I_o=500mA, C_i=2.2\mu F, C_o=1\mu F, 0^\circ C \leq T_J \leq +125^\circ C$ unless otherwise specified)**

Parameter	Symbol	Min	Typ	Max	Unit	Conditions
Output voltage	V_o	-19.2	-20	-20.8	V	$T_J=+25^\circ C$
		-19.0	-20	-21.0	V	$-24V \leq V_i \leq -35V, I_o=5mA \sim 1A, P_o \leq 15W$
Line regulation(NOTE1)	ΔV_o			400	mV	$-23V \leq V_i \leq -35V, T_J=+25^\circ C$
				200	mV	$-26V \leq V_i \leq -32V, T_J=+25^\circ C$
Load Regulation(NOTE1)	ΔV_o			400	mV	$I_o=5mA \sim 1.5A, T_J=+25^\circ C$
				200	mV	$I_o=250mA \sim 750mA, T_J=+25^\circ C$
Quiescent Current	I_q			3	mA	$T_J=+25^\circ C$
Quiescent Current Change	ΔI_q			1	mA	$-24V \leq V_i \leq -35V$
				0.5	mA	$5mA \leq I_o \leq 1A$
Output Noise Voltage	V_N		350		μV	$10Hz \leq f \leq 100kHz, T_J=+25^\circ C$
Ripple Rejection	RR	54	60		dB	$\Delta V_i=10V, f=120Hz$
Dropout Voltage	V_D		1.1		V	$I_o=1A, \Delta V_o=100mV, T_J=+25^\circ C$
Short Circuit Current	I_{sc}		0.9		A	
Peak Current	I_{pk}		2.5		A	$T_J=+25^\circ C$
Temperature Coefficient of V_D	$\Delta V_o/\Delta T$		-1.1		$mV/^\circ C$	$I_o=5mA$

Note:1. Load and line regulation are specified at constant junction temperature. Change in V_o due to heating effects must be taken into account separately. Pulse testing with low duty is used.

**ELECTRICAL CHARACTERISTICS OF 7924 AT SPECIFIED VIRTUAL JUNCTION TEMPERATURE
($V_i=-33V, I_o=500mA, C_i=2.2\mu F, C_o=1\mu F, 0^\circ C \leq T_J \leq +125^\circ C$ unless otherwise specified)**

Parameter	Symbol	Min	Typ	Max	Unit	Conditions
Output voltage	V_o	-23.0	-24	-25.0	V	$T_J=+25^\circ C$
		-22.8	-24	-25.2	V	$-27V \leq V_i \leq -38V, I_o=5mA \sim 1A, P_o \leq 15W$
Line regulation(NOTE1)	ΔV_o			480	mV	$-27V \leq V_i \leq -38V, T_J=+25^\circ C$
				180	mV	$-30V \leq V_i \leq -36V, T_J=+25^\circ C$
Load Regulation(NOTE1)	ΔV_o			480	mV	$I_o=5mA \sim 1.5A, T_J=+25^\circ C$
				240	mV	$I_o=250mA \sim 750mA, T_J=+25^\circ C$
Quiescent Current	I_q			3	mA	$T_J=+25^\circ C$
Quiescent Current Change	ΔI_q			1	mA	$-27V \leq V_i \leq -38V$
				0.5	mA	$5mA \leq I_o \leq 1A$
Output Noise Voltage	V_N		400		μV	$10Hz \leq f \leq 100kHz, T_J=+25^\circ C$
Ripple Rejection	RR	54	60		dB	$\Delta V_i=10V, f=120Hz,$
Dropout Voltage	V_D		1.1		V	$I_o=1A, \Delta V_o=100mV, T_J=+25^\circ C$
Short Circuit Current	I_{sc}		1.1		A	
Peak Current	I_{pk}		2.2		A	$T_J=+25^\circ C$
Temperature Coefficient of V_D	$\Delta V_o/\Delta T$		-1		$mV/^\circ C$	$I_o=5mA$

Note:1. Load and line regulation are specified at constant junction temperature. Change in V_o due to heating effects must be taken into account separately. Pulse testing with low duty is used.

PLASTIC-ENCAPSULATE VOLTAGE REGULATORS

Typical Characteristics

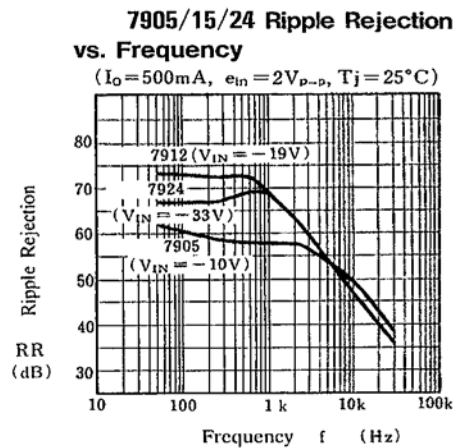
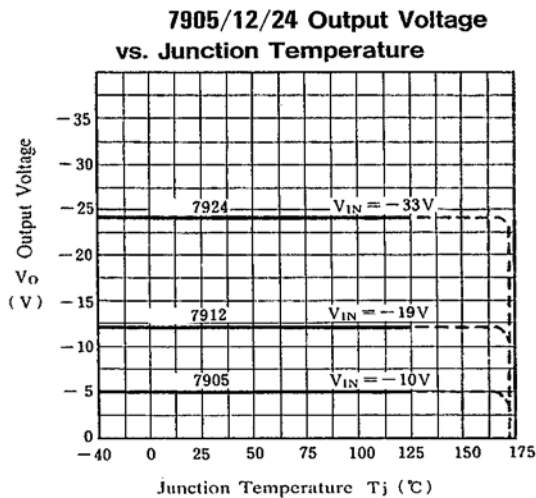
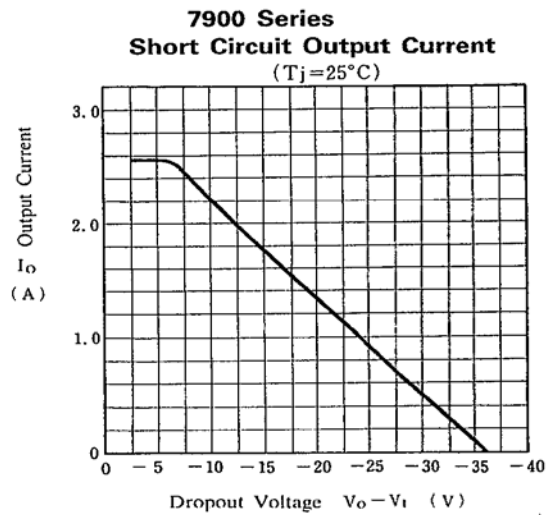
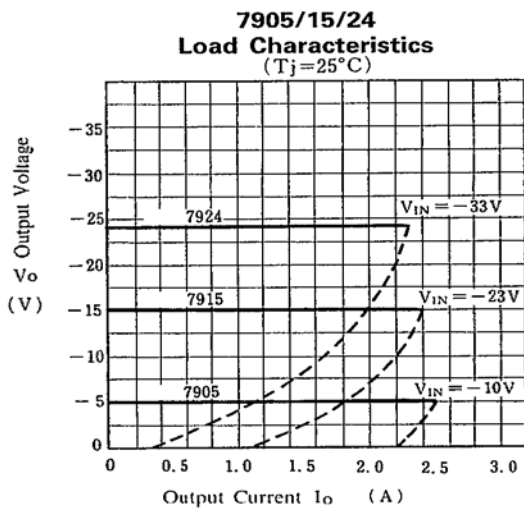
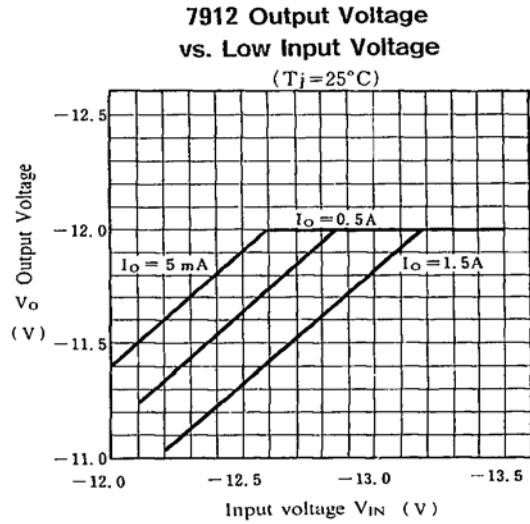
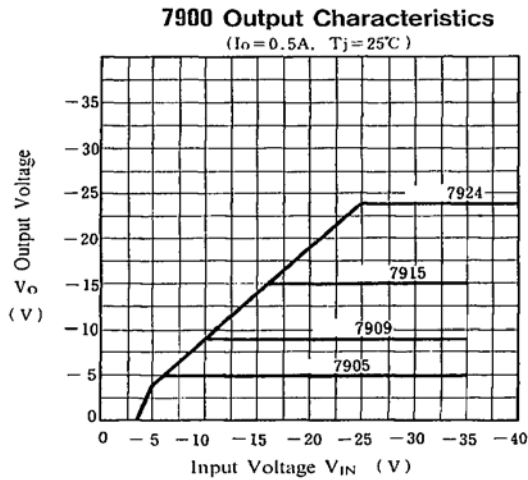

PLASTIC-ENCAPSULATE VOLTAGE REGULATORS

7905 Dropout Characteristics

($T_j = 25^\circ\text{C}$)

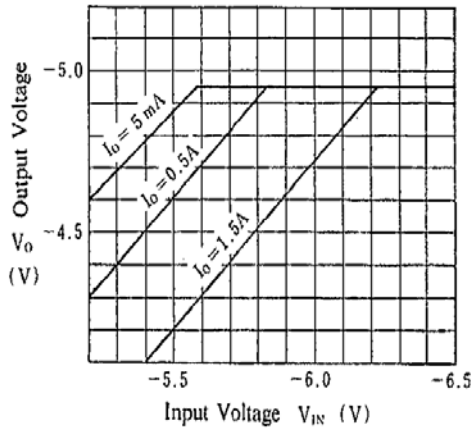

7905 Output Voltage vs. Temperature

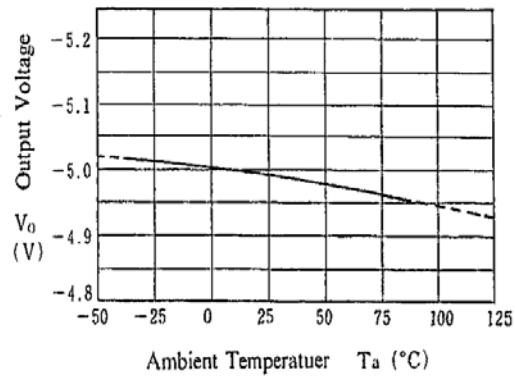

Quiescent Current vs. Input Voltage

($I_o = 0\text{ mA}$, $T_j = 25^\circ\text{C}$)

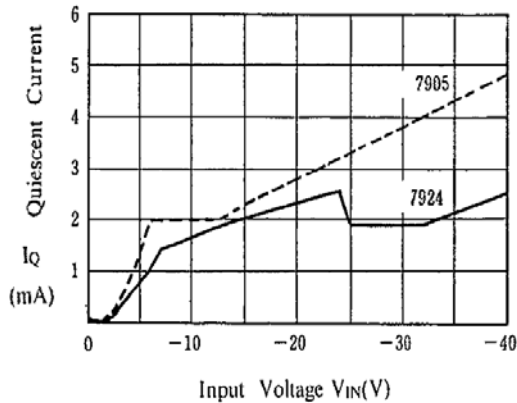

Power Dissipation vs. Ambient Temperature

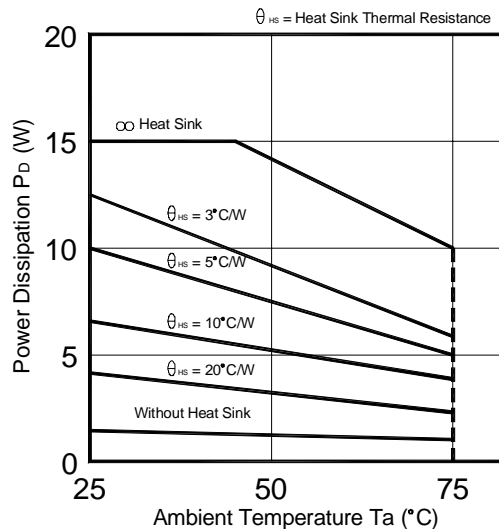

PLASTIC-ENCAPSULATE VOLTAGE REGULATORS

TO-252 Package Outline Dimensions

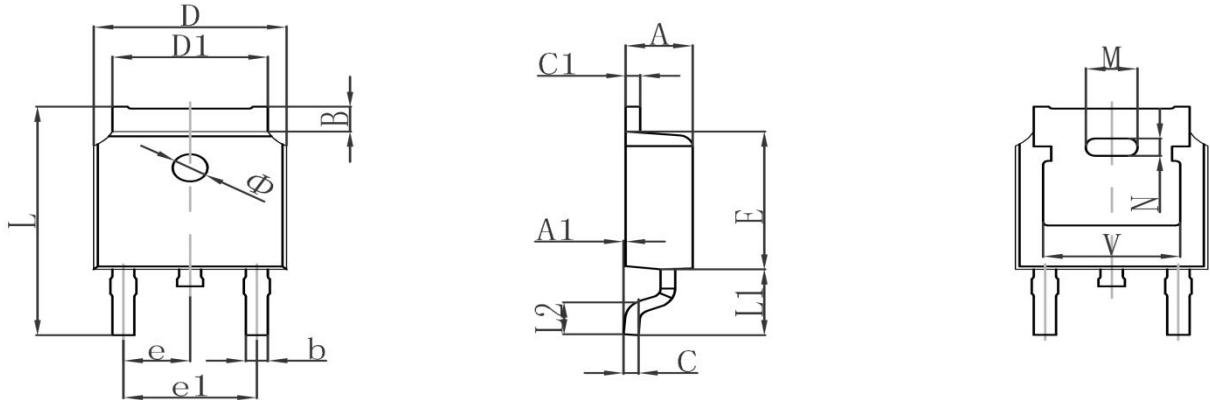

Symbol	Dimensions In Millimeters		Dimensions In Inches	
	Min.	Max.	Min.	Max.
A	2.200	2.380	0.087	0.094
A1	0.000	0.100	0.000	0.004
B	0.800	1.400	0.031	0.055
b	0.710	0.810	0.028	0.032
c	0.460	0.560	0.018	0.022
c1	0.460	0.560	0.018	0.022
D	6.500	6.700	0.256	0.264
D1	5.130	5.460	0.202	0.215
E	6.000	6.200	0.236	0.244
e	2.286TYP		0.090TYP	
e1	4.327	4.727	0.170	0.186
M	1.778REF		0.070REF	
N	0.762REF		0.018REF	
L	9.800	10.400	0.386	0.409
L1	2.9REF		0.114REF	
L2	1.400	1.700	0.055	0.067
V	4.830REF		0.190REF	
Φ	1.100	1.300	0.043	0.051

TO-252 Suggested Pad Layout

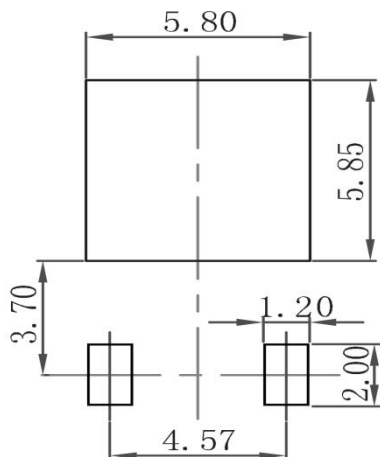

Note:

1. Controlling dimension: in millimeters
2. General tolerance: ±0.05mm
3. The pad layout is for reference purposes only

PLASTIC-ENCAPSULATE VOLTAGE REGULATORS

TO-252 Tape and Reel

TO-252 Embossed Carrier Tape

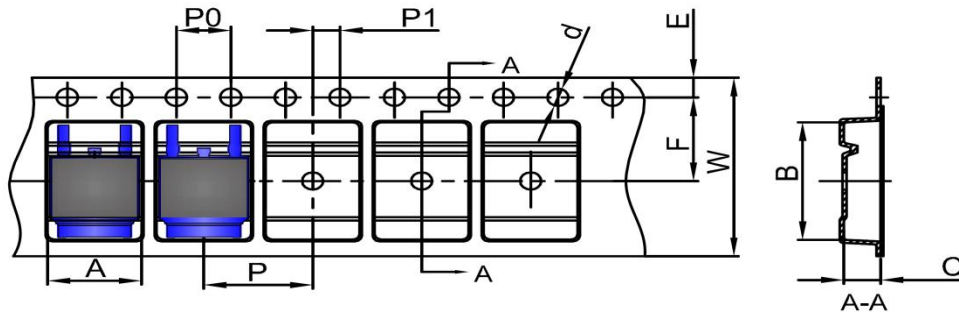

DIMENSIONS ARE IN MILLIMETER										
TYPE	A	B	C	d	E	F	P0	P	P1	W
TO-252	6.90	10.50	2.70	Ø1.55	1.75	7.50	4.00	8.00	2.00	16.00
TOLERANCE	±0.1	±0.1	±0.1	±0.1	±0.1	±0.1	±0.1	±0.1	±0.1	±0.1

TO-252 Tape Leader and Trailer

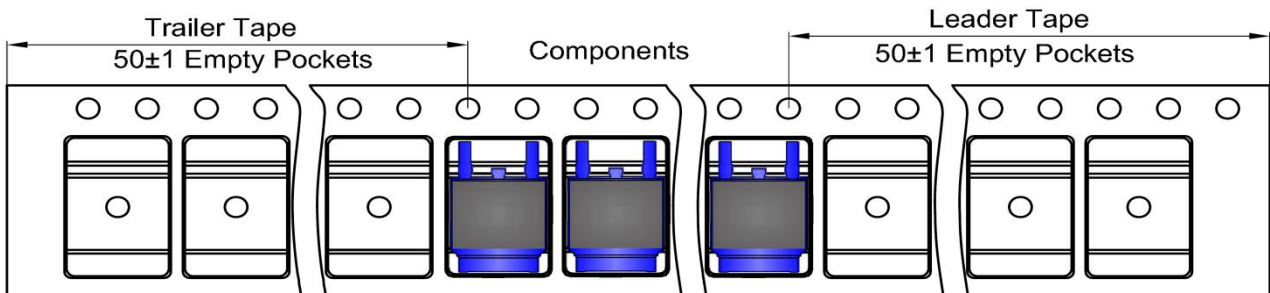

TO-252 Reel

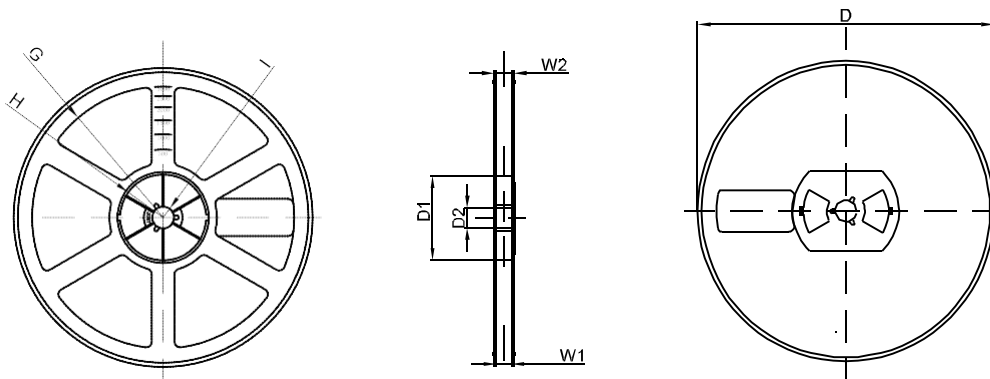

DIMENSIONS ARE IN MILLIMETER								
REEL OPTION	D	D1	D2	G	H	I	W1	W2
13" DIA	Ø330.00	100.00	Φ21.00	R151.00	R56.00	R6.50	16.40	21.00
TOLERANCE	±2	±1	±1	±1	±1	±1	±1	±1