

Pin Header Series

KLS1-207 PIN HEADER 2.54mm(0.100") Straight Pin Type

Electrical Characteristics:

Current Rating: 1 AMP
 Insulator Resistance: 5000MΩmin. at DC 500V
 Contact Resistance: 20mΩmax. at DC 100mA
 Operating Temperature: -45°C~+105°C

Material:

Housing: 30% Glass filled PBT UL94V-0
 Contacts: Brass
 Plating: Selective gold plated : gold plated on mating area and nickel plated on wire Cutting area
 Gold plated: 0.8u " over 50u " nickel
 Tin plated: 100u " over 50u " nickel

Features:

- * Available in straight and right angle.
- * Side-to-side and end-to-end stackable.
- * Custom design offered.

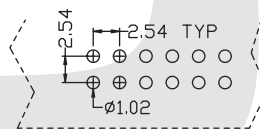
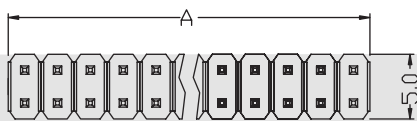
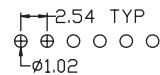
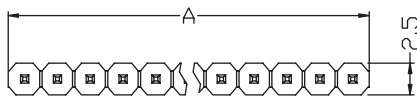
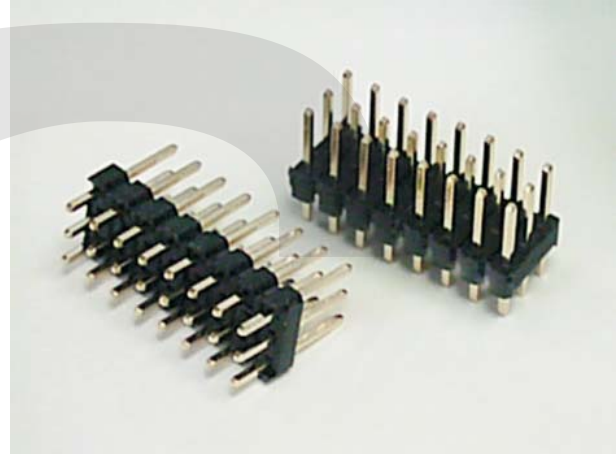

P. C. B Layout

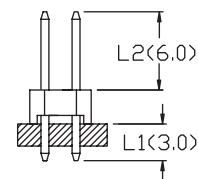
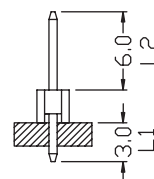
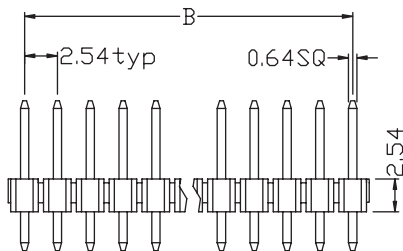

Position	1 Thru 40
Dimension	2 Thru 80
A±0.20	2.54xN
B±0.15	2.54xN-2.54

ORDER INFORMATION

Product No.: KLS1-207-1-XX-S

Pos. No. _____ Tail Style: S=Straight Pin R=Right Pin T=SMT Pin
 2.54mm Pin Header Series _____ Total pin number: XX=01-80Pin
 _____ 1-Single layer 2=Double layer

Pin Header Series

KLS1-207 PIN HEADER 2.54mm(0.100") Right Pin Type

Electrical Characteristics:

Current Rating: 1 AMP
 Insulator Resistance: 5000MΩmin. at DC 500V
 Contact Resistance: 20mΩmax. at DC 100mA
 Operating Temperature: -45°C~+105°C

Material:

Housing: 30% Glass filled PBT UL94V-0
 Contacts: Brass
 Plating: Selective gold plated : gold plated on mating area and nickel plated on wire Cutting area
 Gold plated: 0.8u " over 50u " nickel
 Tin plated: 100u " over 50u " nickel

Features:

- * Available in straight and right angle.
- * Side-to-side and end-to-end stackable.
- * Custom design offered.

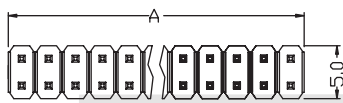
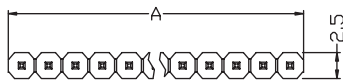
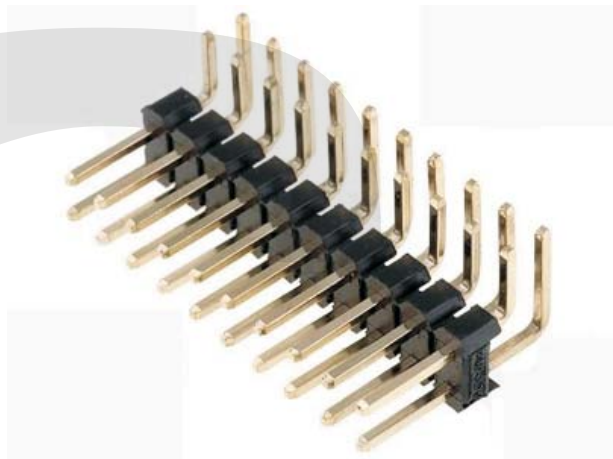

Position	1 Thru 40
Dimension	2 Thru 80
A±0.20	2.54xN
B±0.15	2.54xN-2.54

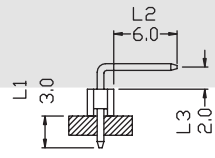
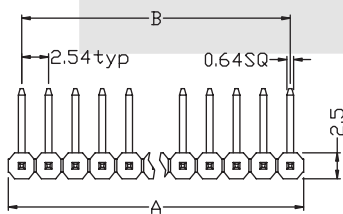

R1 TYPE

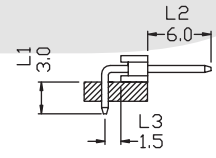

R2 TYPE

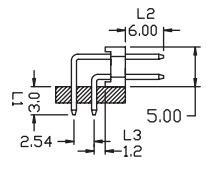
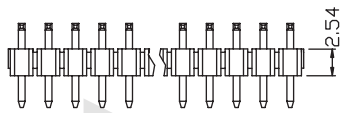
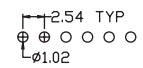

R1 TYPE

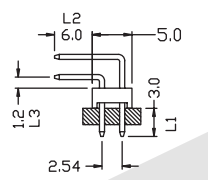

R2 TYPE

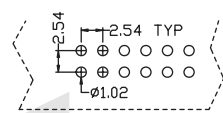

P. C. B Layout

ORDER INFORMATION

Product No.: KLS1-207-1-XX-R 1

Pos. No. _____ Right Pin Type
 2.54mm Pin Header Series _____ Tail Style: S=Straight Pin R=Right Pin T=SMT Pin
 1-Single layer 2-Double layer _____ Total pin number: XX=01-80Pin

Pin Header Series

KLS1-207 PIN HEADER 2.54mm(0.100") Single layer SMT Pin Type

Electrical Characteristics:

Current Rating: 1 AMP
Insulator Resistance: 5000MΩmin. at DC 500V
Contact Resistance: 20mΩmax. at DC 100mA
Operating Temperature: -45°C~+105°C

Material:

Housing: 30% Glass filled PBT UL94V-0
Contacts: Brass
Plating: Selective gold plated : gold plated on mating area and nickel plated on wire Cutting area
Gold plated: 0.8u " over 50u " nickel
Tin plated: 100u " over 50u " nickel

Features:

- * Available in straight and right angle.
- * Side-to-side and end-to-end stackable.
- * Custom design offered.

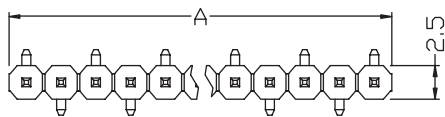
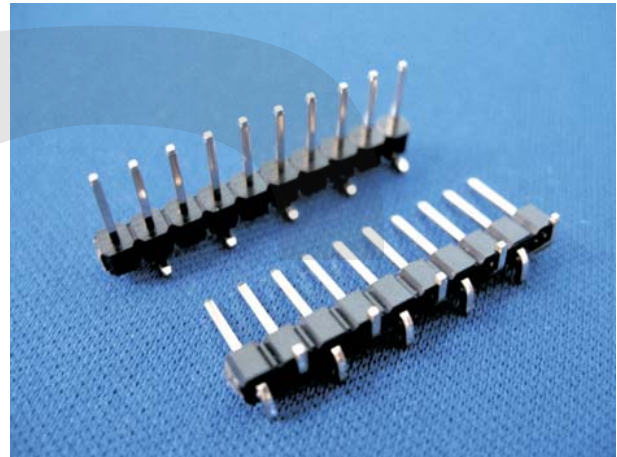

T1 TYPE

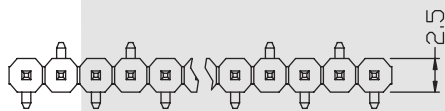
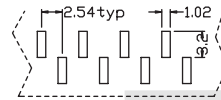

T2 TYPE

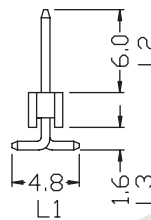
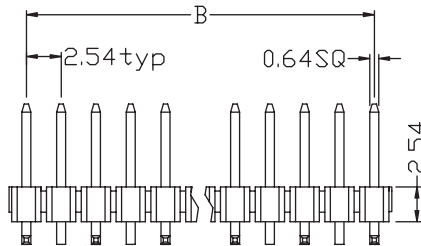
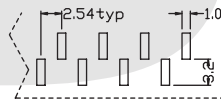

Position	1 Thru 40
Dimension	2 Thru 80
A±0.20	2.54xN
B±0.15	2.54xN-2.54

ORDER INFORMATION

Product No.: KLS1-207-1-XX-T 1

Pos. No. _____ SMT Pin Type
2.54mm Pin Header Series _____ Tail Style: S=Straight Pin R=Right Pin T=SMT Pin
1-Single layer 2-Double layer _____ Total pin number: XX=01-80Pin

Pin Header Series

KLS1-207 PIN HEADER 2.54mm(0.100") Double layer SMT Pin Type

Electrical Characteristics:

Current Rating: 1 AMP
 Insulator Resistance: 5000MΩmin. at DC 500V
 Contact Resistance: 20mΩmax. at DC 100mA
 Operating Temperature: -45°C~+105°C

Material:

Housing: 30% Glass filled PBT UL94V-0
 Contacts: Brass
 Plating: Selective gold plated : gold plated on mating area and nickel plated on wire Cutting area
 Gold plated: 0.8u " over 50u " nickel
 Tin plated: 100u " over 50u " nickel

Features:

- * Available in straight and right angle.
- * Side-to-side and end-to-end stackable.
- * Custom design offered.

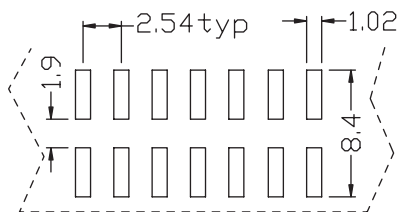
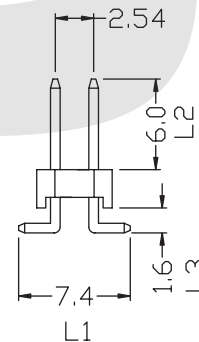
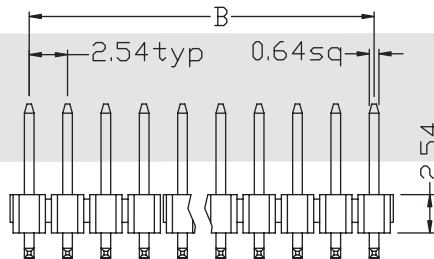
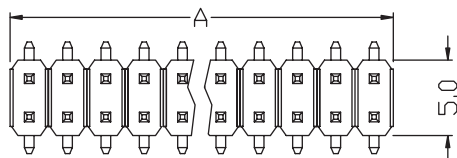
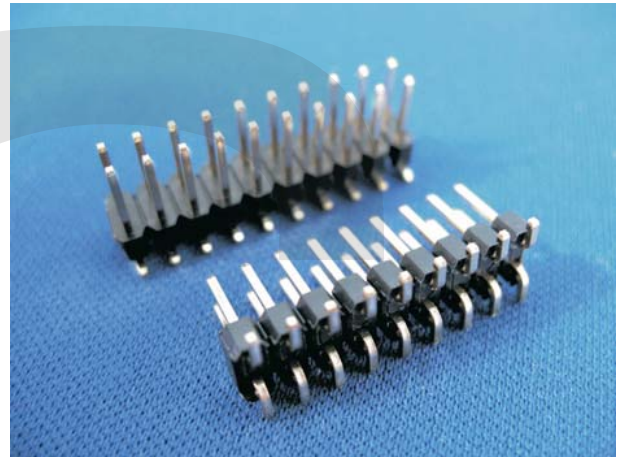

P.C.B Layout

Position	1 Thru 40
Dimension	2 Thru 80
A±0.20	2.54xN
B±0.15	2.54xN-2.54

ORDER INFORMATION

Product No.: KLS1-207-2-XX-T

Pos. No. _____ Tail Style: S=Straight Pin R=Right Pin T=SMT Pin
 2.54mm Pin Header Series _____ Total pin number: XX=02-80Pin
 _____ 1-Single layer 2-Double layer

Pin Header Series

KLS1-207 PIN HEADER 2.54mm(0.100") Double layer SMT Pin Type

Electrical Characteristics:

Current Rating: 1 AMP
Insulator Resistance: 5000MΩmin. at DC 500V
Contact Resistance: 20mΩmax. at DC 100mA
Operating Temperature: -45°C~+105°C

Material:

Housing: 30% Glass filled PBT UL94V-0
Contacts: Brass
Plating: Selective gold plated : gold plated on mating area and nickel plated on wire Cutting area
Gold plated: 0.8u " over 50u " nickel
Tin plated: 100u " over 50u " nickel

Features:

- * Available in straight and right angle.
- * Side-to-side and end-to-end stackable.
- * Custom design offered.

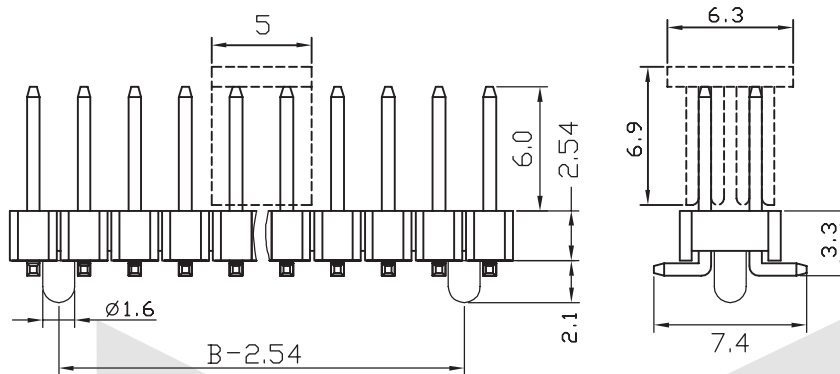
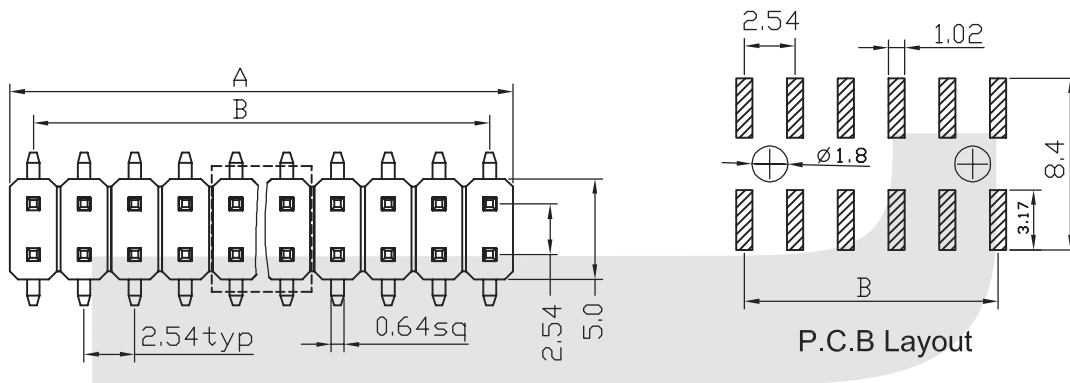

Position	1 Thru 40
Dimension	2 Thru 80
A±0.20	2.54xN
B±0.15	2.54xN-2.54

ORDER INFORMATION

Product No.: KLS1-207-2-XX-T 3

