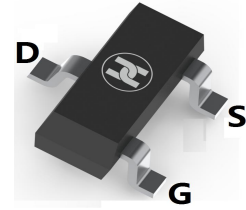
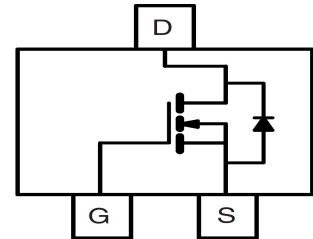

LOW VOLTAGE MOSFET (N-CHANNEL)
FEATURES

- Ultra low on-resistance: $V_{DS}=30V, R_{DS(ON)} \leq 52m\Omega @ V_{GS}=10V, I_D=3A$
- For PWM application
- For Load switch application
- Surface Mount device

SOT-23

MECHANICAL DATA

- Case: SOT-23
- Case Material: Molded Plastic. UL flammability
- Classification Rating: 94V-0
- Weight: 0.008 grams (approximate)

MAXIMUM RATINGS ($T_A = 25^\circ C$ unless otherwise noted)

Parameter	Symbol	Value	Unit
Drain-source voltage	V_{DS}	30	V
Gate-source voltage	V_{GS}	± 12	V
Continuous drain current	$T_A=25^\circ C$	I_D	3
	$T_A=70^\circ C$	I_D	2.2
Pulsed drain current	I_{DM}^*	10	A
Power dissipation	$T_A=25^\circ C$	P_D	1.40
	$T_A=70^\circ C$	P_D	0.9
Thermal resistance from Junction to ambient	$R_{\theta JA}$	125	$^\circ C/W$
Junction temperature	T_J	150	$^\circ C$
Storage temperature	T_{STG}	-55 ~ +150	$^\circ C$

ELECTRICAL CHARACTERISTICS ($T_A = 25^\circ C$ unless otherwise specified)

Parameter	Symbol	Min	Typ	Max	Unit	Conditions
Drain-Source breakdown voltage	$V_{(BR)DSS}^*$	30			V	$V_{GS}=0V, I_D=250\mu A$
Zero gate voltage drain current	I_{DSS}^*			1	μA	$V_{DS}=30V, V_{GS}=0V$
Gate-body leakage current	I_{GSS}^*			± 100	nA	$V_{DS}=0V, V_{GS}=\pm 12V$
Gate-threshold voltage	$V_{GS(th)}^*$	0.6	0.9	1.5	V	$V_{DS}=V_{GS}, I_D=250\mu A$
Drain-source on-resistance)	$R_{DS(ON)}^*$		35	47	m Ω	$V_{GS}=10V, I_D=3A$
			38	51	m Ω	$V_{GS}=4.5V, I_D=2A$
On-State Drain Current	$I_{D(ON)}$	10			A	$V_{DS}=5V, V_{GS}=10V$
Forward transconductance	g_{FS}		14		S	$V_{DS}=5V, I_D=3.0A$
Gate resistance	R_g	2.1	4.3	6.5	Ω	$V_{GS}=0V, V_{DS}=0V, f=1MHz$
Input capacitance	C_{iss}	185	235	285	pF	$V_{DS}=15V, V_{GS}=0V, f=1MHz$
Output capacitance	C_{oss}	25	35	45	pF	
Reverse transfer capacitance	C_{rss}	10	18	25	pF	
Turn-on delay time	$t_{d(on)}$		3.5		nS	$V_{DS}=15V, V_{GS}=10V, R_{GEN}=3\Omega, R_L=3.75\Omega$
Turn-on rise time	t_r		1.5		nS	
Turn-off delay time	$t_{d(off)}$		17.5		nS	
Turn-off fall time	t_f		2.5		nS	
Total gate charge	Q_g		10	12	nC	$V_{DS}=15V, V_{GS}=10V, I_D=3A$
Gate-source charge	Q_{gs}		0.95		nC	
Gate-drain charge	Q_{gd}		1.6		nC	
Diode forward voltage	V_{SD}		0.75	1	V	$I_S=1A, V_{GS}=0V$
Diode forward current	I_S			1.5	A	
Body Diode Reverse Recovery Time	t_{rr}		8.5	11	nS	$I_F=4A, dI/dt=100A/\mu s$
Body Diode Reverse Recovery Charge	Q_{rr}		2.6	3.5	nC	$I_F=4A, dI/dt=100A/\mu s$

*Pulse test ; Pulse width $\leq 300\mu s$, Duty cycle $\leq 0.5\%$.

LOW VOLTAGE MOSFET (N-CHANNEL)

Typical Characteristics

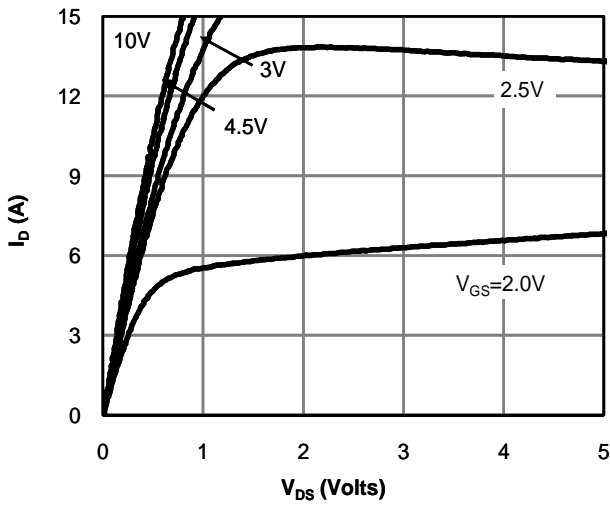

Fig 1: On-Region Characteristics

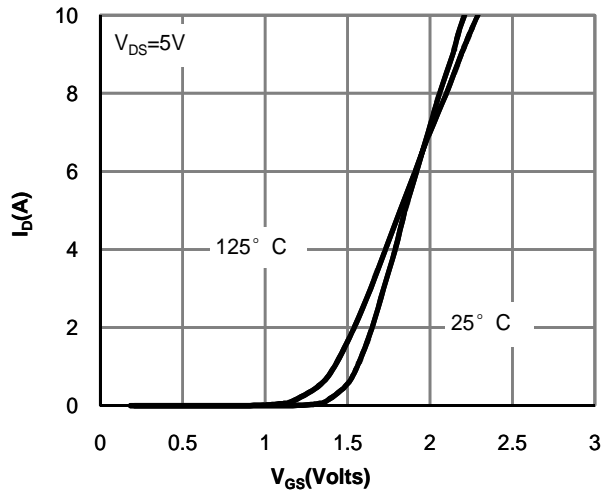

Figure 2: Transfer Characteristics

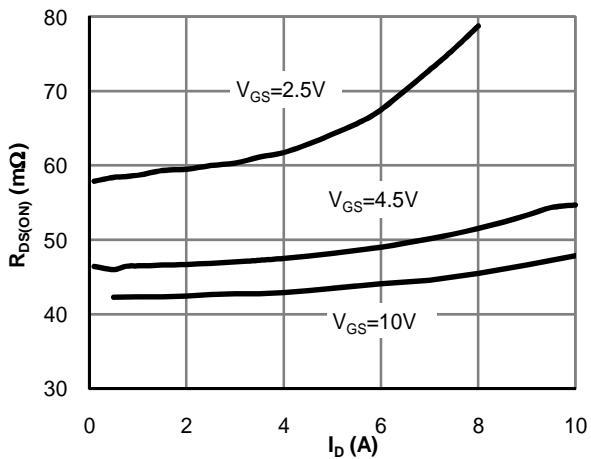

Figure 3: On-Resistance vs. Drain Current and Gate Voltage

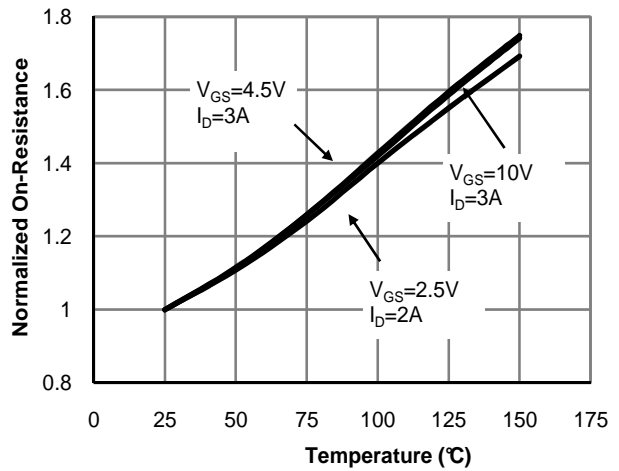

Figure 4: On-Resistance vs. Junction Temperature

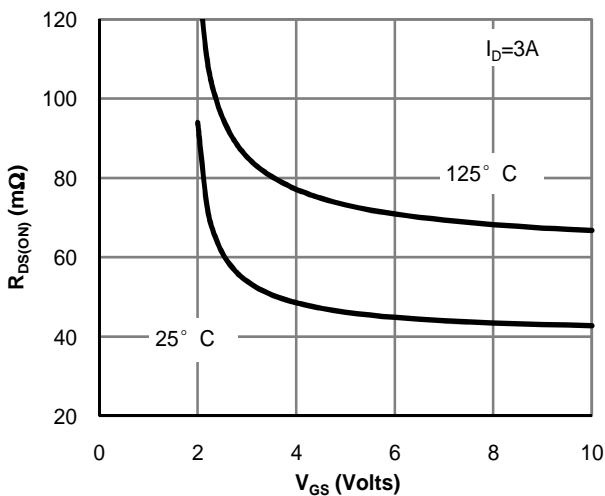

Figure 5: On-Resistance vs. Gate-Source Voltage

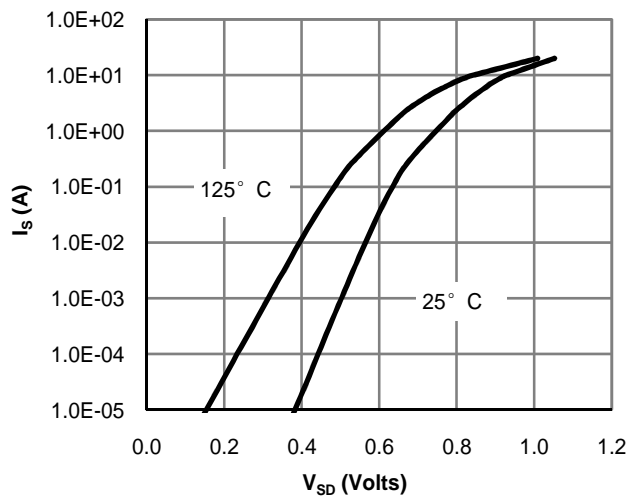

Figure 6: Body-Diode Characteristics

LOW VOLTAGE MOSFET (N-CHANNEL)

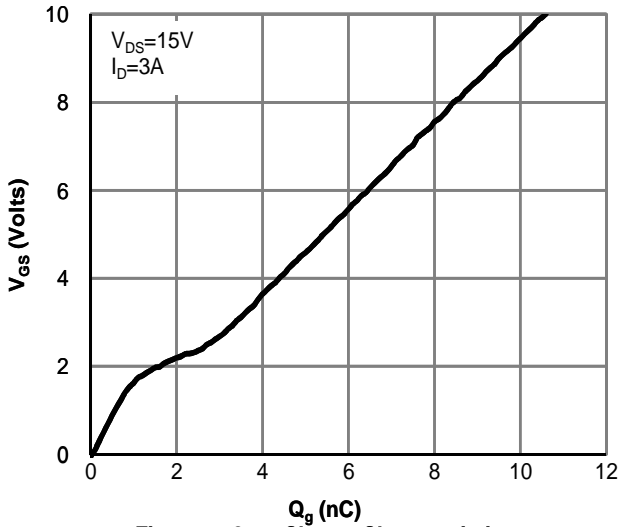

Figure 7: Gate-Charge Characteristics

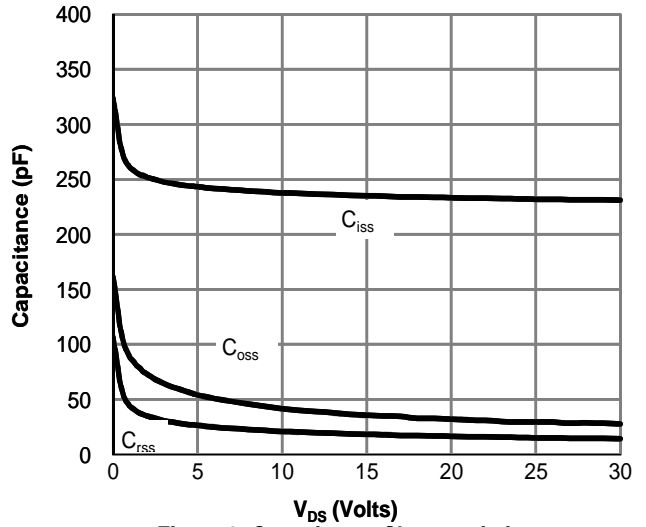

Figure 8: Capacitance Characteristics

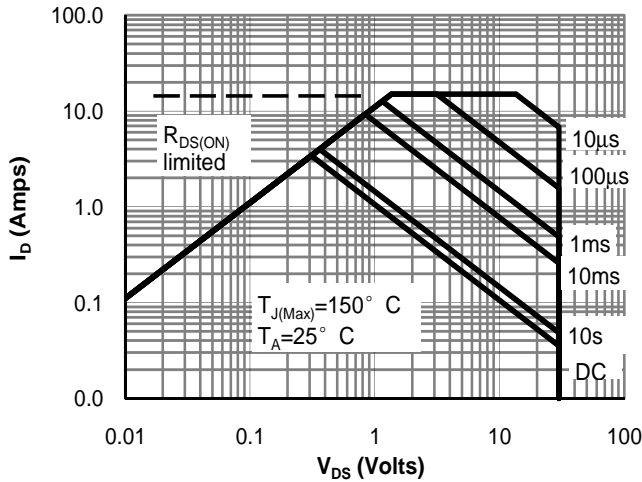

Figure 9: Maximum Forward Biased Safe Operating Area

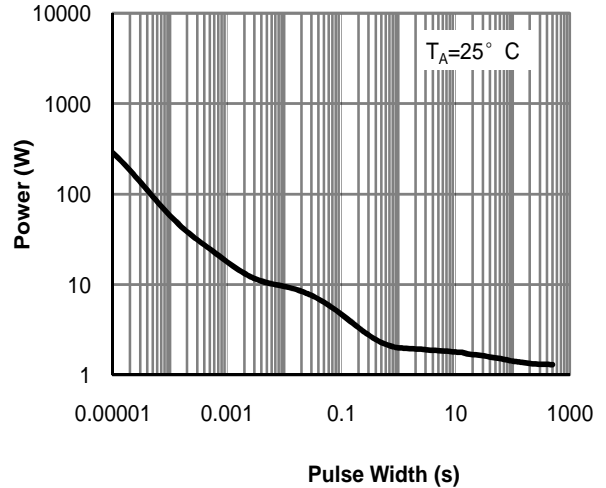

Figure 10: Single Pulse Power Rating Junction-to-Ambient

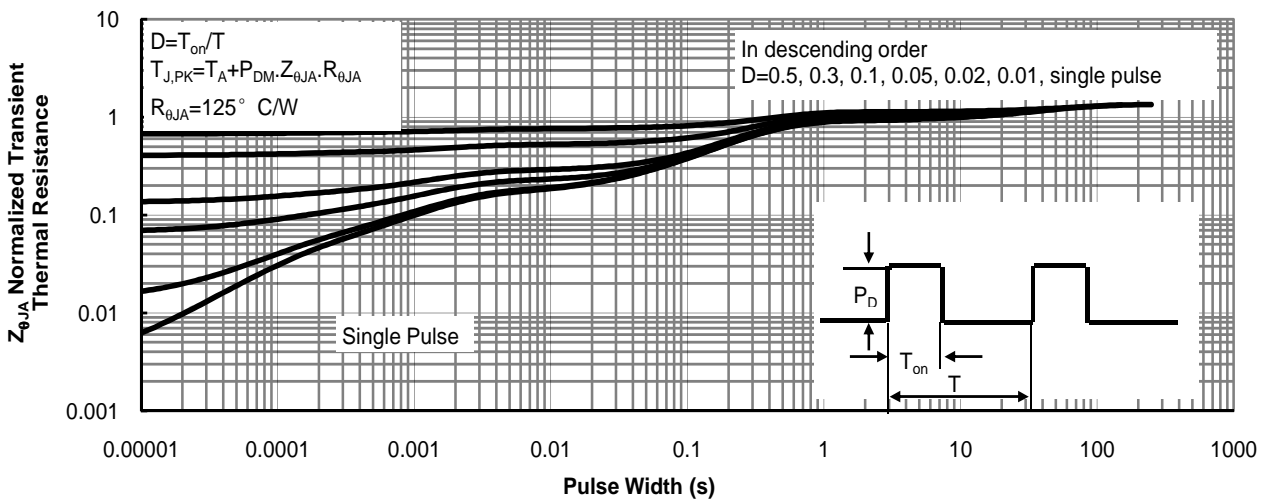
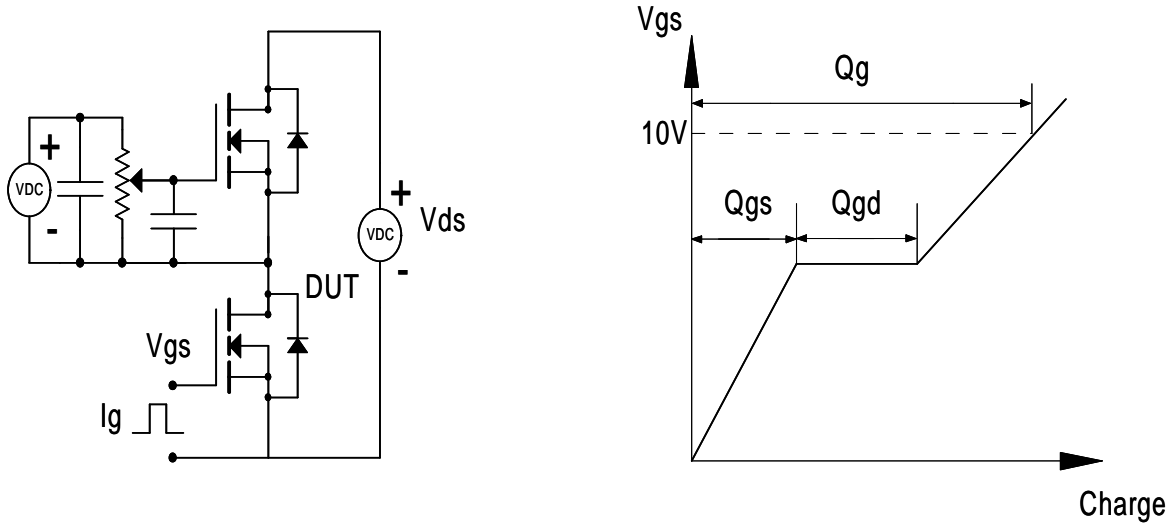

Figure 11: Normalized Maximum Transient Thermal Impedance

LOW VOLTAGE MOSFET (N-CHANNEL)

Gate Charge Test Circuit & Waveform



Resistive Switching Test Circuit & Waveforms

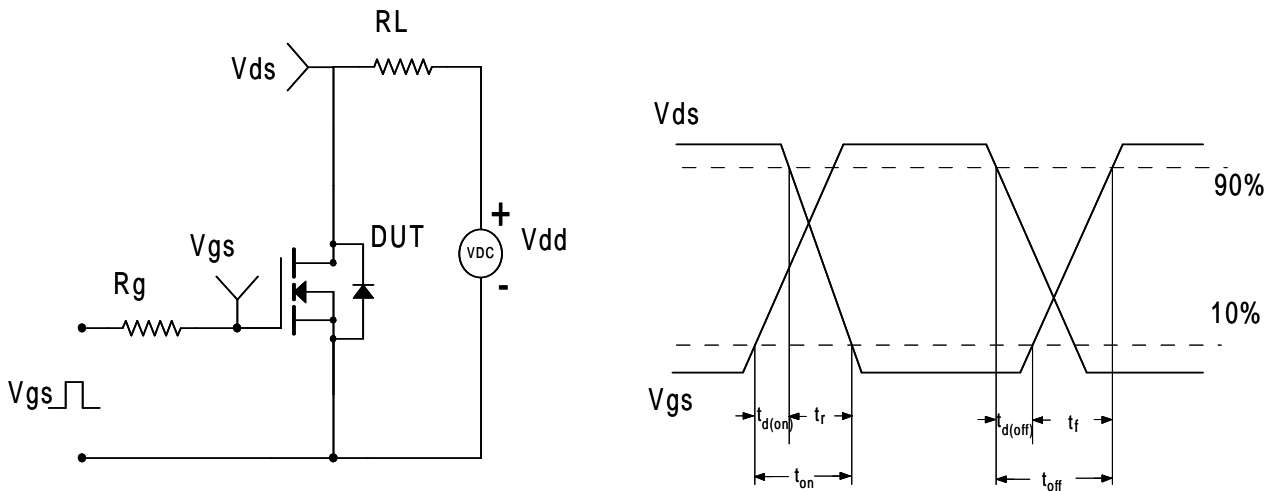

Diode Recovery Test Circuit & Waveforms

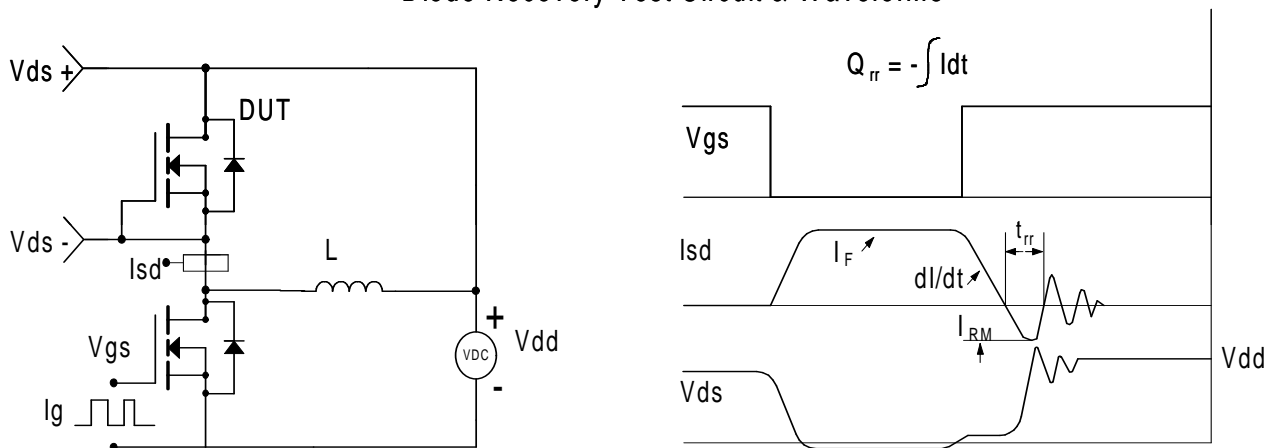

LOW VOLTAGE MOSFET (N-CHANNEL)
SOT-23 Package Outline Dimensions

Symbol	Dimensions In Millimeters		Dimensions In Inches	
	Min.	Max.	Min.	Max.
A	0.900	1.150	0.035	0.045
A1	0.000	0.100	0.000	0.004
A2	0.900	1.050	0.035	0.041
b	0.300	0.500	0.012	0.020
c	0.080	0.150	0.003	0.006
D	2.800	3.000	0.110	0.118
E	1.200	1.400	0.047	0.055
E1	2.250	2.550	0.089	0.100
e	0.950 TYP		0.037 TYP	
e1	1.800	2.000	0.071	0.079
L	0.550 REF		0.022 REF	
L1	0.300	0.500	0.012	0.020
θ	0°	8°	0°	8°

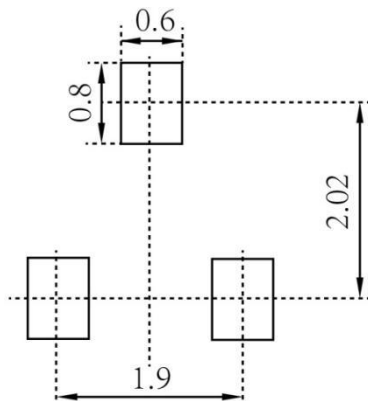
SOT-23 Suggested Pad Layout

Note:

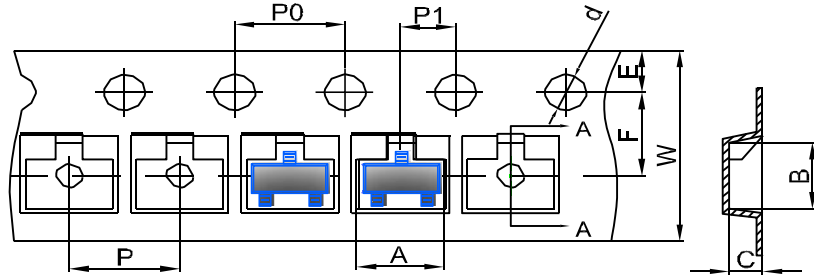
1. Controlling dimension: in millimeters
2. General tolerance: $\pm 0.05\text{mm}$
3. The pad layout is for reference purposes only

LOW VOLTAGE MOSFET (N-CHANNEL)
SOT-23 Tape and Reel
SOT-23 Embossed Carrier Tape

DIMENSIONS ARE IN MILLIMETER										
TYPE	A	B	C	d	E	F	P0	P	P1	W
SOT-23	3.15	2.77	1.22	Ø1.50	1.75	3.50	4.00	4.00	2.00	8.00
TOLERANCE	±0.1	±0.1	±0.1	±0.1	±0.1	±0.1	±0.1	±0.1	±0.1	±0.1

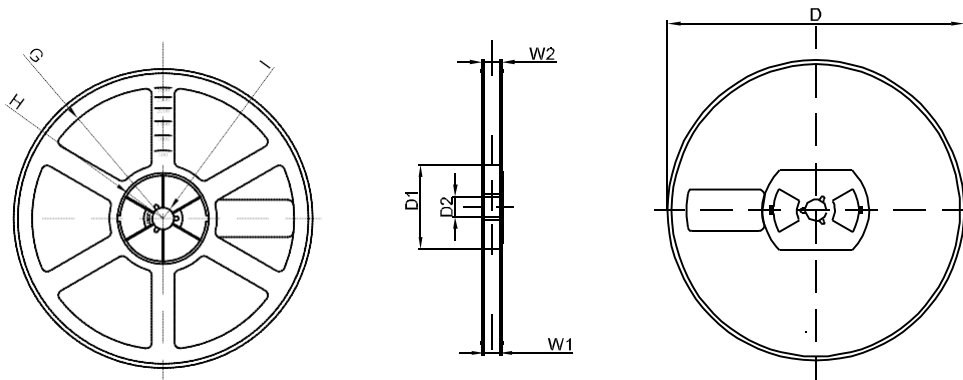
SOT-23 Tape Leader and Trailer

SOT-23 Reel

DIMENSIONS ARE IN MILLIMETER								
REEL OPTION	D	D1	D2	G	H	I	W1	W2
7" DIA	Ø178	54.40	13.00	R78	R25.60	R6.50	9.50	12.30
TOLERANCE	±2	±1	±1	±1	±1	±1	±1	±1