

# PRODUCT SPECIFICATION

## Model No.: FYL-3014SURC1A

Descriptions:
■ Dice material: AllnGaP.
■ Emitting Color: Super bright Red.
■ Device Outline: Φ3mm Round Type.
■ Lens Type: Water clear.



CUSTOMER APPROVED SIGNATURES	APPROVED BY	CHECKED BY	PREPARED BY

**NINGBO FORYARD OPTOELECTRONICS CO.,LTD.**

**Add:**NO.115 Qixin Road Ningbo Zhejiang China

**Zip:**315051

**Tel:** 0086-574-87933652 87927870 87922206

**Fax:** 0086-574-87927917

**E-mail:** Sales@foryard.com (General)

[Http://www.foryard.com](http://www.foryard.com)



■ Absolute maximum ratings(Ta=25 ° c)

Parameter	MAX.	Unit
Power Dissipation	75	mW
Peak Forward Current (1/10 Duty Cycle, 0.1ms Pulse Width)	100	mA
Continuous Forward Current	30	mA
Derating Linear From 50°C	0.4	mA/°C
Reverse Voltage	5	V
Operating Temperature Range	-40°C to +85°C	
Storage Temperature Range	-40°C to +100°C	
Lead Soldering Temperature[4mm(.157") From Body]	260°C for 5 Seconds	

■ Electrical and optical characteristics(Ta=25 ° c)

Parameter	Symbol	Min.	Typ.	Max.	Unit	Test Condition
Luminous Intensity	$I_v$	-	3000	-	mcd	$I_F=20mA$
Viewing Angle	$2\theta_{1/2}$	-	30	-	Deg	
Peak Emission Wavelength	$\lambda_p$	-	630	-	nm	
Dominant Wavelength	$\lambda_d$	620	625	630	nm	
Spectral Line Half-Width	$\Delta\lambda$	-	15	-	nm	
Forward Voltage	$V_F$	1.7	2.0	2.5	V	
Reverse Current	$I_R$			10	$\mu A$	$V_R=5V$

■ **Typical Electrical Characteristics Curves**  
**(25 °c Ambient Temperature Unless Otherwise Noted)**

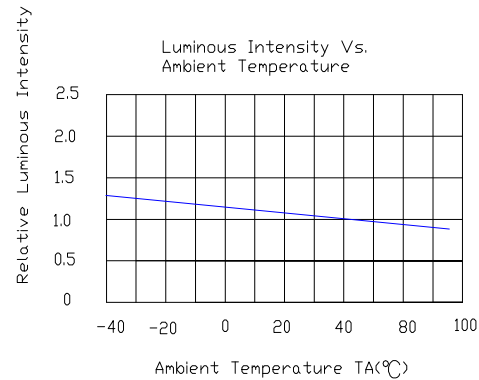
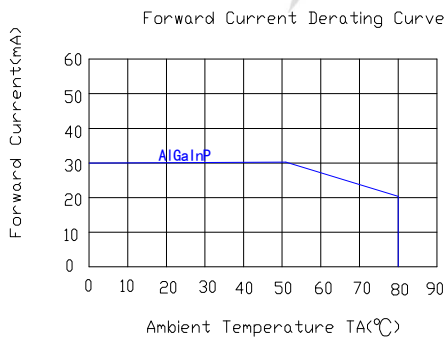
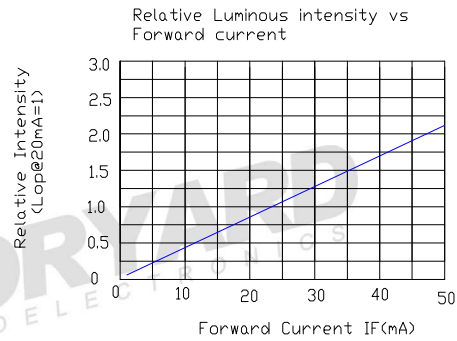
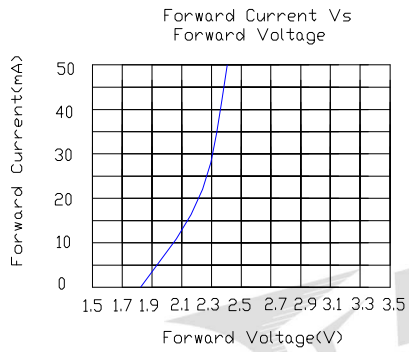
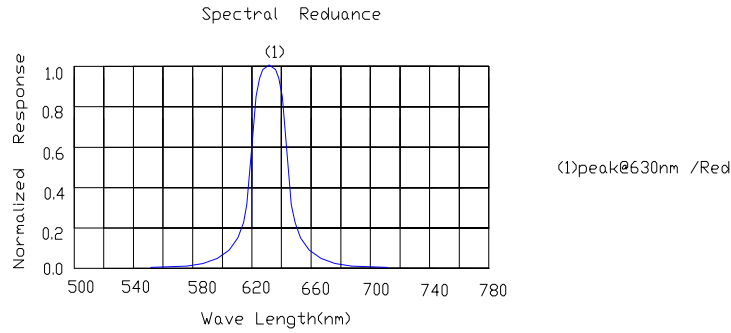

**Radiation pattern.**

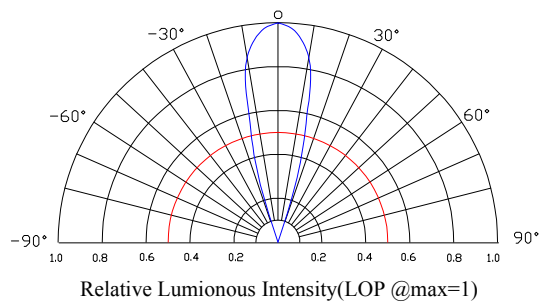

<b>Model No.</b>	FYL-3014SURC1A
<b>Rev.</b>	A

■ LAMP PACKING.

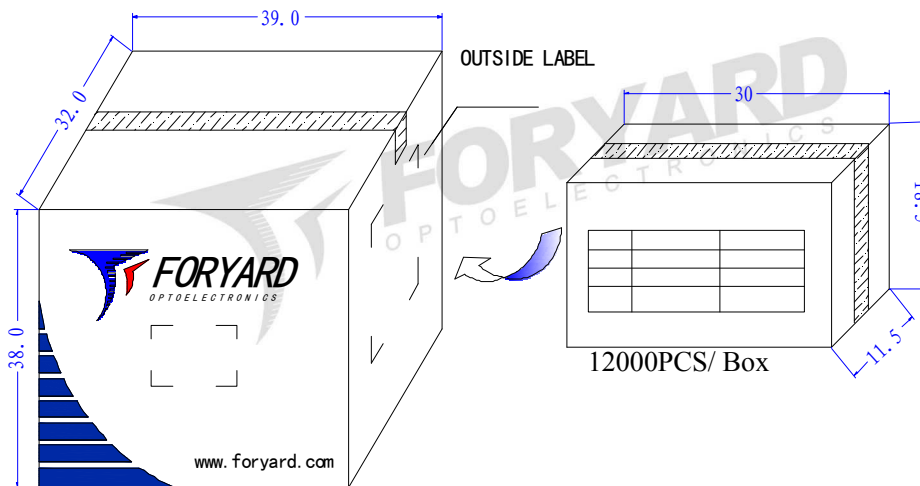
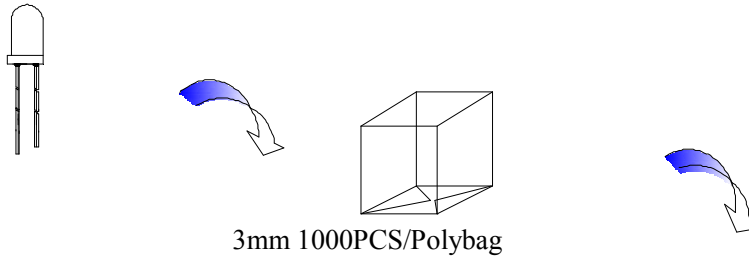

72000PCS/ Carton



OUTSIDE LABEL